



# Natural Hazards and Sustainability for Residential Buildings

FEMA P-798 / September 2010



FEMA



# Natural Hazards and Sustainability for Residential Buildings

FEMA P-798 / September 2010



**FEMA**

---

## Authors

David S. Gromala, Consultant, Principal Author

Omar Kapur, URS Corporation

Vladimir Kochkin, National Association of Home Builders Research Center

Philip Line, URS Corporation, Project Manager

Samantha Passman, URS Corporation

Adam Reeder, PBS&J

Wayne Trusty, Athena Sustainable Materials Institute

## Reviewers

Don Allen, Steel Framing Alliance

Wanda Edwards, Institute for Business and Home Safety

Gary Ehrlich, National Association of Home Builders

Simon Foo, Public Works and Government Services Canada

Caroline Frenette, Centre d'expertise sur la construction commerciale en bois (cecobois)

Claret Heider, National Institute of Building Sciences

Eric Letvin, URS Corporation, Program Manager

Randy Melvin, Winchester Homes

Janice Olshesky, Olshesky Design Group, LLC

Susan Patton, URS Corporation

Kevin Reinertson, California Office of the State Fire Marshal

Mike Rimoldi, Federal Alliance for Safe Homes

Tona Rodriguez-Nikl, Oregon State University

Paul Tertell, FEMA

Frances Yang, ARUP

## Acknowledgments

Lee-Ann Lyons, URS Corporation, Layout Designer

Billy Ruppert, URS Corporation, Illustrator

# Executive Summary



Sustainable building design concepts are increasingly being incorporated into residential building design and construction through green building rating systems. While the environmental benefits associated with adopting green building practices can be significant, these practices must be implemented in a manner that does not compromise the building's resistance to natural hazards, such as high winds, earthquakes, floods, or wildfires.

This document examines current green building rating systems in a broader context. It identifies green building practices—the tools of today's green building rating systems—that are different from historical residential building practices and that, unless implemented with an understanding of their interactions with the rest of the structure, have the potential to compromise a building's resistance to natural hazard events. This document discusses how to retain or improve natural hazard resistance while incorporating these green building practices. While most common green building practices provide sustainability advantages with little or no effect on structural performance or durability, others require reevaluation of the building's structural design or detailing to retain its integrity during natural hazard events. Often, only minimal design modifications are required to maintain natural hazard resistance.

Understanding interactions between green building practices and natural hazards will benefit users—particularly designers, builders, code officials, and those who develop green building rating systems, codes, and standards—by providing a perspective that green building practices, while important on their own, must be part of a larger context that encompasses life safety, disaster resistance, and other related considerations.



# Table of Contents

Executive Summary .....	ES-1
Section 1: Introduction .....	1-1
Section 2: Green Building Rating Systems, Codes, and Standards .....	2-1
2.1 Defining Green Building Performance Levels .....	2-2
2.1.1 Green Building Categories in ICC-700 .....	2-3
2.1.2 Relating Category Provisions to Performance .....	2-4
2.2 Green Building Rating Systems and the Building Codes .....	2-6
Section 3: Sustainable Building Design .....	3-1
3.1 Decision Process for Sustainable Building Design .....	3-3
3.2 Added Benefits of Sustainable Building Design .....	3-4
Section 4: Sustainability and Natural Hazards .....	4-1
4.1 Seismic Hazard .....	4-1
4.2 Wind Hazard .....	4-2
4.3 Flood Hazard .....	4-2
4.4 Wildfire Hazard .....	4-2
4.5 Green Building Practice Natural Hazard Sensitivity Matrix .....	4-2
Section 5: Examples of Green Building Practices and Natural Hazard Resistance .....	5-1
5.1 Example 1: Rooftop Solar Photo-Voltaic Panels .....	5-2
5.2 Example 2: Solar Shading Using Roof Overhangs .....	5-4
5.3 Example 3: Elevating a Structure Above the Base Flood Elevation – Material Minimization Considerations .....	5-7
Appendix A: Sustainability and Life Cycle Assessment .....	A-1
Appendix B: Acronyms .....	B-1
Appendix C: References and Resources .....	C-1

**List of Figures**

Figure 1: Summary of IgCC Regulatory Framework for Residential Construction ..... 2-2

Figure 2: Green Building Categories of ICC-700 ..... 2-3

Figure 3: Hazard Resistance Evaluation Process for Green Building Practices ..... 3-3

Figure 4: Example 1 – Installing a Roof-Mounted Solar Panel System ..... 5-2

Figure 5: Example 2 – Large Roof Overhang for Solar Shading ..... 5-4

Figure 6: Example 2 – Avoided Environmental Impacts for Two LCA Indicators ..... 5-6

Figure 7: Example 3 – House Elevated on Piles in Coastal Flood Zone A ..... 5-7

Figure 8: Example 3 – Building Plan ..... 5-8

Figure A1: Humanized Terms for One LCA Indicator for Example 2 House ..... A-4

**List of Tables**

Table 1: Green Building Practice Natural Hazard Sensitivity Matrix ..... 4-3

Table 2: Example 2 – Details for Adding Solar Shading Overhang ..... 5-5

Table 3: Details of Buildings for Example 3 – Building Elevation in Flood Zone ..... 5-9

Table 4: Sample National Flood Insurance Program Flood Insurance Premiums for  
Buildings in Zone A and Coastal Zone A ..... 5-9

Table A1: LCA Indicators for Example 2 House ..... A-3



# Introduction



The purpose of this document is to describe the interactions, both positive and negative, between common green building practices and the robustness of residential buildings to withstand natural hazards. Understanding these interactions will benefit users—particularly designers, builders, code officials, and homeowners—by providing a perspective that green building practices, while important on their own, must be part of a larger sustainable building design context that encompasses life safety, disaster resistance, and other related issues. Many hazard resistance issues are addressed in model building codes such as the International Residential Code (IRC). However, some of the building modifications introduced by green building practices create design, detailing, and installation challenges that are not covered by the IRC’s provisions. This document identifies specific areas in which special attention to a few small details will maintain or increase natural hazard resistance.

This document uses the terms “green building practices” and “sustainable building design” in a very specific context. The term **green building practices** commonly refers to products or practices implemented to achieve a level of environmental performance above a minimum or traditional design. This document focuses on practices that are assigned credit under a green building rating system. The term **sustainable building design** refers to a broader concept that includes not only fundamental sustainability principles, but also considers and addresses the risks associated with natural hazards. Other significant aspects of sustainability, such as societal issues and ecosystem health, are outside the scope of this discussion.

Voluntary green building rating systems are gradually being replaced by mandatory requirements in local and State jurisdictions. As mandatory green building requirements become more widespread, building designers, code officials, and builders will increasingly be faced with decisions on how to comply with applicable building code requirements while implementing the new green building

practices. As demonstrated later in this document, the implications of green building practices on the capability of buildings to resist natural hazards are not always evident.

The document provides an overview of existing residential green building rating systems in the United States (Section 2). It describes a range of common green building practices and their interactions with structural performance and durability (Section 3). Section 4 introduces specific concerns related to seismic, wind, flood, and wildfire and provides a summary table that ties several specific green building practices to design, detailing, and installation considerations to enable those practices to be implemented without compromising natural hazard resistance. To illustrate the concepts discussed in the document, Section 5 provides three examples:

- Example 1 illustrates some of the many interactions to be considered when incorporating a roof-mounted solar panel system in the home design.
- Example 2 illustrates that the increased loads associated with large roof overhangs (added for solar shading) can be resisted by adding a minimal amount of enhanced connectors into the building system. This example demonstrates the environmental benefits of retaining natural hazard resistance by quantifying those benefits using life cycle assessment (LCA) techniques (the LCA methodology is summarized in Appendix A).
- Example 3 illustrates the rapid financial payback for increasing, rather than minimizing, foundation framing material when elevating a building in a specific flood zone design case.

# Green Building Rating Systems, Codes, and Standards



There are several nationally recognized green building rating systems in the U.S. that apply to residential construction. The largest of these are the National Green Building Standard (ICC-700 [NAHB, 2008a, b]), promulgated jointly by the National Association of Home Builders and the International Code Council (ICC), and the “Leadership in Energy and Environmental Design (LEED) for Homes” rating system promulgated by U.S. Green Building Council (refer to references for Web site). It is anticipated that many of the local and regional residential green building programs in use today (described by Bowyer, 2010) will eventually convert to one of the national rating systems.

This document primarily uses the provisions of ICC-700 as the basis for examining common green building design practices for residential buildings and their interactions with sustainable building design for natural hazard resistance. ICC-700 was chosen because it is a nationally recognized consensus standard, and is referenced in the current draft of the ICC International Green Construction Code (IgCC [ICC, 2010 – publication anticipated in 2011]). It must be noted that the use of ICC-700 as the basis for discussion in this document is not intended to indicate a preference for ICC-700 relative to either LEED for Homes or any other green building rating system. A single reference document was chosen to maximize clarity in the discussions that follow.

The ICC IgCC will provide a new regulatory framework for introducing green building practices into the built environment. An outline of this framework specific to residential construction is

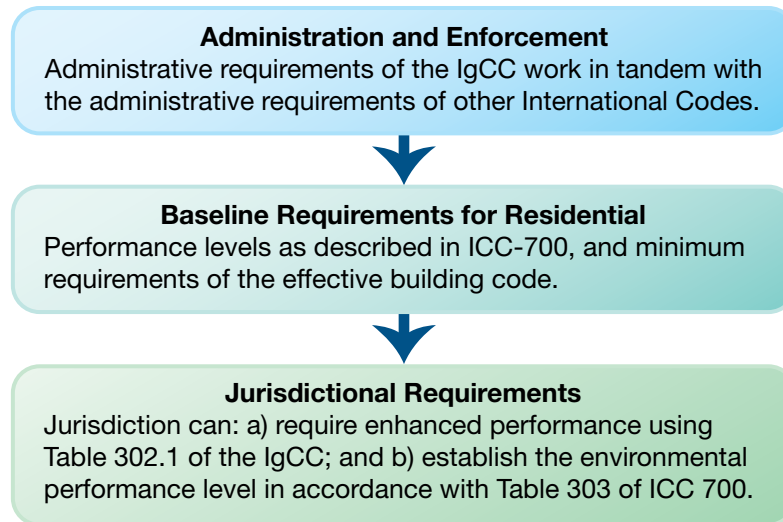

**Figure 1: Summary of IgCC Regulatory Framework for Residential Construction**

depicted in Figure 1. A key element of the IgCC is that it serves as an “overlay” code such that its provisions work with, rather than replace, provisions of other model codes that regulate building construction. Under this framework, green building practices are clearly understood as being in addition to other requirements of the International Codes.

## 2.1 Defining Green Building Performance Levels

Green building rating systems have various methods for establishing their requirements. Most have adopted a multi-tiered approach for defining levels of green performance. For example, achieving a specific threshold number of points under ICC-700 enables a building design to achieve a performance level of Bronze, Silver, Gold, or Emerald, where Emerald represents the highest performance level. Other programs, such as LEED for Homes, use a similar approach. In addition to the green performance attributes specifically identified by rating systems, a sustainable building design process should address questions (only some of which are covered by this document) related to whether the product or building practice degrades any performance attribute relative to the product or practice it is replacing; these questions include:

- Is the design as resilient or robust under extreme events (such as high winds, earthquakes, floods, fire)?
- Is it as durable under both normal and extenuating service conditions (such as high humidity or extreme temperatures)?
- Does it introduce any hidden dangers (such as increased chemical exposure)?
- Is it more sensitive to quality of installation (and the risks associated with imperfect installation)?

- Does it affect the performance, durability, or efficacy of adjacent materials or other portions of the structure (such as increasing corrosion rates of materials in contact with it)?
- Are there other unforeseen consequences of its use (such as changing internal building cavity moisture and temperature conditions, potentially leading to condensation and mold)?

Builders and homeowners will also ask two additional (practical) questions to determine whether the sustainability benefits of the green product or building practice are significant enough to justify its substitution in place of more familiar products or practices:

- How large are the environmental benefits (quantified by LCA or other measures)?
- What are the costs of implementation?

### 2.1.1 Green Building Categories in ICC-700

There are six green building categories included in ICC-700 (refer to Figure 2). Some provisions in ICC-700 address specific sustainability goals (e.g., improved energy efficiency garners increased rating system points). Other provisions discourage specific practices that negatively affect occupant health or the local environment (e.g., not permitting the use of materials with high

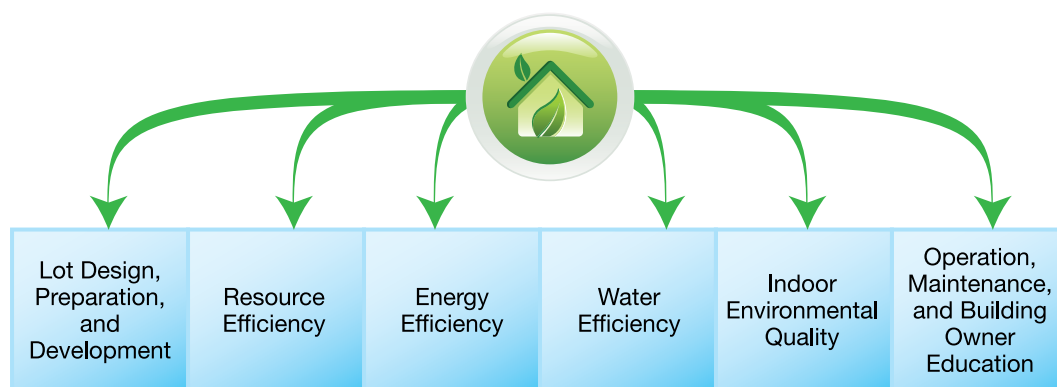

**Figure 2: Green Building Categories of ICC-700**

volatile organic compound [VOC] emissions). Still other provisions encourage considering a much broader perspective, such as cradle-to-grave impacts (e.g., providing credit for analyses that show life cycle benefits).

Points in each ICC-700 category are summed to arrive at the total number of points credited to achieve a performance level. Under this system, different numbers of points are assigned for various practices.

Within ICC-700, the relative balance of minimum number of points required to achieve the Bronze Level among the six categories is approximately as follows: lot design – 16 to 17 percent; resource efficiency – 19 to 20 percent; indoor environmental quality – 16 to 20 percent; energy efficiency – 13 to 17 percent; water efficiency – 6 to 8 percent; and operation and maintenance – 2 to 3 percent. In

### COMPARISON OF ICC-700 AND LEED FOR HOMES CATEGORIES

ICC-700 Categories	Corresponding LEED for Homes Categories
Lot Design, Preparation, and Development	<ul style="list-style-type: none"> <li>• Innovation and Design Process</li> <li>• Location and Linkages</li> <li>• Sustainable Sites</li> </ul>
Water Efficiency	Water Efficiency
Energy Efficiency	Energy and Atmosphere
Resource Efficiency	Materials and Resources
Indoor Environmental Quality	Indoor Environmental Quality
Operation, Maintenance, and Building Owner Education	Awareness and Education

In addition to these minimum points per category, additional points from any category—14 percent to 24 percent—must be acquired to meet a specific performance level.

Although this document focuses on the provisions of the ICC-700 rating system, many users will evaluate their residential buildings under the LEED for Homes rating system. Its eight evaluation categories correspond to the six ICC-700 categories shown in Figure 2 (refer to text box above).

## 2.1.2 Relating Category Provisions to Performance

When green building practices are being considered, their effect on the building’s natural hazard resistance must be evaluated as part of the building design process. Typically, three areas related to the proposed building modification must be examined:

1. Are any **design changes** required to maintain compliance with code provisions related to hazard mitigation specific to the region or to other aspects of structural performance and durability?
2. Are there any special **building detailing** issues that must be addressed?
3. Will any special **installation and maintenance** instructions need to be developed and communicated in the field?

While this document focuses on maintaining structural performance required by code, it is not intended to discourage designing to higher natural hazard resistance performance targets. Users choosing to invest in green may also choose to concurrently invest in added structural or durability performance.

The following discussion provides examples of specific green building practices in each ICC-700 category that are most likely to affect structural performance and durability. The categories of Water Efficiency and Indoor Environmental Quality, which have limited interaction with natural hazard resistance, are not included in this discussion.

## Lot Design, Preparation, and Development

**Beneficial interactions:** Green building practices that minimize slope disturbance, soil disturbance, and erosion can also significantly improve the resistance of a neighborhood to some natural hazards (such as earthquakes, some types of flooding, and wildfires). Further, development of stormwater management plans, hydrologic analysis and soil studies, and other such actions that garner points under ICC-700 can also guide the designer to solutions that increase a building's resistance to natural hazards.

**Special considerations:** Site selection decisions that qualify for green rating system points should also consider the dominant natural hazards in a region. For example, development of an infill site should include consideration of floodplain and stormwater management issues.

## Resource Efficiency

**Beneficial interactions:** Green building practices that optimize building framing (per ICC-700 Section 601.2) can have a significant effect on structural performance. When this design accounts for the dominant natural hazards in a given region, optimization can improve structural robustness. For example, optimization in a high-wind region often includes reinforcement of highly stressed connections.

**Special considerations:** The Commentary to Section 601.2 of ICC-700 encourages evaluating advanced framing techniques for wood construction that use less framing material in the building while complying with applicable structural requirements. In some cases, the optimization of framing creates additional design challenges for designers to maintain load paths and other aspects of structural capacity. Unless these techniques are carefully implemented, some aspects of the structure may be compromised. For example, increasing framing spacing from 16 inches on center (o.c.) to 24 inches o.c. garners credits in the ICC-700 rating system, but provides fewer points of connectivity both within walls and between the walls and the roof. In this case, proper installation of each connection is more important than in a more redundant configuration.

## Energy Efficiency

**Beneficial interactions:** Green building practices that improve energy efficiency by using thermal mass can also increase resistance to certain natural hazards. For example, the use of properly detailed concrete or masonry walls can improve resistance to windborne debris in high-wind events.

**Special considerations:** Increasing thermal mass increases the loads imparted on a building in an earthquake. The use of heavier walls increases bracing required to withstand increased earthquake loads. Additionally, energy efficiency decisions that reduce the number or effectiveness of framing connectivity (due to increased framing spacing [see previous example under Resource Efficiency] or wider spaces between structural framing and sheathing or siding) require special attention to detailing. For example, thick exterior insulating sheathing in a high-wind region may require non-standard attachment and flashing to maintain resistance to wind suction and wind-driven rain intrusion into wall cavities.

## Operation, Maintenance, and Building Owner Education

**Beneficial interactions:** ICC-700 provides credit for communicating important building operation and maintenance information to the homeowner. This information can help the homeowner to maintain critical areas in the exterior building envelope, thus minimizing long-term water intrusion and associated building degradation. These simple steps will, in the long run, lead to improved wind and seismic resistance for well-maintained buildings.

## 2.2 Green Building Rating Systems and the Building Codes

Green building rating systems assume implementation of green building practices that are in full compliance with applicable building codes. ICC-700 specifically states this requirement as follows:

**“101.3 Intent.** ... This Standard is not intended to abridge safety, health, or environmental requirements contained in other applicable laws, codes, or ordinances.”

The ICC-700 statement of intent clarifies that green building practices are implemented *in addition* to other requirements of the building code. This process is assumed to provide acceptable building performance in design level natural hazard events. In some regions in the U.S., detailed local review of residential plans is routine. In these areas, building designers will typically apply residential building code provisions to new green building practices, thus meeting the intent of ICC-700. In other regions of the U.S., the latest building code might not be adopted for residential construction and there might be limited structural plan review or inspection.

A fundamental reason for developing this document is to focus the attention of a designer, builder, or homeowner who chooses to modify an existing design (or an existing building) by adding one or more green building features in an effort to improve a building’s sustainability. The primary message is to consider the effect of the modification on other aspects of the building’s performance. The effect of the modification on natural hazard resistance should not be assumed to be accounted for by local building department or building designer review or inspection.



# Sustainable Building Design



The concepts of sustainability and green buildings are defined in a variety of ways, often depending on the particular organization addressing the topic. Consensus based definitions for sustainability and green building have been adopted within both national and international standards development organizations. The term sustainability has been defined as:

**Sustainability** “The maintenance of the ecosystem components and functions for future generations” (American Society for Testing and Materials [ASTM] E 2432)

**Sustainable development** “Development that meets the needs of the present without compromising the ability of future generations to meet their own needs” (ASTM E 2432)

When sustainability focuses specifically on buildings, the term “green building” is often used and has been defined as:

**Green building** “A holistic approach to design, construction, and demolition that minimizes the building’s impact on the environment, the occupants, and the community” (CALGreen, 2010)

**Green building** “A building that meets the specified building performance requirements while minimizing disturbance to and improving the functioning of local, regional, and global ecosystems, both during and after its construction and specified service life” (ASTM E 2432)

As used in today’s green building rating systems, the concepts of sustainability and green building are generally limited to specifically defined attributes. For instance, although the definitions of both sustainability and green building include implicit consideration of building longevity, building

longevity is not explicitly included in the definitions for either concept. Further, the implementation of individual green building practices is often characterized by a practice-by-practice approach (for example, a focus solely on energy efficiency) or a focus on material use in terms of a single attribute, such as recycled content.

Broader considerations for residential building construction—including life-safety protection and limiting property damage during natural hazard events—are assumed to be adequately addressed by building code requirements and are generally not addressed in today’s green building rating systems. Even broader environmental implications, such as global warming effects, ozone depletion, and the release of toxins to air, land, and water, are often only indirectly addressed.

As discussed in Section 2, the IgCC will further clarify what Section 101.3 of ICC-700 already requires—that green building practices must be implemented in a coordinated manner that considers a broad range of other performance requirements. The concepts in this document are intended to provoke discussion to connect green building rating systems with a broader definition of sustainable building design that includes building longevity and natural hazard resistance. The National Institute of Building Sciences (NIBS) Whole Building Design Guide (WBDG) program states that, “While the definition of sustainable design is constantly changing, six fundamental principles persist” (NIBS, 2010). Those principles correspond directly with the six green building categories in ICC-700 shown in Figure 2. The WBDG expands the discussion by identifying two related issues, building resiliency and building adaptability, as follows:

**“Building resiliency** is the capacity of a building to continue to function and operate under extreme conditions, such as (but not limited to) extreme temperatures, sea level rise, natural disasters, etc. As the built environment faces the impending effects of global climate change, building owners, designers, and builders can design facilities to optimize building resiliency.”

**“Building adaptability** is the capacity of a building to be used for multiple uses and in multiple ways over the life of the building. For example, designing a building with movable walls/partitions allow for different users to change the space. Additionally, using sustainable design allows for a building to adapt to different environments and conditions.”

In this context, building resiliency is closely aligned with natural hazard resistance. The additional concept of building adaptability is more relevant in nonresidential structures and will not be addressed further in this document. On this basis, a broad definition that includes both green building practices and hazard resistance concepts could be:

**Sustainable building design** Building design that addresses fundamental sustainability principles by optimizing the use of land, materials, energy, and water for human occupancy and ecosystem health while considering the ability of the building to resist natural hazards.

### 3.1 Decision Process for Sustainable Building Design

The decision process for implementing a new green building practice must consider several factors based on the specific technique and its intended function in accordance with minimum requirements of the building code. Figure 3 is a flowchart of a process to evaluate the interaction of green building products and practices with natural hazard resistance. Although the basic approach of the flowchart can be applied to any new building technique that could affect the integrity of the building structure, it is intended to be specific to green buildings.

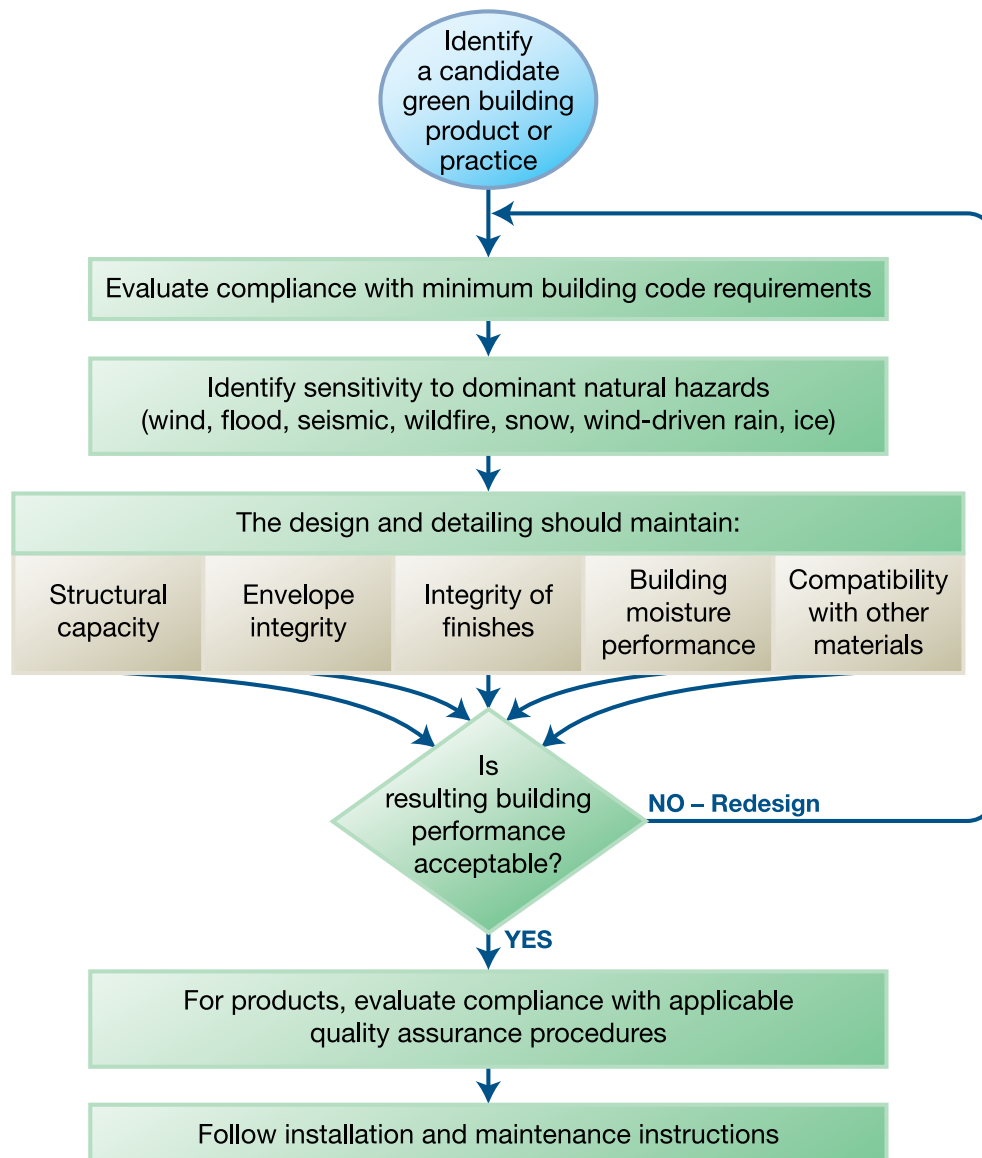

**Figure 3: Hazard Resistance Evaluation Process for Green Building Practices**

It is important for builders and homeowners to remember that some decisions that add green features to a residence may affect the structural performance or natural hazard resistance of the building. These interactions are not always readily apparent (refer to Sections 4 and 5 for specific examples).

Another important factor in successfully implementing a green building practice is the availability of detailed manufacturer's installation instructions, maintenance procedures, and contractor adherence to minimum requirements and product use limitations described in the manufacturer's instructions and product literature. History has shown that for a broad range of building products and practices (not specific to green building) failure to follow manufacturer instructions and maintenance procedures has been demonstrated to result in failures in high-wind events.

### MITIGATION ASSESSMENT TEAMS

Federal Emergency Management Agency (FEMA) has deployed Mitigation Assessment Teams (MATs) after major natural disasters for the past 25 years to collect data and present findings detailing how and why buildings have failed from natural hazards. MAT reports have historically found that construction often does not meet the level of performance targeted by model building codes. For instance, there was widespread damage to residences from Hurricane Ike even though wind speeds were less than the mapped design level wind speeds. FEMA P-757, *Hurricane Ike in Texas and Louisiana* (FEMA, 2009), reports that residential buildings without adequate elevation, proper construction, and proper foundation selection were found to have widespread failures. Successful building design and construction practices are detailed in Chapter 9 of FEMA 549, *Hurricane Katrina in the Gulf Coast* (FEMA, 2006), which describes building design and construction practices that can minimize damage even in an extreme event such as Hurricane Katrina.

## 3.2 Added Benefits of Sustainable Building Design

Designing buildings so that they both resist natural hazards and provide environmental benefits has distinct advantages to homeowners, their neighbors, and society in general. For example, every home that survives a hurricane:

- Provides post-disaster shelter for the home's occupants
- Minimizes windborne debris to downwind homes
- Removes the need for one additional temporary housing structure
- Provides post-disaster sustainability benefits (less material to landfill, less new material needed for reconstruction)

If a home includes additional features, such as zero energy use or other self-sufficiency attributes, it can provide "passive survivability" as well. Passive survivability is the capability of a building to provide adequate shelter for its occupants to survive within the building for several post-disaster days without reliance on outside infrastructure. A checklist of specific design techniques that improve the passive survivability characteristics of a building is available (Environmental Building News, 2006). Passive survivability is also discussed on the NIBS WBDG Web site (NIBS, 2010).

# Sustainability and Natural Hazards



**M**ost common green building practices provide sustainability advantages with little or no effect on structural performance or durability of the building. Other practices can affect the structural performance, sometimes in subtle ways. Still other practices can significantly change the structure's response and require reevaluation of the structural design or detailing to retain the building's integrity under extreme events. A summary description of green building practice interactions with seismic, wind, flood and wildfire natural hazards is provided below, followed by a matrix (Table 1) showing specific green practices that can affect natural hazard resistance.

## 4.1 Seismic Hazard

Typical light-frame residential buildings resist seismic forces through a system of horizontal diaphragms and vertical shear walls. The individual components rely on continuity of perimeter framing, inter-component connections, and anchorage to an adequate foundation to resist these forces. Green building practices that increase the weight of the structure will increase the seismic forces. Practices that interrupt the continuity of perimeter framing members, reduce the strength of the members, or reduce the strength of anchorages and inter-component connections can decrease the seismic resistance of the building. These load path and detailing issues should be addressed by the building designer when applying building code provisions related to seismic design.

## 4.2 Wind Hazard

Many high-wind events are characterized by a combination of wind and rain. Even minor breaches in the building envelope can result in significant water intrusion and economic loss. Light-frame buildings require roof-to-wall connections capable of resisting wind forces. Many portions of a building experience high suction forces in a high-wind event that can lead to sheathing or siding “blow off.” As with resistance to seismic forces, buildings resist lateral wind forces through a system of horizontal diaphragms and vertical shear walls interconnecting building elements into a continuous load path that is critical for successful performance. Green building practices that decrease the redundancy of framing and therefore decrease surfaces for connection between sheathing and framing elements can potentially increase the likelihood of localized connection failures. Practices that increase the building’s wind profile will increase the wind forces experienced by the building. Practices that attach equipment or vegetation to exterior surfaces have the potential to increase windborne debris. These load path and detailing issues should be addressed by the building designer when applying building code provisions related to high-wind design.

## 4.3 Flood Hazard

The only flood-related design consideration addressed in this document is building elevation. Green building practices that encourage reductions in framing materials can also be interpreted to encourage building to code-minimum elevations. This practice can increase the likelihood of flood damage when compared to elevating a residence to greater than building code minimums.

## 4.4 Wildfire Hazard

Green building practices that encourage vegetation for shading and wildlife corridors in the defensible space surrounding the building have the potential to make the building more vulnerable to damage from the spread of fire. The concept of defensible space is typically addressed explicitly by local jurisdictions in regions subject to urban-wildland interface codes. The properties of materials used on the building envelope and their layout also greatly influence the performance of a building in a wildfire event.











## 4.5 Green Building Practice Natural Hazard Sensitivity Matrix

Table 1 (Green Building Practice Natural Hazard Sensitivity Matrix) highlights the potential interactions, both positive and negative, between specific green building practices and one or more natural hazards (wind, seismic, flood, and wildfire). Each row entry includes a brief descriptor of the green building practice, a graphical representation of that practice, a characterization of the interaction with each natural hazard, and a summary explanation of the potential interaction along with suggested techniques to resolve the issue. “Interaction” means that the specific green

building practice has the potential to influence resistance to the hazard specified. The summary explanation of the potential interaction or alternative techniques consists of general statements intended to encourage thought and further consideration of improved techniques of design, detailing, and/or installation.

Example green building practices shown in Table 1 are applicable to comparable provisions in LEED for Homes.



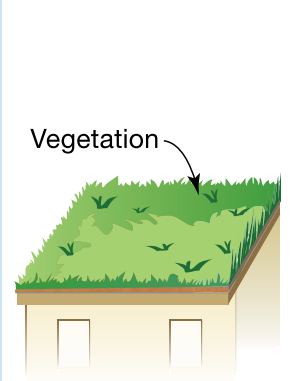



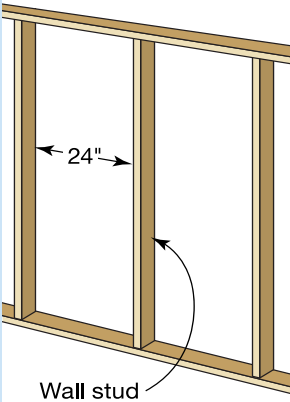

**Table 1: Green Building Practice Natural Hazard Sensitivity Matrix**

ICC-700 Section	Description of Green Building Practice	Graphical Depiction	Natural Hazards				Explanation of Relationship
			Seismic	Flood	Wind	Wildfire	
<b>Lot Design, Preparation, and Development</b>							
501.1 (1)	<b>Lot:</b> An infill lot—vacant or underutilized land with pre-existing utilities—is selected.	 Infill lot	NA		NA		This credit incentivizes building on vacant or unutilized land that has at least some existing utilities on the property. <b>Flood:</b> Infill development within flood hazard areas increases flood risks. Check items such as foundation type, elevation, and materials for compliance with flood-resistant construction practices. <b>Wildfire:</b> Maintain perimeter protections against wildfires.
503.2	<b>Slope disturbance:</b> All or a percentage of development on steep slopes is avoided.						Development away from steep slopes reduces risks from seismic, wind, wildfire, and flood hazards.
	<b>Slope disturbance:</b> Hydrological/soil stability study for steep slopes is completed and used.				NA	NA	Consideration of hazards associated with steep slopes and their hydrological/soil stability will identify potential slope sliding issues due to an earthquake or potential for flooding and erosion damage. The study can recommend appropriate siting or mitigation techniques.

**NOTE:**

 indicates relationship between the green building practice and the given natural hazard that should be considered. “NA” indicates little or no significant relationship between the green building practice and the given natural hazard.

**Table 1: Green Building Practice Natural Hazard Sensitivity Matrix (continued)**











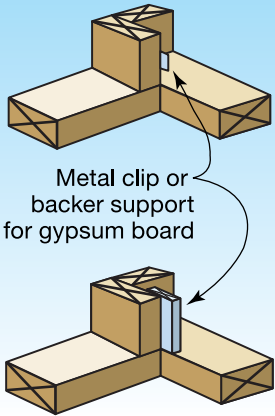

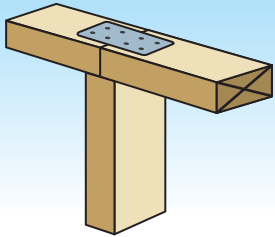
ICC-700 Section	Description of Green Building Practice	Graphical Depiction	Natural Hazards				Explanation of Relationship
			Seismic	Flood	Wind	Wildfire	
<b>Lot Design, Preparation, and Development</b>							
503.4 (3)	<b>Stormwater management:</b> Impervious surfaces that do not absorb water are minimized, and permeable surfaces are used.		NA		NA	NA	A greater amount of pervious surface improves stormwater management for small-scale flooding events at the site. Pervious surfaces can: <ul style="list-style-type: none"> <li>• Minimize flooding</li> <li>• Protect groundwater supplies</li> <li>• Reduce contamination issues from surface water</li> </ul>
503.4 (4)	<b>Stormwater management:</b> A roof that is partially or completely covered with vegetation (a green roof) is installed on the building.			NA			Additional dead load, potential debris, and durability factors create additional considerations for green roofs. For dead load considerations, the structure should be evaluated for its ability to resist the added roof weight. The roof waterproofing system should be evaluated for its ability to resist leaks, root penetration, and moisture related problems. <p><b>Seismic:</b> Evaluate structure’s ability to resist increased seismic forces from increased roof weight.</p> <p><b>Wind:</b> Evaluate system’s ability to minimize potential for the roof surface to become windborne debris.</p> <p><b>Wildfire:</b> Vegetation on a building can increase the building’s risk from wildfires.</p>
<b>Resource Efficiency (material usage, advanced framing techniques)</b>							
601.2	<b>Increased framing spacing:</b> Increase wood or steel stud spacing to reduce material usage and increase insulation. May include increased spacing of floor and roof framing.			NA		NA	Using 24-inch stud spacing (as opposed to 16-inch stud spacing) results in each stud carrying a greater load, reduction in number of studs for connections, and increased spans for sheathing and other finish materials. <p><b>Seismic and Wind:</b> Check the design capacity of the studs, stud attachment to plates, fastener schedule, sheathing thickness, and load path for out-of-plane wind and seismic loads. Increasing stud spacing may affect the performance of certain exterior finishes under out-of-plane wind loads. More fasteners or thicker finish materials may be required.</p>

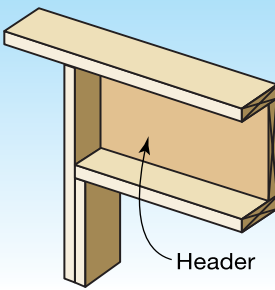
**NOTE:**

 indicates relationship between the green building practice and the given natural hazard that should be considered. “NA” indicates little or no significant relationship between the green building practice and the given natural hazard.



**Table 1: Green Building Practice Natural Hazard Sensitivity Matrix (continued)**

ICC-700 Section	Description of Green Building Practice	Graphical Depiction	Natural Hazards				Explanation of Relationship
			Seismic	Flood	Wind	Wildfire	
601.2	<b>Two-stud corner:</b> Frame building corners with two studs to reduce material usage and increase insulation (wood detail shown, also applicable to steel).	 <p>Metal clip or backer support for gypsum board</p>		NA		NA	Evaluate design of two-stud corner (as opposed to the traditional method of three studs) for ability to resist gravity, uplift, and overturning loads. <b>Seismic and Wind:</b> Check details for interconnection of wall studs. Check hold-down details for shear wall overturning as it may be based on three-stud corner detail instead of two-stud corner.
	<b>Single top plate:</b> Frame connections at top of wall studs using single wood top plate.			NA		NA	A single top plate (as opposed to the traditional double top plate) has reduced ability to transfer gravity loads and is not effective in acting as a diaphragm chord unless properly spliced. Check the design of the top plate for loads from the framing above. <b>Seismic and Wind:</b> Check splices for continuity.
	<b>Right-sized header:</b> Design wood or steel framing for single member header optimally sized for loads.	 <p>Header</p>		NA		NA	A single member header (as opposed to the traditional two-member header) has reduced ability to transfer gravity loads and out-of-plane wind loads if not properly designed and interconnected. Check the design of the header for loads from the framing above. <b>Seismic and Wind:</b> Check connection of header to framing for connections to transfer out-of-plane wind or seismic loads.
<b>Resource Efficiency (other)</b>							
604.1	<b>Recycled content:</b> Building materials with recycled content are used for minor and/or major components of the building.						Evaluate the product to ensure that it retains the appropriate properties for the application, as well as for compatibility with the other building materials. Evaluate materials for any VOCs toxic to human health.

**NOTE:**

 indicates relationship between the green building practice and the given natural hazard that should be considered.  
 “NA” indicates little or no significant relationship between the green building practice and the given natural hazard.



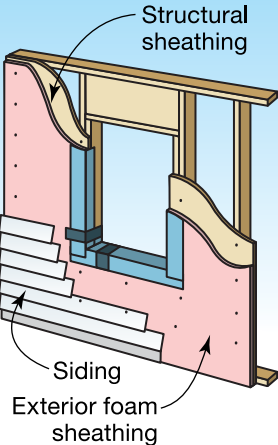
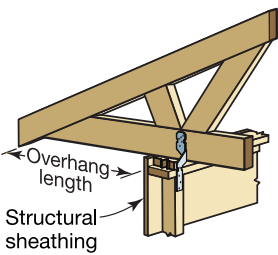

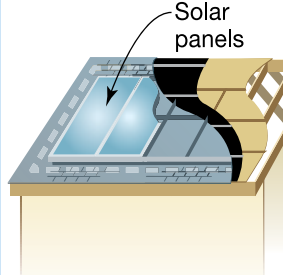



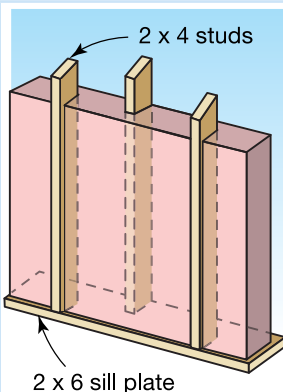

**Table 1: Green Building Practice Natural Hazard Sensitivity Matrix (continued)**

ICC-700 Section	Description of Green Building Practice	Graphical Depiction	Natural Hazards				Explanation of Relationship
			Seismic	Flood	Wind	Wildfire	
<b>Energy Efficiency</b>							
703.1	<p><b>Building envelope:</b> Increase exterior insulation on exterior walls; often accomplished by use of foam sheathing.</p>	 <p>Structural sheathing Siding Exterior foam sheathing</p>	⚠	NA	⚠	⚠	<p>Designing for increased insulation can change the structural and fire properties of the wall.  <b>Seismic and Wind:</b> Check for adequate structural strength and connections to resist in-plane and out-of-plane forces as applicable. Check flashing/installation details to address potential for water intrusion.  <b>Wildfire:</b> Check siding and sheathing used on exterior walls to ensure that they have been approved for use in wildfire-prone areas.</p>
704.3.1.1 (7)	<p><b>Solar space heating and cooling:</b> Overhangs, adjustable canopies, awnings, or other coverings to provide shading over glazing.</p>	 <p>Overhang length Structural sheathing</p>	⚠	NA	⚠	⚠	<p>Extended overhangs require an adequate load path and proper connections. Check headers and other framing members supporting the roof for adequate size for the increased loads due to the roof itself as well as snow load.  <b>Seismic:</b> Check for adequate attachment of the roof diaphragm to the wall below, as well as the seismic load path for increased forces due to the weight of the roof and potentially increased snow loads.  <b>Wind:</b> Check roof uplift connections, soffit details, shear transfer, and sizing of roof framing for added loads.  <b>Wildfire:</b> Check requirements for protection of soffit vents, fire rating of soffit sheathing and coverings, and other requirements for protecting the underside of the overhang from blown embers.</p>

**NOTE:**

⚠ indicates relationship between the green building practice and the given natural hazard that should be considered.  
 "NA" indicates little or no significant relationship between the green building practice and the given natural hazard.

Table 1: Green Building Practice Natural Hazard Sensitivity Matrix (continued)

ICC-700 Section	Description of Green Building Practice	Graphical Depiction	Natural Hazards				Explanation of Relationship
			Seismic	Flood	Wind	Wildfire	
704.3.1.3 (1)	<b>Solar space heating and cooling:</b> Vegetative or other forms of shading around the building perimeter.		NA	NA	 		<p><b>Wind:</b> Trellises, awnings, covered porches, and other forms of shading that are not designed to resist high-wind forces can become windborne debris and damage the building. Check connections of any structures attached to the building or anchored nearby.</p> <p><b>Wildfire:</b> Vegetative and other flammable shading can present a wildfire hazard around homes in wildfire-prone areas. Ensure that vegetation separation is adequate in wildfire regions.</p>
704.3.3	<b>Additional renewable energy options:</b> Roof-mounted solar photovoltaic panels (not applicable to building-integrated photovoltaic systems).			NA	 		<p>Adding a rooftop solar panel system can add dead loads and create durability issues. Check the framing for adequacy to support the added weight of these systems and determine if the potential for water intrusion at the connections is addressed. The designer should also:</p> <p><b>Seismic and Wind:</b> Check framing and connections for ability to maintain load path and resist applied forces.</p> <p><b>Wildfire:</b> Check that the flame spread rating of the solar panel system meets applicable code requirements.</p>
703.1.1	<b>Insulation and air sealing:</b> Stagger studs within a wall for additional insulation and thermal efficiency.			NA		NA	<p>A staggered stud wall provides designers with improved sound transmission performance. It has also been suggested as a technique to provide greater cavity space for insulation while effectively eliminating thermal bridging.</p> <p><b>Seismic and Wind:</b> Check structural interactions between wall surfaces as well as the load path for gravity, uplift, and lateral loads. Alternative tested assemblies are available that provide improved sound transmission and thermal breaks.</p>

**NOTE:**

 indicates relationship between the green building practice and the given natural hazard that should be considered. "NA" indicates little or no significant relationship between the green building practice and the given natural hazard.



# Examples of Green Building Practices and Natural Hazard Resistance



**I**t is important to evaluate whether a green building practice will affect a building's integrity or durability in a way that is not obvious or considered. The following examples demonstrate how some green practices can affect a building's resistance to natural hazards. The examples are purposely one-dimensional and simplistic for two reasons. First, the examples focus on a single performance aspect to illustrate a specific potential design consideration or oversight. Second, to quantify the consequences of applying a green building practice without full consideration of natural hazard resistance, the examples use engineering terms or LCA terms that may be unfamiliar to some readers. LCA is a methodology for assessing the environmental performance of a product, an assembly, or an entire building over its full life cycle, often referred to as cradle-to-grave or cradle-to-cradle analysis (refer to Appendix A for more information).

The first example lists the considerations that accompany a homeowner's decision to improve energy efficiency by installing rooftop solar panels. The second example compares the minimal changes needed to modify a building design to add solar shading (via extended roof overhangs) with the benefits (quantified in LCA terms) of natural hazard resistance. The third example computes the financial benefits of raising a home several feet above base flood elevation (BFE) even though more material would be required.

## 5.1 Example 1: Rooftop Solar Photo-Voltaic Panels

Example 1 is intended to demonstrate the steps required when adding rooftop solar panels to an existing building to account for hazard resistance. Depending on the mounting detailing, the solar panel system could add significant uplift loads to the roof and possibly trigger localized structural failure. To retain structural capacity of the roof under high-wind loads, the additional loads of the solar panel system must be properly accounted for in the design. The loads must be transferred to the roof framing and the complete load path must be evaluated. Although this example focuses on solar photovoltaic panels, the structural considerations apply equally to solar hot water panel systems.

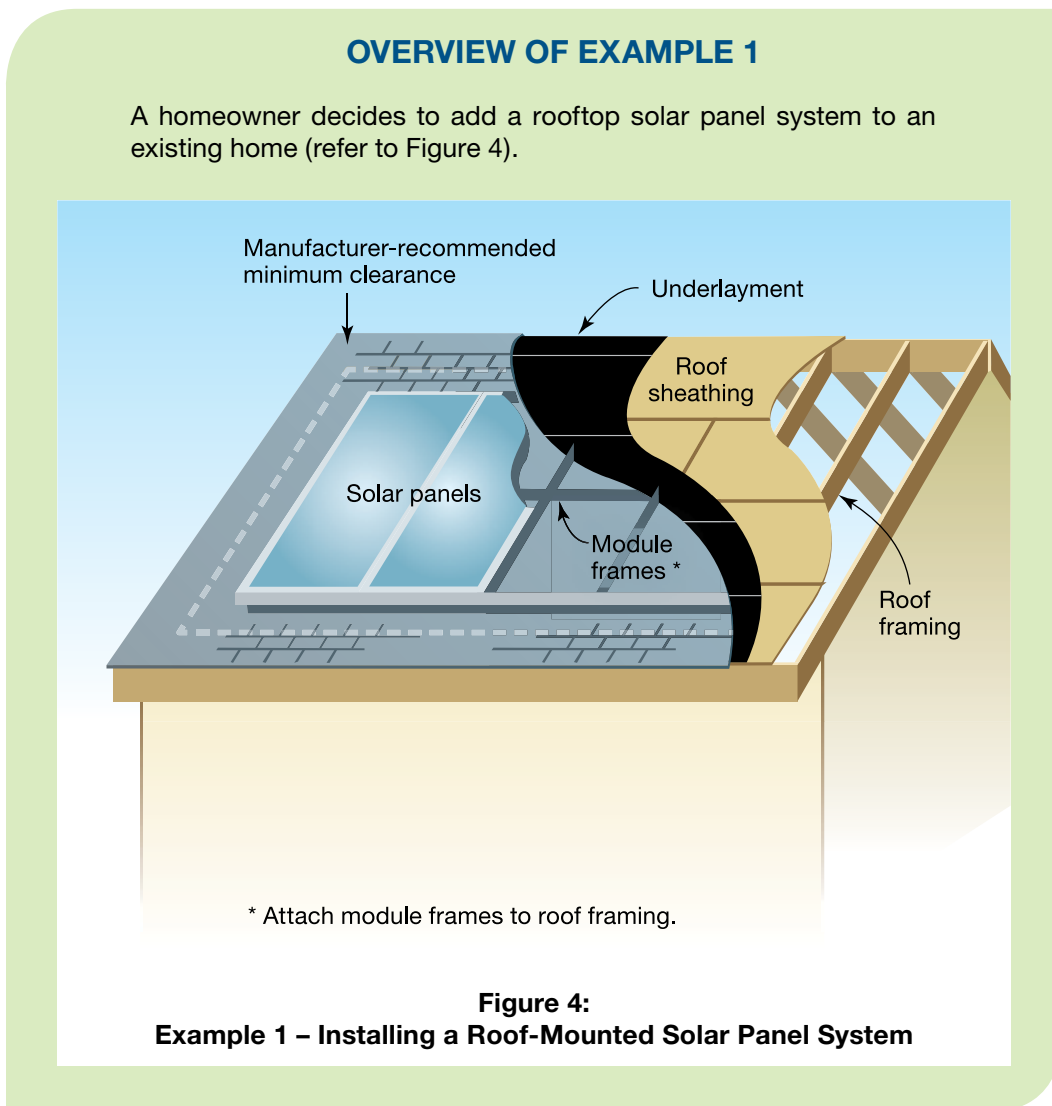

## Discussion of Example 1

Numerous additional design and detailing considerations may be needed to properly implement the solar panel system, including:

- Reviewing applicable requirements of the local building code including, but not limited to, requirements for:
  - › wind and seismic (e.g., attachments must be properly designed and detailed to resist wind and seismic forces)
  - › wildfire (e.g., fire class rating of the solar panel system must meet local code requirements)
  - › installation of electrical wiring, including provisions for drilling of holes for wiring in structural roof framing members
- Following manufacturer's installation instructions to determine:
  - › allowable wind pressure rating (the allowable wind pressure rating should exceed the design wind pressure rating for the wind speed zone, height, and exposure of the roof)
  - › applicable conditions for use of the solar panels (including location of the roof relative to coastal, salt water, or other corrosive locations and roof conditions such as roof covering type and age, roof pitch, and framing system)
  - › applicable requirements for use of special membranes and sealants and/or use of flashing to prevent moisture intrusion
  - › methods recommended for maintaining and cleaning the solar panel system
- Where approved prescriptive solutions are not available, consulting a professional engineer where assistance is needed to determine:
  - › adequacy of the roof framing and attachment method for resistance to wind and seismic forces
  - › presence of a complete load path through the roof, into the wall framing, and to the foundation
  - › the ability of the roof and supporting framing to safely carry the added weight of the solar panel system
- Checking with the local utility for any local requirements related to on-site electrical power generation.
- Determining what power generation is achievable and matching that to the more important electrical loads. It is often not practical to power **all** electrical loads in a home (e.g., ovens, stoves, and air conditioning units), but loads for lights, fuel-fired heating units, refrigerators, freezers, and well pumps can typically be powered. Sizing the system to supply these loads will help a homeowner respond to natural hazard events (such as ice storms, hurricanes, or floods) that can interrupt utility power for extended periods of time.

## 5.2 Example 2: Solar Shading Using Roof Overhangs

Example 2 is intended to provide an idealized illustration of the effect of increased roof overhang length on wind uplift forces. The illustration demonstrates that this green building practice can be implemented in a manner that retains the building's integrity under high-wind loads at little additional cost. The consequence of **not** accounting for the increased uplift forces is presented in LCA terms.

### OVERVIEW OF EXAMPLE 2

A building designer is modifying a set of house plans in order to gain points to qualify for the next rating system level. The designer decides to extend the overhangs of an existing home design to provide solar shading. The initial design with an overhang length of 6 inches was code-compliant and prescriptive solutions for anchoring to supporting walls were within the scope of the IRC (ICC, 2009). The designer specifies a larger overhang length of 3 feet, 3 inches (see Figure 5).

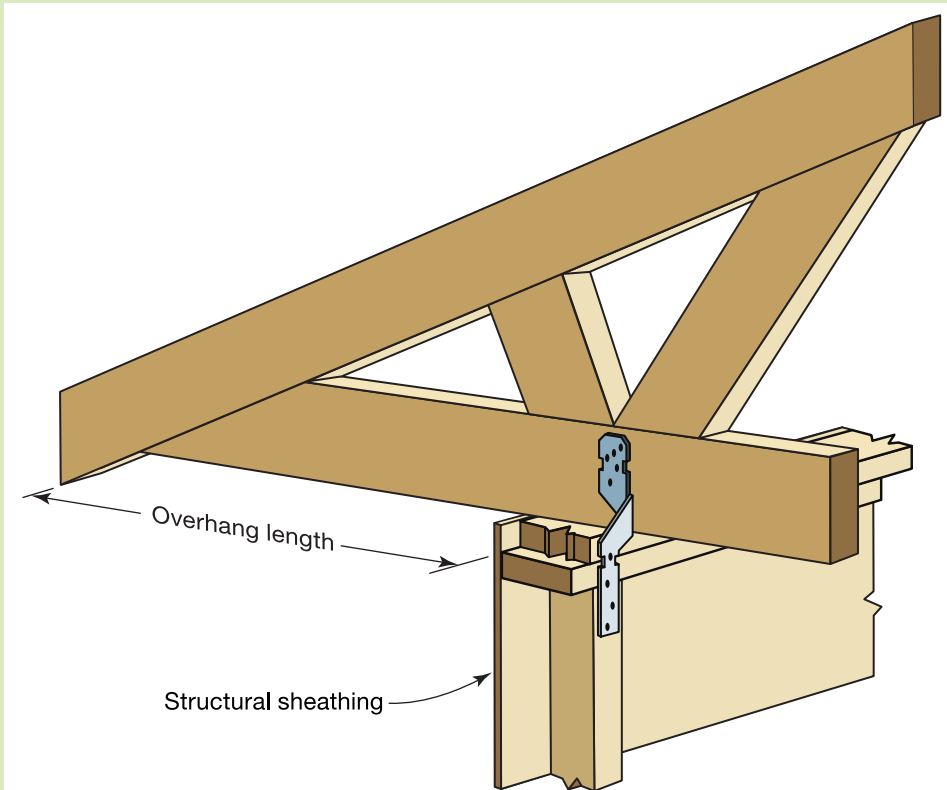

**Figure 5:**  
**Example 2 – Large Roof Overhang for Solar Shading**



## Discussion of Example 2

This example quantifies only the interaction between the increased overhang length and the associated increased uplift loads on the roof-to-wall connection. The sustainability benefits of the added solar shading are dependent upon the building’s location, orientation, and configuration and are outside the scope of this discussion. As shown in Table 2, when compared with the baseline roof uplift connector requirement (the originally designed 6-inch overhang), the increased overhang length results in nearly 40 percent higher wind uplift forces. While these higher loads are significant, they are within a range that can be addressed by reinforcing the roof-to-wall connection. For this specific design case, no additional load path redesign is required. Soffit reinforcing may also be required to address wind-driven rain intrusion, but a detailed discussion of that requirement is beyond the scope of this example.

**Table 2: Example 2 – Details for Adding Solar Shading Overhang**

Design Feature	Case A: Benchmark building	Case B: Add solar shading and code-compliant structural reinforcement for wind uplift
Building size	Single story, 41 feet wide x 68 feet long (roof truss span varies)	
Wind zone	Exposure C, 110 mph design wind speed per American Society of Civil Engineers (ASCE) 7-10	
Roof overhang	6 inches	3 feet, 3 inches
Roof uplift connector force*	283 pounds	410 pounds
Uplift connector**	Proprietary metal strap attached to stud and rafter with (8) 10d common wire nails per strap	Proprietary metal strap attached to stud and rafter with (12) 10d common wire nails per strap

\* Based on 24-foot truss span.

\*\* Total additional steel required < 3 pounds.

## Life Cycle Assessment Implications

The concept of LCA can be applied to residential construction by evaluating assemblies (e.g., roof assemblies) or whole buildings to quantify the relative environmental impacts of loss of the assembly or the building as a result of a natural disaster event versus the environmental costs of improving the initial construction to avoid such losses. The goal of LCA is to cast the net wide and capture all of the relevant effects associated with a product or process over its full life cycle. Section 609 of ICC-700 provides incentives for LCA.

From an LCA perspective, the environmental cost of adding less than 3 pounds of steel in the reinforced connections is negligible. However, it is interesting to hypothesize what would happen if these connections were not reinforced when the length of the overhangs was increased. While such a scenario is not code-compliant, such oversights are possible especially in regions where code enforcement is less stringent or where the building designer is not aware of the design modification.

In this hypothetical scenario, reinforcing the roof-to-wall connection increases the likelihood that the building will withstand high-wind events (such as hurricanes or tornadoes). In LCA terminology, attention to this detail has sustainability benefits that are called “avoided environmental impacts.” In other words, LCA can quantify the environmental benefits of avoiding a premature failure in which the building might experience partial (loss of roof) or complete (loss of entire building) structural failure.

The avoided environmental impacts illustrated in Example 2 are computed by standard LCA techniques. The results are provided for two scenarios: one in which the roof must be replaced and a second in which (possibly due to extensive water damage or broader structural failure) the entire building must be replaced. Figure 6 illustrates the avoided environmental impacts for two of the primary indicators—primary energy consumption and global warming potential. The results for all six primary LCA indicators related to Example 2 are summarized in Appendix A.

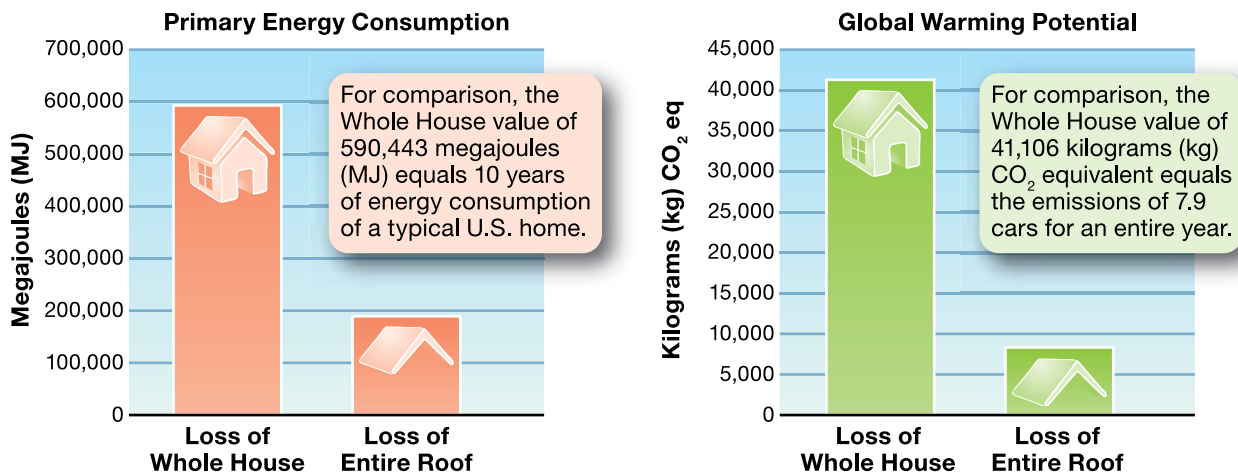

**Figure 6:**  
**Example 2 – Avoided Environmental Impacts for Two LCA Indicators**

## 5.3 Example 3: Elevating a Structure Above the Base Flood Elevation – Material Minimization Considerations

Example 3 is intended to illustrate, in an idealized example, the interaction of framing optimization with flood damage risk. It shows that, in some cases, using more framing material rather than less is the optimal decision. For this example, insurance premium amounts are used as the indicator of flood damage risk.

### OVERVIEW OF EXAMPLE 3

An environmentally minded builder wishes to minimize foundation material in a specific home design (see Figures 7 and 8). The home will be located in a coastal flood zone. The builder contemplates whether to establish the building elevation at the minimum code-prescribed elevation or whether it might be advantageous to raise it above that level.

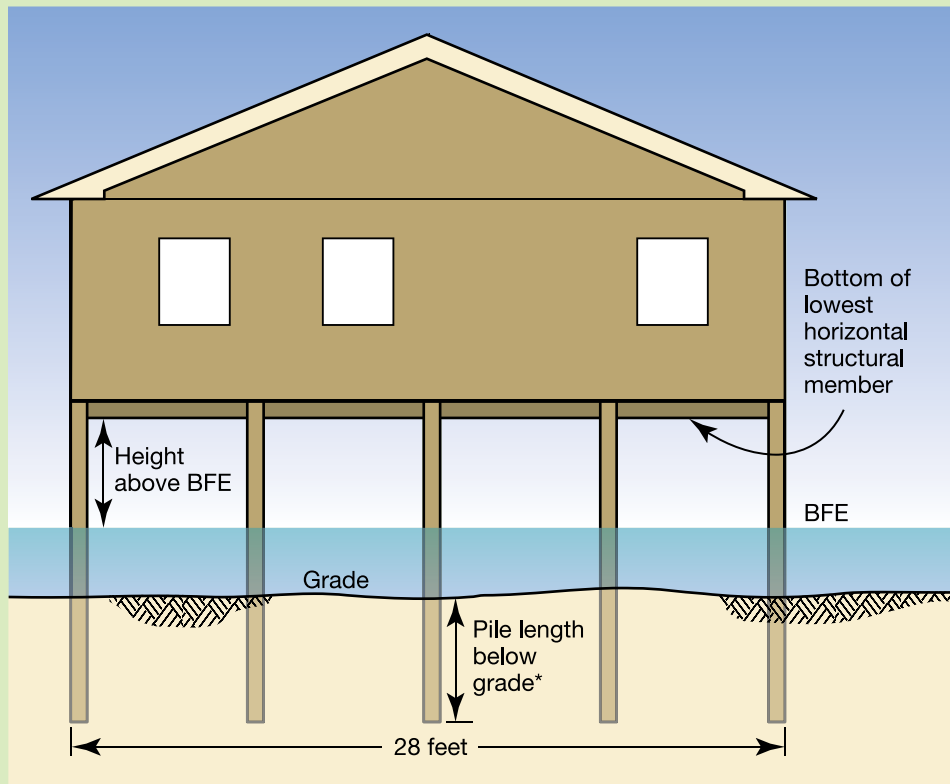

\*Pile length below grade is not to scale.

**Figure 7:**  
**Example 3 – House Elevated on Piles in Coastal Flood Zone A**

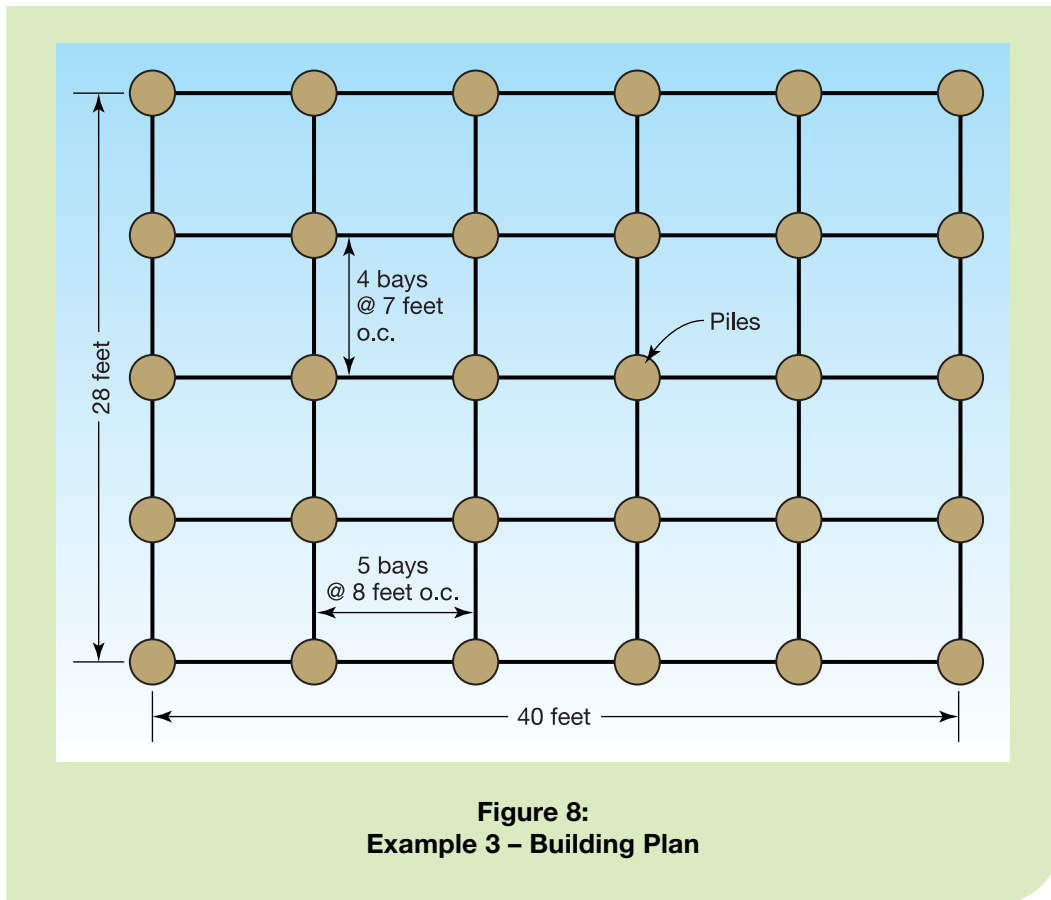

**Figure 8:**  
**Example 3 - Building Plan**

### Discussion of Example 3

There are numerous design and detailing considerations associated with elevating a building to various heights. These include, but are not limited to:

- Consideration of increased dead load for foundation design and calculation of seismic forces
- Consideration of increased pile length when sizing the pile to resist wind, seismic, gravity, and flood forces
- Consideration of increased forces on the building from wind

This example shows the differences in flood insurance premiums (which correlate to probabilities of damage and/or building failure) versus the material costs of increasing the building elevation from the BFE in Case A to 4 feet above BFE in Case B (Table 3). The pile diameter, along with the height, was adjusted from Case A to Case B assuming equal moment demand/capacity ratio of the piles between the two cases. As shown in Table 3, the material and construction cost of increasing the elevation by 4 feet is \$5,025.

**Table 3: Details of Buildings for Example 3 – Building Elevation in Flood Zone**

Design Feature	Case A. Benchmark building	Case B. Increase elevation by 4 feet
Building size	Single story: 28 feet x 40 feet / Pile foundation: 30 piles	
Coastal Flood Zone	Coastal Zone A	
Height above BFE	0 feet	4 feet
Top diameter of pile	8 inches	11 inches
Volume of foundation material per pile	4.5 cubic feet	11.2 cubic feet
Weight of foundation material per pile	165.7 pounds	410.2 pounds
Material cost per pile*	\$112.50	\$280.00
Installed cost per pile**	\$262.50	\$430.00
Total foundation cost	\$7,875.00	\$12,900.00
Difference in cost	\$5,025	

\* Assume \$25.00 per cubic foot.

\*\* Assume \$10.00 per driven foot installation cost (15 feet embedment).

## Break-Even Analysis

The annual insurance premium of Case A would be \$1,512, while the annual insurance premium for Case B would be \$526. The difference in cost to elevate the building 4 feet (Case B) is \$5,025, while the annual insurance premium savings for a \$250,000 building (and \$100,000 contents value) is \$986 annually (refer to Table 4). Therefore, homeowners choosing to elevate their home 4 feet above the BFE would break even on their investment in 5.1 years.

This example indicates that the increase in initial material cost is overshadowed over time by the savings (both financial and in terms of avoided environmental impacts) garnered by elevating the building above code-minimum levels.

**Table 4: Sample National Flood Insurance Program Flood Insurance Premiums for Buildings in Zone A and Coastal Zone A**

Floor Elevation above BFE	Reduction in Annual Flood Premium	Annual Premium*	Savings
1 foot	44%	\$ 850	\$ 662
2 feet	59%	\$ 616	\$ 896
3 feet	65%	\$ 526	\$ 986
4 feet	65%	\$ 526	\$ 986

\*Coverage: \$250,000 Building/\$100,000 Contents.

Rates as of October 2009 per <http://www.floodsmart.gov>.



# Appendix A: Sustainability and Life Cycle Assessment

## Overview

International standards related to sustainability often address the topic in terms of three pillars—environmental, social, and economic. As discussed in Section 2.1, there are many factors that can contribute to a specific product or practice being considered as green. Ideally, the full environmental effect of a green practice should be accounted for when addressing the environmental pillar. This can be done through the use of LCA.

Put simply, LCA is a methodology for assessing the environmental performance of a product, an assembly, or an entire building over its full life cycle, often referred to as cradle-to-grave or cradle-to-cradle analysis. Section 609 of ICC-700 provides incentives for LCA. The concept of LCA can be applied to residential construction by evaluating assemblies (e.g., roof assemblies) or whole buildings to quantify the relative environmental impacts of loss of the assembly or the building as a result of a natural disaster event versus the environmental costs of improving the initial construction to avoid such losses.

In LCA, environmental impacts are generally measured in terms of a wide range of potential indicators, such as the following:

- Fossil fuel depletion
- Use of other non-renewable resource
- Water use
- Global warming potential
- Stratospheric ozone depletion
- Ground-level ozone (smog) creation
- Nutrifaction/eutrophication of water bodies
- Acidification and acid deposition (dry and wet)

All of these are measures of the environmental loadings that can result from the manufacture, use, and disposal of a product. The goal of LCA is to cast the net wide and capture all of the relevant effects associated with a product or process over its full life cycle. These indicators do not address the human or ecosystem health effects, which is a much more difficult and uncertain task.

In LCA, the indicators associated with making, transporting, using, and disposing of products are referred to as **embodied effects**, where the word embodied refers to attribution or allocation in an accounting sense. In the building community, the tendency is to refer primarily to embodied *energy*, but there is a wide range of embodied effects, as per the list of indicators. All extractions from the earth and releases to nature are embodied effects. There are also embodied effects associated with producing and transporting energy itself (termed pre-combustion effects).

LCA is already in widespread use around the world, especially for products or systems for which the analytical boundaries are well-defined. For example, the LCA impacts can be reasonably approximated for materials such as wood, steel, and concrete and for consumer goods such as electronic equipment. LCA is also being applied to building assemblies and whole buildings, with specialized calculation tools available in various countries. For example, the ATHENA<sup>®</sup> EcoCalculator for assemblies and the ATHENA<sup>®</sup> Impact Estimator for buildings are tools in widespread use by designers throughout North America (Athena Institute, 2010a, b). The EcoCalculator is directly referenced in the Green Globes (Green Building Initiative, 2010) and LEED rating systems for commercial construction. LCA is also being applied by industry, using LCA-practitioner tools such as SimaPro and GaBi (PE International, 2010 and PRé Consultants, 2010), to better understand and improve environmental performance at the manufacturing level. The U.S. Environmental Protection Agency (EPA) lists these and other LCA tools and resources on its Web site (EPA, 2010).

## Life Cycle Assessment for Example 2 House

A hypothetical house was used to compute LCA parameters to support Example 2 in Section 5.2, the solar shading roof overhang example. LCA indicators were computed for the entire house and separately for the roof only. Details of the house and a summary of LCA indicators are provided below.

**Goal:** Quantify the LCA avoided environmental impact implications of survival versus failure of a building or component. “Loss / Replacement of Whole House” is shown as a worst case scenario. “Loss / Replacement of Roof Only” (complete roof separation from the building) provides an additional point of evaluation.

**Scope:** The analysis is based on building materials (manufacturing, construction, end-of-life transportation) for the Case A scenario, the building as originally designed with 6-inch overhangs. (The difference in LCA indicators when including the longer overhangs and additional nails outlined for the Case B scenario is negligible.) Operating energy for the house is not included in this analysis.



**House Details:**

- Single-story residence on concrete slab floor
- 2,153 square feet (41 feet by 68 feet)
- Conventional wood-framing with engineered wood truss roof
- Stucco exterior wall finish; asphalt shingle roofing

**LCA Indicators:** As shown in Table A1, most of the LCA environmental impacts associated with damage to the whole house and damage to the roof relate to the manufacturing of the materials, which accounts for over 90 percent of each of the indicators.

**Table A1: LCA Indicators for Example 2 House**

Impact Measures	Total	Units	Percent of Total		
			Manufacturing	Construction	End-of-Life Transportation*
<b>Replacement of Whole House</b>					
Primary Energy Consumption	590,442.69	MJ	93.98%	5.11%	0.91%
Weighted Resource Use	171,127.54	kg	99.55%	0.45%	0.00%
Global Warming Potential	41,106.32	kg CO <sub>2</sub> eq	96.93%	3.04%	0.03%
Acidification Potential	17,496.30	moles of H <sup>+</sup> eq	96.93%	3.05%	0.02%
Human Health Respiratory Effects Potential	162.70	kg PM <sub>2.5</sub> eq	99.15%	0.85%	0.00%
Eutrophication Potential	10.30	kg N eq	96.91%	3.06%	0.03%
Ozone Depletion Potential	0.00	kg CFC-11 eq	—	—	—
Smog Potential	123.56	kg NO <sub>x</sub> eq	93.23%	6.71%	0.06%
<b>Replacement of Roof Only</b>					
Primary Energy Consumption	187,633.90	MJ	94.74%	4.91%	0.35%
Weighted Resource Use	36,923.36	kg	98.57%	1.42%	0.00%
Global Warming Potential	7,852.49	kg CO <sub>2</sub> eq	91.99%	8.00%	0.02%
Acidification Potential	3,470.03	moles of H <sup>+</sup> eq	92.76%	7.23%	0.01%
Human Health Respiratory Effects Potential	41.61	kg PM <sub>2.5</sub> eq	97.54%	2.46%	0.00%
Eutrophication Potential	2.17	kg N eq	97.52%	2.46%	0.02%
Ozone Depletion Potential	0.00	kg CFC-11 eq	—	—	—
Smog Potential	21.33	kg NO <sub>x</sub> eq	94.05%	5.91%	0.04%

\* Includes transportation to landfill for materials that are not currently reused or recycled.

Unit abbreviations: kg kilograms  
 kg CO<sub>2</sub> eq kilograms carbon dioxide equivalent  
 kg N eq kilograms nitrogen equivalent  
 kg NO<sub>x</sub> eq kilograms nitrogen oxide equivalent  
 kg PM<sub>2.5</sub> eq kilograms particulate matter (< 2.5µm)  
 kg CFC-11 eq kilograms trichlorofluoromethane equivalent  
 MJ megajoules  
 moles of H<sup>+</sup> eq moles of hydrogen equivalent

**Discussion of LCA Indicators:** Because LCA indicators are displayed in scientific units that are somewhat difficult to put into perspective, it is common to translate these units into so-called “humanized terms” as shown in Figure A1.

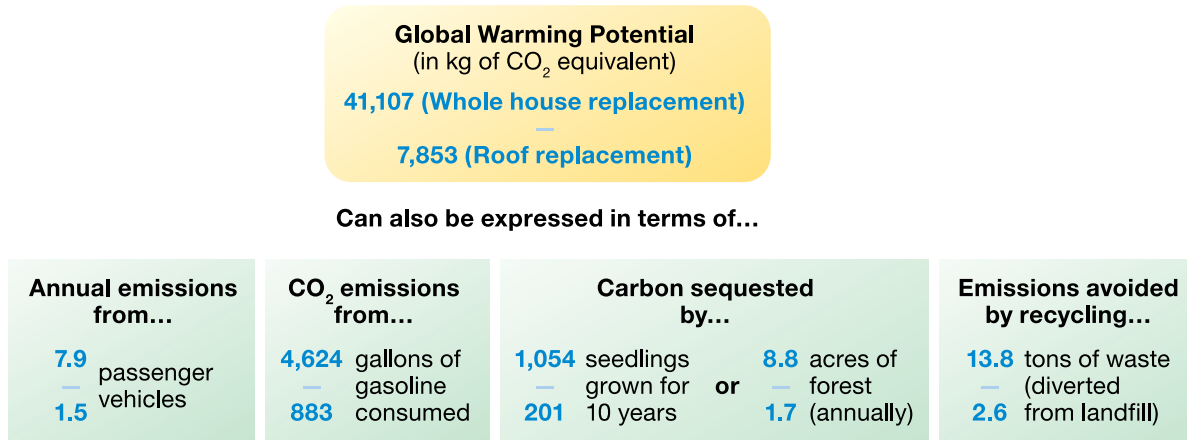

**Figure A1: Humanized Terms for One LCA Indicator for Example 2 House**

# Appendix B: Acronyms

<b>ASCE</b>	American Society of Civil Engineers
<b>ASTM</b>	American Society for Testing and Materials
<b>BFE</b>	base flood elevation
<b>EPA</b>	Environmental Protection Agency
<b>FEMA</b>	Federal Emergency Management Agency
<b>ICC</b>	International Code Council
<b>IgCC</b>	International Green Construction Code
<b>IRC</b>	International Residential Code
<b>LCA</b>	life cycle assessment
<b>LEED</b>	Leadership in Energy and Environmental Design
<b>MAT</b>	Mitigation Assessment Team
<b>NIBS</b>	National Institute of Building Sciences
<b>o.c.</b>	on center
<b>VOC</b>	volatile organic compound
<b>WBDG</b>	Whole Building Design Guide



# Appendix C: References and Resources

## References

American Society of Civil Engineers (2010). *Minimum Design Loads for Buildings and Other Structures*. ASCE 7-10, Washington, D.C.

American Society for Testing and Materials (2005). *Standard Guide for General Principles of Sustainability Relative to Buildings*. ASTM E 2432.

Athena Institute (2010a). Eco-Calculator. <http://www.athenasmi.org/tools/ecoCalculator>.

Athena Institute (2010b). Impact Estimator for Buildings. <http://www.athenasmi.org/tools/impactEstimator>.

Bowyer, Jim L. (2010). *Green Building and Implications for Wood Markets*, Wood Design Focus. Vol. 20, No. 1, pp. 3-7. Forest Products Society, Madison, WI. <http://www.forestprod.org>.

CALGreen (2010). *California Green Building Standards Code*. California Building Standards Commission. <http://www.bsc.ca.gov>.

Environmental Building News (May 1, 2006). <http://www.buildinggreen.com/auth/article.cfm/2006/5/3/Passive-Survivability-A-New-Design-Criterion-for-Buildings/?checklist=1>. Date accessed August 31, 2010.

Environmental Protection Agency (2010). Life Cycle Assessment. <http://www.epa.gov/research/NRMRL/lcaccess/resources.html#Software>.

Federal Emergency Management Agency (FEMA) (2006). *Hurricane Katrina in the Gulf Coast*. FEMA 549.

FEMA (2009). *Hurricane Ike in Texas and Louisiana*. FEMA P-757.

Green Building Initiative. Green Building Assessment Protocol for Commercial Buildings, ANSI/GBI 01-2010. <http://www.thegbi.com>. Date accessed September 2010.

- International Code Council (2010). *International Green Construction Code Public Version 1.0*. <http://www.iccsafe.org>. Date accessed September 2010. Anticipated that final version will be published in 2011.
- National Association of Home Builders (NAHB) (2008a). *National Green Building Standard*. ICC-700. Washington, D.C.
- NAHB (2008b). *National Green Building Standard Commentary*. ICC-700 Commentary. Washington, D.C.
- National Institute of Building Sciences (NIBS) (2010). *Whole Building Design Guide*. <http://www.wbdg.org/design/sustainable.php>. Date accessed July 27, 2010.
- PE International (2010). *GaBi Software Product Sustainability*. <http://www.gabi-software.com>.
- PRé Consultants (2010). *SimaPro LCA Software*. <http://www.pre.nl/simapro>.
- U.S. Green Building Council. *Green Home Guide*. <http://greenhomeguide.com/program/leed-for-homes>. Date accessed September 2010.
- Wilson, A. (2006). *Passive Survivability: A New Design Priority for the 21st Century*. GreenSource Magazine, June 2006. <http://greensource.construction.com/people/0606mag-opinions.asp>.

## Resources

- FEMA (2006). *Homebuilders' Guide to Earthquake-Resistant Design and Construction*. FEMA 232. <http://www.fema.gov/library/viewRecord.do?id=2103>.
- FEMA (2008). *Home Builder's Guide to Construction in Wildfire Zones*. FEMA P-737. <http://www.fema.gov/library/viewRecord.do?id=3646>.
- Scientific Applications International Corporation (SAIC) (2006). *Life Cycle Assessment: Principles and Practice*. Reston, VA. <http://www.epa.gov/nrmrl/lcaccess/pdfs/600r06060.pdf>.
- Unger, N.; P. Beigl; and G. Wassermann (2004). *General Requirements for LCA Software Tools*. <http://www.iemss.org/iemss2004/pdf/infotech/ungegene.pdf>.

Comments/Questions:

This is the first edition of *Natural Hazards and Sustainability for Residential Buildings*. Please e-mail any feedback or suggestions you may have regarding the content, format, or methodology of the document to [FEMA-Buildingsciencehelp@dhs.gov](mailto:FEMA-Buildingsciencehelp@dhs.gov) or call our office hotline at 866-927-2104. Comments are encouraged and will be considered in the development of future editions.



FEMA

FEMA P-798  
Catalog No. 10250-1