



Local Officials Guide for Coastal Construction

Design Considerations, Regulatory Guidance, and
Best Practices for Coastal Communities

FEMA P-762 / February 2009



FEMA

Local Officials Guide for Coastal Construction

Design Considerations, Regulatory Guidance, and
Best Practices for Coastal Communities

FEMA P-762 / February 2009

Cover Photo: Courtesy of Jennifer Smits/FEMA



FEMA

Any opinions, findings, conclusions, or recommendations expressed in this publication do not necessarily reflect the views of FEMA. Additionally, neither FEMA nor any of its employees makes any warrantee, expressed or implied, or assumes any legal liability or responsibility for the accuracy, completeness, or usefulness of any information, product, or process included in this publication. Users of information from this publication assume all liability arising from such use.

Acknowledgements

The preparation of this document was sponsored by the FEMA Mitigation Directorate. It has been developed based on the work of several recent publications, new insights from recent hurricanes, the post-disaster assessment findings of FEMA Mitigation Assessment Teams, and other sources of information on residential coastal construction. The principal contributing authors of the supporting reference documents are gratefully acknowledged.

For this manual, the following individuals are acknowledged:

Primary Authors:

Scott Tezak, URS Corporation – Project Manager

David K. Low, DK Low & Associates, LLC

Adam Reeder, PBS&J

Contributors:

Chris Hudson – FEMA Headquarters – Project Monitor

John Ingargiola – FEMA Headquarters

Jacob Anderson – FEMA Headquarters

Marcus Barnes – FEMA Headquarters

Ken Wallace – FEMA Region III

Mark Vieira – FEMA Region IV

John Plisich – FEMA Region IV

Chuck Gregg – FEMA Region VI

Jeffrey Lusky – FEMA Region IX

Byron Hilado – PBS&J

Mike J. Robinson – PBS&J

Rebecca Quinn – RCQuinn Consulting

Wanda Edwards – Institute for Business and Home Safety (IBHS)

William Coulbourne – Applied Technology Council

Chris Jones – Christopher P. Jones

Project Review Committee

The authors and editors gratefully acknowledge the invaluable assistance and advice provided by the following reviewers:

Jhun De La Cruz – FEMA Headquarters

Lois Forster – FEMA Headquarters

Tim Tolbert – City of Santa Rosa, Florida

Joe Lamb – City of Port Aransas, Texas

William York – W.H. York Consulting

Timothy Reinhold – Institute for Business and Home Safety (IBHS)

Randy Noelle – Builder

Stuart McDonald –Mercedes Homes

Mike Rimoldi – FLASH

David Conover – International Code Council (ICC)

Steve Van Note – International Code Council (ICC)

Phil Line – American Forest & Paper Association (AF&PA)

Kenneth Ford – National Association of Home Builders (NAHB)

Dana Bres – U.S. Department of Housing and Urban Development (HUD/PATH)

Steve Mitchell – City of Pascagoula, Mississippi

Don Burrell – City of Beaumont, Texas

Lalo Flores – Missouri City, Texas

Edward Beasley – City of Portland, Texas

Robert Daehn – City of Kingsville, Texas

San Nelson – Texas Department of Insurance

Robert Smalley – City of Chesapeake, Virginia

Contents

1 Introduction

1.1	Objectives	1-1
1.2	Target Audience	1-1
1.3	Scope.....	1-1
1.4	Using the Guide.....	1-2
1.5	Coastal Construction versus Inland Construction	1-4
1.6	Building Codes.....	1-5

2 Coastal Hazards and Considerations

2.1	Flood Hazards: General Design Considerations.....	2-1
2.2	Wind Hazards: General Design Considerations	2-19
2.3	Other Hazards.....	2-32

3 Investigating Regulatory Requirements

3.1	Floodplain Management Requirements and Building Codes.....	3-1
3.2	Building Codes and Standards	3-11
3.3	Coastal Barrier Resources Act of 1982	3-18
3.4	Coastal Zone Management Regulations	3-19
3.5	Use of the National Flood Insurance Program and Code Crosswalk	3-20

4 Permits and Inspections

4.1	Introduction.....	4-1
4.2	Coastal Building Official/Floodplain Administrator s Responsibilities	4-2
4.3	Freeboard.....	4-5
4.4	The Pre-development Conference/Pre-application Meeting	4-6
4.5	Coastal Construction Permit Application Steps.....	4-8
4.6	Permit Plan Submittal Requirements.....	4-8
4.7	Elevation Certificates	4-10
4.8	Inspections	4-11
4.9	Enforcement and Violations.....	4-14
4.10	Variance Process	4-15
4.11	Supplemental Information	4-16

5 Coastal Construction and Continuous Load Paths

5.1	Continuous Load Path.....	5-1
5.2	Types of Load Paths	5-4
5.3	Identifying Load Paths in Buildings	5-5
5.4	Building Codes and Standards	5-7
5.5	Continuous Load Paths and Building Success	5-8

6 Coastal Foundations and Best Practices

6.1	Introduction	6-1
6.2	Building Codes and Coastal Foundations	6-2
6.3	Foundations in Coastal Areas	6-2
6.4	Elevating Buildings in Coastal Areas.....	6-5
6.5	Soils Investigation	6-24

7 Building Framing Systems and Best Practices

7.1	Introduction	7-1
7.2	Diaphragms and Shear Walls.....	7-2
7.3	Roof Construction.....	7-4
7.4	Wall Construction.....	7-8
7.5	Floor Construction	7-18

8 Roof Coverings and Best Practices

8.1	Introduction	8-1
8.2	Roof Coverings: General Code Requirements	8-3
8.3	Re-roofing Code Requirements and Best Practices	8-12

9 Exterior Cladding Components and Best Practices

9.1	Introduction	9-1
9.2	Exterior Wall Coverings and Claddings	9-1
9.3	Exterior Covering and Best Practices.....	9-6
9.4	Exterior Floor Coverings	9-11
9.5	Soffits	9-12
9.6	Concrete and Masonry Walls.....	9-12

10 Windows and Doors

10.1	Introduction	10-1
10.2	Window and Door Failure.....	10-1
10.3	Windborne Debris Protection Systems.....	10-4
10.4	Protection Requirements for Windborne Debris	10-6
10.5	Window and Door Leakage	10-11
10.6	Window and Door Assembly Capacities.....	10-12
10.7	Garage Doors	10-14
10.8	Additional Resources	10-16

Figures

2-1	Floodplain along an open coast.....	2-2
2-2	Long Beach, Mississippi: Aerial photo of apartment complex	2-3
2-3	Gulf Shores, West Beach, Alabama: Aerial overview	2-4

2-4 Gulf Shores, West Beach, Alabama: Insufficient pile embedment2-4

2-5 Orange Beach, Alabama: Collapse of five-story, multi-family building2-5

2-6 Orange Beach, Alabama: Collapse of five-story, multi-family building2-5

2-7 Hydrostatic loads on buildings2-6

2-8 Hydrodynamic loads on a building or building element2-7

2-9 Gulfport, Mississippi: Floodborne debris.....2-8

2-10 Example of surge, wave, and debris damage.....2-9

2-11 Example of surge, wave, and debris damage.....2-9

2-12 Big Lagoon, Alabama: Buildings constructed on piles2-9

2-13 Orange Beach, Alabama: Significant erosion caused a parking slab to fail2-11

2-14 Gulf Shores, Alabama: House on pile foundation.....2-11

2-15 Gulf Shores, Alabama: House on pile foundation.....2-11

2-16 Coastal wave height and stillwater depth.....2-12

2-17 Flood probability chart.....2-14

2-18 Example of a Digital Flood Insurance Rate Map (DFIRM).....2-17

2-19 Coastal flood hazard areas2-17

2-20 Hurricane-prone regions and special wind regions2-21

2-21 Wind-induced pressures on a building.....2-23

2-22 Wind pressure as a function of wind speed.....2-25

2-23 Internal pressure condition when the dominant opening is in the windward wall2-28

2-24 Internal pressure condition when the dominant opening is in the leeward wall.....2-29

2-25 Ocean Springs, Mississippi: Apartment complex severely damaged by wind.....2-31

2-26 Gulf Shores, Alabama: Partition walls destroyed by interior pressurization2-31

2-27 New Orleans, Louisiana: Neighborhood with homes and vehicles flooded.....2-33

3-1 Minimum NFIP V Zone Requirements.....3-6

3-2 Minimum NFIP A Zone Requirements.....3-8

3-3 Recommended Elevation for Buildings in Coastal A Zones and V Zones.....3-10

3-4 The hurricane-prone regions along the coastline of the United States.....3-17

4-1 Permitting and Construction Process Overview4-9

5-1 Dade County, Florida, Hurricane Andrew (1992): Load path failure at end gable5-2

5-2 North Carolina, Hurricane Fran (1996): Load path failure in a foundation5-2

5-3 Punta Gorda, Florida: Roof framing damage and loss due to load path failure 5-3

5-4 Punta Gorda, Florida: Load path failure in connections for a roof system 5-3

5-5 Pass Christian, Mississippi: Newer home damaged from internal pressurization 5-4

5-6 Loads applied to the exterior walls of a building 5-5

5-7 Technical Fact Sheet No. 10, Page 1 5-6

5-8 Technical Fact Sheet No. 10, Page 2 5-7

5-9 Big Lagoon, Florida: Elevated building, constructed to newer code..... 5-9

5-10 Big Lagoon, Florida: This house was elevated on piles..... 5-9

5-11 Big Lagoon, Florida: This house was elevated on piles..... 5-9

6-1 Recommended open-foundation practice for buildings in the Coastal A Zone and V Zone 6-4

6-2 Navarre Beach, Florida: Slab-on-grade foundation failure due to erosion 6-4

6-3 Navarre Beach, Florida: Close-up of foundation failure shown in Figure 6-2..... 6-5

6-4 Plaquemines Parish, Louisiana: Home that had been elevated on fill 6-6

6-5 Building failure caused by undermining of crawlspace foundation during Hurricane Fran..... 6-8

6-6 Failure of crawlspace foundation, which was undermined by scour..... 6-8

6-7 Typical stem wall foundation..... 6-10

6-8 Fort Myers Beach, Florida: Oceanfront house constructed on an open foundation..... 6-11

6-9 Fort Myers Beach, Florida: Newly constructed house elevated on an open foundation..... 6-12

6-10 Dauphin Island, Alabama: Successful pile foundation following Hurricane Katrina..... 6-13

6-11 Dauphin Island, Alabama: Structure near collapse due to insufficient pile embedment..... 6-13

6-12 Long Beach, Mississippi: Structure removed from its foundation by wave action 6-14

6-13 Pile installation methods 6-15

6-14 Diagonal bracing schematic..... 6-17

6-15 Knee brace connection example 6-18

6-16 Elevation view (right) of a concrete pile foundation using grade beams..... 6-19

6-17 Successful use of a breakaway wall..... 6-21

6-18 Building damages due to the incorrect construction of a breakaway wall..... 6-21

6-19 Possible failure modes for masonry piers 6-22

6-20 Pass Christian, Mississippi: Performance comparison of shallow, open foundations..... 6-23

6-21 Belle Fontaine Point, Jackson County, Mississippi: Column connection failure..... 6-23

7-1 Load transfer between diaphragms and shear wall 7-2

7-2 Horizontal diaphragm and diaphragm components..... 7-3

7-3 Vertical shear walls and shear wall components..... 7-3

7-4 Loss of roof sheathing due to inadequate fastening..... 7-4

7-5 Exterior views of connection between roof sheathing and roof trusses 7-6

7-6 Interior views of connection between roof sheathing and roof trusses 7-6

7-7 Detail of masonry wall-to-roof trusses 7-7

7-8 Horizontal loadings exerted on exterior walls 7-9

7-9 Segmented shear walls 7-10

7-10 Perforated shear walls 7-10

7-11 Shear wall anchor 7-12

7-12 Example of balloon framing..... 7-13

7-13 Additional bracing at a gable end wall 7-13

7-14 Improperly braced gable walls..... 7-14

7-15 Residential use of a moment frame 7-15

7-16 Uplift connections around framed opening..... 7-16

7-17 Designed of a reinforced masonry wall system 7-18

7-18 Wooden I-joists used for floor framing 7-20

8-1 Instance where wind pressures exceeded the strength of the asphalt roofing..... 8-2

8-2 Gulfport, Mississippi: Winds dislodged roof-mounted equipment 8-2

8-3 Example of an augmented underlayment installation 8-5

8-4 Example of proper shingle installation..... 8-6

8-5 Roof failures that resulted from improper starter-strip installation..... 8-7

8-6 Roof failures that resulted from asphalt shingles being installed in a raking fashion..... 8-7

8-7 Loss of asphalt shingle roofing along hip 8-7

8-8 Clay tile roof failure. The tiles were dislodged due to inadequate anchorage 8-8

8-9 Storm damage to a tile roof system..... 8-9

9-1 Examples of moisture barrier systems 9-4

9-2 Examples of moisture barrier systems 9-4

9-3 Proper siding lapping to prevent moisture penetration 9-5

9-4 Roof flashing..... 9-7

9-5 Window flashing details 9-7

9-6 Comparison of typical high-wind siding verses standard siding 9-8

9-7 The center of the nailing slot is the proper fastener location 9-8

9-8 Proper fastener clearance..... 9-8

9-9 Example of wood siding on a wood-framed house 9-9

9-10 Figure illustrating the layout of brick ties at house under construction 9-10

9-11 Waveland, Mississippi: House with collapsed brick veneer due to insufficient wall ties..... 9-10

9-12 Example of an exterior floor covering system damaged by Hurricane Ivan 9-11

10-1 Punta Gorda, Florida: Failure of a roof structure from pressurization 10-2

10-2 Puerto Rico: Failure due to inadequate pressure rating of window..... 10-3

10-3 Punta Gorda, Florida: Glazing failure due to windborne debris from displaced roofing 10-3

10-4 Glazing failure due to windborne debris 10-3

10-5 Pensacola, Florida: Example of an insufficient shuttering system 10-7

10-6 Pensacola, Florida: Failure of glazing from windborne debris..... 10-10

10-7 Punta Gorda Isles, Florida: Anchorage failure in sliding glass door failure 10-12

10-8 Negative pressure failure of garage door..... 10-15

10-9 Positive pressure failure of garage door..... 10-15

Tables

2-1 Enhanced Fujita Scale 2-20

2-2 Saffir-Simpson Hurricane Scale 2-22

2-3 Wind Pressure Example for Exposure B..... 2-26

2-4 Wind Pressure Example for Exposure C 2-27

3-1 Code Crosswalk 3-22

10-1 Tables 2 and 3 from ASTM E1996 10-9

Appendix:..... A-1

Introduction

The devastating effects of recent hurricanes—especially hurricanes Charley (2004), Ivan (2004), Katrina (2005), Rita (2005), and Ike (2008)—have underscored the vulnerability of the nation's coastal areas. This guide provides local building officials and floodplain managers with information about the design and construction of hazard-resistant residential structures within the coastal environment. The primary coastal hazards this guide will highlight are high winds and flooding. The building types the guide focuses on are detached single-family, attached single-family (townhouses), and low-rise multi-family structures (i.e., those containing three or fewer stories). Many of the principles discussed herein also apply to non-residential structures; however, those structures are covered in other Federal Emergency Management Agency (FEMA) publications.

1.1 Objectives

The primary objective of this guide is to assist local officials and community decision makers in coastal areas in adopting and implementing sound mitigation measures to lower the vulnerability of buildings to disasters.

The goals of this guide are to:

- Introduce and discuss how requirements in the 2006 editions of the International Residential Code (IRC) and International Building Code (IBC) promote hazard-resistant design and construction in coastal areas
- Recommend building design and construction techniques that can improve the performance of structures during and after flooding and high-wind events
- Provide guidance for implementing flooding and high-wind mitigation best practices into the process of designing and constructing residential buildings

1.2 Target Audience

The target audience of this publication is state and local government officials working within the building sector. The guide is meant to assist them in implementing floodplain management requirements within the coastal environment. This guide describes mitigation measures and the application of building code requirements that have been successful in the past and could be implemented quickly, especially in areas recovering from a disaster. New homes and homes repaired after being damaged by flood and wind must be constructed to comply with current building codes, standards and the National Flood Insurance Program (NFIP) regulations.

1.3 Scope

This guide presents an overview of the principal planning and design considerations for improving the performance of residential buildings during flooding and high-wind events and their aftermaths. It provides information that directs local officials on where to find resources for design guidance and

also presents practical recommendations for protecting buildings and their occupants against hazards typically found in coastal zones.

Some people choose to live in high-hazard areas, while others reside there out of necessity. The intent of this guide is to provide technical information to local building officials who oversee construction in these areas. This information is FEMA's recommended best-practices for coastal construction that when implemented should improve building safety and reduce future losses. While this guide focuses primarily on new construction, the principles described herein also apply to the renovation of existing buildings. The guide emphasizes the importance of incorporating mitigation measures against flooding and high winds into the planning and design of buildings.

The guide provides readers with information about the natural forces acting upon coastal structures and the methods and processes available to protect those structures. This information is, by necessity, limited. It is **not** expected that the reader would be able to use this information directly to develop plans and specifications. Instead, it serves as an introduction to the fundamentals of risk mitigation planning and design. This guide will aid building officials and regulatory professionals as they interact with design professionals, procurement personnel, and project administrators. It will also help to provide a better grasp of planning and construction techniques that will aid building officials and regulatory professionals as they work to improve the safety and welfare of their coastal communities.

1.4 Using the Guide

This guide is generally divided into the following sections:

- An initial explanation of coastal hazards (Chapter 2)
- An introduction to regulatory requirements and inspection issues (Chapters 3 and 4)
- Evaluations of various components of residential building construction (Chapters 5, 6, 7, 8, 9, and 10)

While this guide is not meant to serve as a design manual, it is intended to help readers understand the general concept of mitigating coastal hazards and its applicability to building components. Whenever possible, the guide refers readers to design codes and standards and other relevant materials. Margin notes provide additional information or call attention to important concepts.

The *Local Officials Guide for Coastal Construction* is part of a family of FEMA mitigation guides and reports. These publications are referenced within the guide in order to assist the reader in finding other helpful mitigation information.

FEMA publications referred to in this guide:

- FEMA, *Coastal Construction Manual: Principles and Practices of Planning, Siting, Designing, Constructing, and Maintaining Residential Buildings in Coastal Areas*, FEMA 55 (3rd Edition), Washington, DC, August 2005
- FEMA, *Manufactured Home Installation in Flood Hazard Areas*, FEMA 85, Washington, DC, September 1985 (a revision is expected in 2009)

- FEMA, *Homebuilders Guide to Earthquake Resistant Design and Construction*, FEMA 232, Washington, DC, August 2008
- FEMA, *Engineering Principles and Practices of Retrofitting Flood-prone Structures*, FEMA 259, Washington, DC, January 2001
- FEMA, *Mitigation Assessment Team Report: Hurricane Fran in North Carolina*, FEMA 290, Washington, DC, April 1997
- FEMA, *Floodplain Management Bulletin on the Elevation Certificate*, FEMA 467-1, Washington, DC, May 2004
- FEMA, *Mitigation Assessment Team Report: Hurricane Charley in Florida*, FEMA 488, Washington, DC, April 2005
- FEMA, *Mitigation Assessment Team Report: Hurricane Ivan in Alabama and Florida*, FEMA 489, Washington, DC, August 2005
- FEMA, *Home Builders Guide to Coastal Construction Technical Fact Sheet Series*, FEMA 499, Washington, DC, August 2005
- FEMA, *Design Guide for Improving Critical Facility Safety from Flooding and High Winds: Providing Protection to People and Buildings*, FEMA 543, Washington, DC, January 2007
- FEMA, *Mitigation Assessment Team Report: Hurricane Katrina in the Gulf Coast*, FEMA 549, Washington, DC, July 2006
- FEMA, *Recommended Residential Construction for the Gulf Coast: Building on Strong and Safe Foundations*, FEMA 550, Washington, DC, July 2006
- FEMA, NFIP Technical Bulletin 1: *Openings in Foundation Walls and Walls of Enclosures*, FIA-TB-1, Washington, DC, August 2008
- FEMA, NFIP Technical Bulletin 2: *Flood Damage-Resistant Materials Requirements for Buildings Located in Special Flood Hazard Areas*, FIA-TB-2, Washington, DC, August 2008
- FEMA, NFIP Technical Bulletin 5: *Free-of-Obstructions Requirements for Buildings Located in Coastal High Hazard Areas*, FIA-TB-5, Washington, DC, August 2008
- FEMA, NFIP Technical Bulletin 9: *Design and Construction Guidance for Breakaway Walls Below Elevated Coastal Buildings*, FIA-TB-9, Washington, DC, August 2008

1.5 Coastal Construction versus Inland Construction

Coastal structures are subject to extreme hazards and loads. Due to the intensity of these conditions, coastal construction involves additional design considerations:

- Wave action exerts tremendous loads upon the foundations of coastal structures. Such loadings have been known to cause significant damage to these structures.
- Erosion and scour can remove soil, causing undermining of some foundations of residential buildings and increasing the unbraced length on open foundations. Subsidence and rising sea and water levels can potentially increase flood depths, creating additional flood loads on the residential structure.
- Waterborne debris can exert an impact and produce repetitive loads not seen in inland residential construction.
- Wind speeds are typically higher in coastal areas and require stronger engineered building connections and more closely spaced fasteners of building sheathing, siding, and roof systems.
- Wind-driven rain, airborne salts, corrosion, and decay are constant concerns within coastal areas.

To address such differences in loading criteria, homes in coastal areas must be designed and built to withstand extreme conditions. This guide outlines the minimum building requirements for structures and suggests best practices to improve a structure's resistance to future storm events. Exceeding these minimum requirements can result in several economic benefits:

- Reduced damage during coastal storm events
- Reduced building maintenance
- Longer building lifetime
- Improved Community Rating System (CRS) score
- Reduced insurance premiums

Although this guide discusses in detail building design and construction issues, it also addresses other aspects of coastal construction such as planning, zoning, and achieving compliance with local ordinances. These considerations are also important because even a well-built building can sustain significant damage or collapse if it is poorly sited. The impacts of erosion and scour should be seriously considered during the planning process.

1.6 Building Codes

This guide primarily references two codes: The International Building Code (IBC) and the International Residential Code (IRC). Achieving familiarity with other relevant materials from the American Society of Civil Engineers (ASCE) and regulations from the NFIP is important when implementing a comprehensive approach to coastal residential construction. The state in which the local official is working may use other codes or standards on either a state or local level. If your location does not use these codes, this guide will still provide insight into best practices in coastal construction methods and suggest appropriate design considerations.

Codes referred to in this guide are:

- International Code Council, *International Building Code*, Country Club Hills, IL, 2006
- International Code Council, *International Residential Code*, Country Club Hills, IL, 2006
- International Code Council, *International Existing Building Code*, Country Club Hills, IL, 2006
- NFPA, *Building Construction and Safety Code*, NFPA 5000, Quincy, MA, 2005

Standards referred to in this guide are:

- American Society of Civil Engineers, Structural Engineering Institute, *Minimum Design Loads for Buildings and Other Structures*, ASCE/SEI 7-05, Reston, VA, 2005
- American Society of Civil Engineers, Structural Engineering Institute, *Flood Resistant Design and Construction*, ASCE/SEI 24-05, Reston, VA, 2005
- American Concrete Institute/American Society of Civil Engineers/The Masonry Society, *Building Code Requirements for Masonry Structures*, ACI 530/ASCE 5/TMS 402, Farmington Hills, MI, updated 2008
- American Forest & Paper Association, *Wood Frame Construction Manual for One- and Two-Family Dwellings* (WFCM), Washington, DC, 2001
- American Iron and Steel Institute, *Standard for Cold-Formed Steel Framing: Prescriptive Method for One- and Two-Family Dwellings (COFS/PM) with supplement to Standard for Cold-Formed Steel Framing – Prescriptive Method for One- and Two-Family Dwellings*, AISI S 230-07, Washington, DC, updated 2007
- American National Standards Institute (ANSI)/Single Ply Roofing Industry (SPRI), *Wind Design Standard for Ballasted Single-Ply Roofing Systems*, ANSI/SPRI RP-4, Waltham, MA, 2002
- ANSI/Door and Access Systems Manufacturers Association (DASMA), *Standard Method for Testing Sectional Garage Doors: Determination of Structural Performance Under Uniform Static Air Pressure Difference*, ANSI/DASMA 108, Waltham, MA

- American Society for Testing and Materials (ASTM), *Standard Test Method for Wind-Resistance of Asphalt Shingles (Fan-Induced Method)*, ASTM D3161, West Conshohocken, PA
- ASTM, *Standard Test Method for Wind Resistance of Asphalt Shingles (Uplift Force/Uplift Resistance Method)*, ASTM D7158, West Conshohocken, PA
- ASTM, *Standard Test Method for Structural Performance of Exterior Windows, Doors, Skylights, and Curtain Walls by Uniform Static Air Pressure Difference*, ASTM E330, West Conshohocken, PA
- ASTM, *Standard Test Method for Performance of Exterior Windows, Curtain Walls, Doors, and Impact Protective Systems, Impacted by Missile(s) and Exposed to Cyclic Pressure Differentials*, ASTM E1886, West Conshohocken, PA
- ASTM, *Standard Specification for Performance of Exterior Windows, Curtain Walls, Doors, and Impact Protective Systems Impacted by Windborne Debris in Hurricanes*, ASTM E1996, West Conshohocken, PA
- ASTM, *Standard Practice for Installation of Exterior Windows, Doors, and Skylights*, ASTM E2112, West Conshohocken, PA
- American Architectural Manufacturers Association/Window & Door Manufacturers Association/Canadian Standards Association, *Standard/Specification for Windows, Doors, and Unit Skylights*, AAMA/WDMA/CSA 101/I.S. 2/A440, Schaumburg, IL, March 2007
- National Fire Protection Association (NFPA), *Model Manufactured Home Installation Standard*, NFPA 225, Quincy, MA, 2005

Additional resources referred to in this guide:

- International Code Council, and FEMA, *Reducing Flood Losses Through the International Code Series: Meeting the Requirements of the National Flood Insurance Program* (2nd Edition), Country Club Hills, IL, 2005
- American Institutes for Research, *Evaluation of the National Flood Insurance Program*, December 2006
- Applied Technology Council, *ATC-45 Field Manual: Safety Evaluation of Buildings After Wind Storms and Floods*, Redwood City, CA, 2007
- North Carolina State University/Oregon State University, *Behavior or Breakaway Walls Subjected to Wave Forces: Analytical and Experimental Studies*, Tung et al., Raleigh, NC, 1999

Coastal Hazards and Considerations

This chapter describes the hazards associated with coastal areas and the issues that local officials must consider when they work in this environment. The chapter enlightens the reader on the flood and wind hazards associated with coastal areas and provides a brief summary of other hazards that could potentially impact construction methods at the end of the chapter.

2.1 Flood Hazards: General Design Considerations

This section introduces the physical nature and characteristics of coastal floods. It also describes the types of flood damage that can result when buildings are located within coastal flood hazard areas.

2.1.1 The Nature of Flooding

Flooding is the most common natural hazard to occur in the United States, affecting more than 20,000 local jurisdictions covered under the National Flood Insurance Program (NFIP) and representing more than 70 percent of presidential disaster declarations. Flooding is a natural process that may occur in a variety of forms. This guide focuses on coastal flooding from hurricanes and tropical storms. Increased development along our nation's coastlines creates potentially life-threatening situations and renders property vulnerable to serious damage or destruction.

Flooding along shorelines is usually the result of coastal storms that generate storm surge or waves. Several factors can affect the frequency and severity of damage that ensues as a result of coastal flooding:

- Erosion of shorelines, often resulting in significant losses of soil with a single event
- Rising sea levels
- Deposition of sediment from receded waves or water, or sediment that is carried inland by wave action
- Land subsidence, which increases flood depths
- Failure of levees that may result in the sudden flooding of areas behind levees

NOTE

Flood frequency analyses are performed using historical records and hydrological analysis, and the results are influenced by the length of the record. Such analyses do not account for recent changes to the land (such as shifting of barrier islands due to storms) or future changes (including development, greater subsidence, or climatic variations).

Coastal flooding has distinct characteristics that should be considered in the selection of building sites, design of new buildings, and substantial repair or modification of existing floodprone buildings.

Coastal flooding occurs along the Atlantic, Gulf, and Pacific coasts and many large lakes, including the Great Lakes. Coastal flooding is influenced by storm surges associated with tropical cyclonic weather systems (e.g., hurricanes, tropical storms, tropical depressions, and typhoons), extratropical systems (i.e., nor easters), and tsunamis (which are surges induced by seismic activity). Coastal flooding is primarily characterized by wind-driven waves. Along the reaches of the Great Lakes, winds blowing across broad expanses of water can generate waves rivaling those of ocean shorelines. Figure 2-1 is a schematic of a generic coastal floodplain. Section 2.1.3.1 provides additional information on depth of flooding in mapped areas.

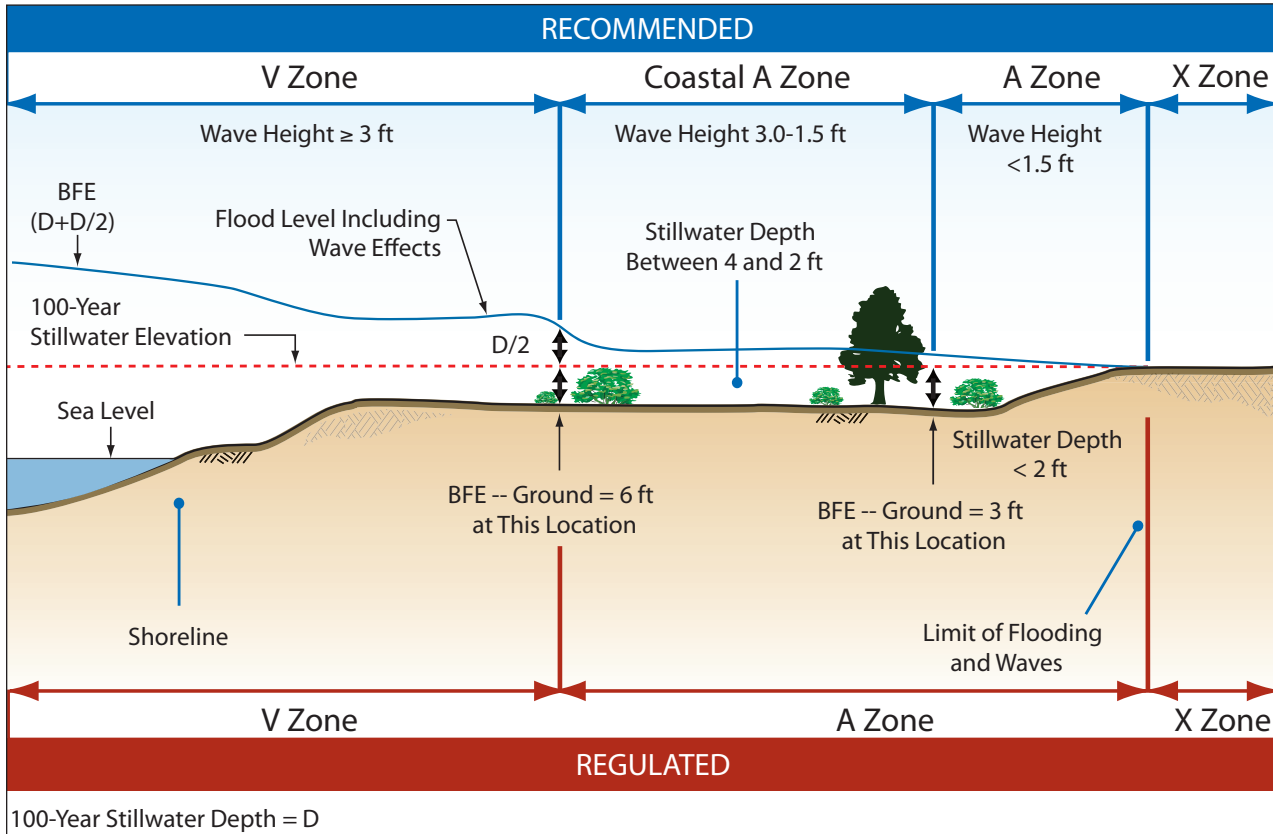

Figure 2-1. Floodplain along an open coast. (Flood zones identified in this figure are discussed in Subsection 2.1.4.3 of this guide.)

2.1.2 Flood Characteristics and Loads

Characteristics associated with coastal flooding are important in the analysis of sites for buildings and in the determination of flood loads that must be considered as part of the architectural and engineering design. These characteristics are described below.

Depth. The most noticeable characteristic of any flood is water depth. The depth of coastal flooding is influenced by such factors as storm strength, tidal cycle, storm duration, land elevation, and the presence of waves. Depth is a critical factor in building design because the flood forces acting upon a vertical surface (such as a foundation wall, column, post, pier, or pile) are directly related to depth. Costs associated with protecting buildings from flooding typically increase with depth. Under certain conditions, hurricanes



Figure 2-2.
LONG BEACH, MISSISSIPPI:
Aerial photo of apartment
complex and surrounding
area after Hurricane Katrina.
(Source: FEMA 549)

can produce storm-surge flooding that is 20 to 30 feet above mean sea level or, in extreme cases along the Gulf Coast, as much as 35 feet above mean sea level (see Figure 2-2). These storm-surge events can result in significant water depths within low-lying coastal areas.

Duration. Duration is defined as the recorded length of time of above normal water levels. Most coastal flooding is influenced by the normal tidal cycle as well as how fast coastal storms move through that particular region. Areas subject to coastal flooding can experience long-duration flooding in which drainage is poor or slow as a result of topography or the presence of flood control structures. For example, there may be depressions in the land that could hold water or situations in which water could be trapped behind a floodwall or levee with inadequate drainage. More commonly, coastal flooding is of shorter duration usually 12 to 24 hours especially if storms move rapidly. For building design, duration is important because it affects access, building usability, saturation and stability of soils, and selection of building materials. In the mid-Atlantic and New England states, however, nor easters can result in flooding that lasts for more than 3 days.

Velocity. Floodwater velocity ranges from extremely high (associated with storm surges of 10 feet per second or more) to very low or nearly stagnant (in backwater areas and expansive floodplains). In this context, velocity refers not to the motion associated with breaking waves but to the speed of the mass movement of floodwater across an area. Velocity is important in site planning because of the potential for erosion. In structural design, velocity is a factor in determining the hydrodynamic (i.e., moving water) loads and impact loads (which is the force of moving water or the force of floodborne debris hitting a building).

Wave action. Waves contribute not only to erosion and scour but also add significantly to the loads exerted on buildings. The magnitude of wave forces can be 10 to more than 100 times greater than wind and other design loads and thus may control many design parameters. Waves must be considered in site planning along coastal shorelines; waves must also be considered in flood hazard areas that are inland of open coasts and other locations where waves occur, including areas with sufficient open spaces that winds

can generate waves (such as lakes and expansive riverine floodplains). Waves on top of storm surges may be as much as 50 percent higher than the depth of the surge. Figures 2-3, 2-4, 2-5, and 2-6 illustrate the power of wave action on structures.

Impacts from debris. Floating debris contributes to the loads that must be considered in the structure design. The methods and models used to predict and delineate flood hazard areas do not specifically incorporate the effects of debris. Few sources, other than past observations and engineering judgment, are available to determine the potential effects of debris impact loads. More recent model building codes require that foundations be designed to resist a representative impact from floodborne debris.



Figures 2-3 and 2-4.
GULF SHORES, WEST BEACH,
ALABAMA: Insufficient pile
embedment contributed to the
displacement of houses.
(Source: FEMA 489)



Erosion and scour. In coastal areas, *erosion* refers either to the lowering of the ground surface as a result of a flood event or the gradual recession of a shoreline as a result of long-term coastal processes. *Scour* refers to a localized lowering of the ground surface due to the interaction of currents and/or waves with structural elements (such as pilings). Soil characteristics influence an area's susceptibility to scour. Erosion and scour may affect foundation stability and the maintaining of filled areas by removing all support from beneath a foundation, resulting in possible structural damage or building collapse.



Figures 2-5 and 2-6.
ORANGE BEACH, ALABAMA:
Collapse of five-story, multi-family
buildings on shallow foundations.
(Source: FEMA 489)



2.1.2.1 Hydrostatic Loads

Hydrostatic loads occur when water comes into contact with a building or building component, both above and below the ground level. These loads may act as lateral pressure or as upward vertical pressure (buoyancy).

Lateral hydrostatic loads are a direct function of water depth (see Figure 2-7). These loads can cause severe deflection or displacement of buildings or building components if there is a substantial difference in water levels on opposite sides of the component (such as the interior and exterior of a building). Hydrostatic loads are balanced on the foundation elements of elevated buildings, such as piers and columns, because the element is surrounded by water. To reduce excessive pressure from standing water, minimum NFIP requirements in A Zones require the use of flood openings along continuous foundations, as well as for enclosed areas below the flood elevation.

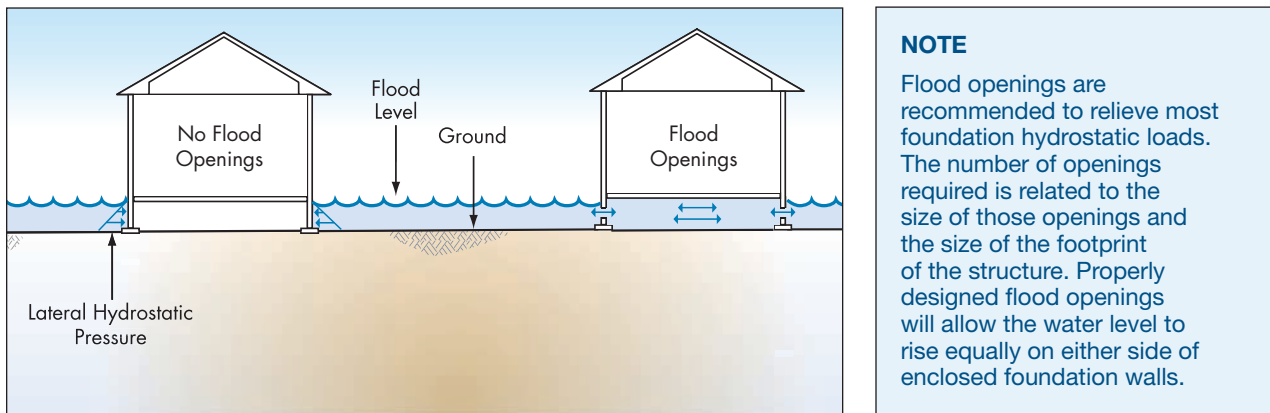

Figure 2-7. Hydrostatic loads on buildings.

Buoyancy forces resulting from the displacement of water is also a matter of concern, especially for basements, dry swimming pools, and aboveground and underground tanks. Buoyancy forces are resisted by the dead load of the building or the weight of the tank. When determining resistance to buoyancy forces, the weights of occupants or other live loads are not considered. If the building or tank does not weigh enough when empty, additional stabilizing measures must be taken to prevent flotation. Further, when combining loads in the design process, typically only 60 percent of the building's dead load may be used to resist flood-related loading; this becomes a significant consideration for designs intended to dry floodproof a building. It should be noted that buoyancy force is slightly greater in saltwater because saltwater is more dense than fresh water.

2.1.2.2 Hydrodynamic Loads

Water flowing around a building or a structural element that extends below the flood level imposes hydrodynamic loads. The loads, which are a function of flow velocity and structure geometry, include frontal impact on the upstream face, drag along the sides, and suction on the downstream side (see Figure 2-8).

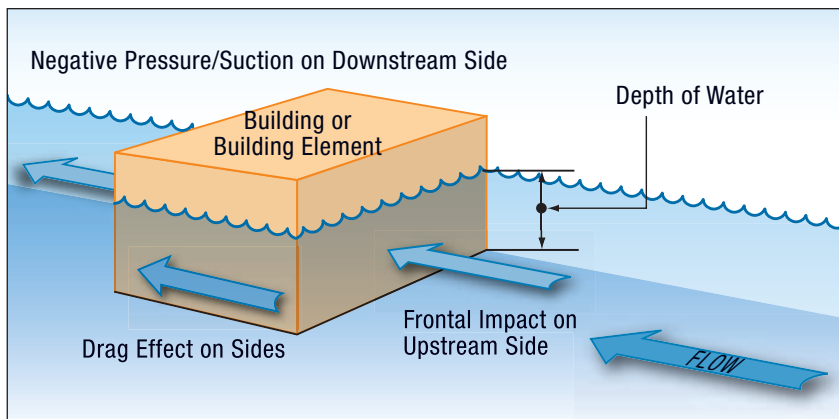

Figure 2-8.
Hydrodynamic loads on a building or building element. (Source: FEMA 543)

The computation methods for hydrodynamic loads are outlined in the design standard ASCE 7-05. Those methods assume that the flood velocity is constant (i.e., steady state flow) and that the dynamic load imposed by floodwaters moving at less than 10 feet per second can be converted to the equivalent hydrostatic load. According to ASCE 7-05, hydrodynamic loads become important when flow rate exceeds 5 feet per second; for velocities less than 5 feet per second, the standard allows the load to be calculated as a hydrostatic load, as outlined in ASCE 7-05 Section 5.4.2

NOTE

Drag coefficients for common building elements, such as columns and piers, can be found in a number of sources. ASCE 7-05 and FEMA 55 recommend some drag-coefficient values.

2.1.2.3 Wave Loads

When waves strike building elements, the force can be 10 to 100 or more times higher than wind and other forces. Forces of this magnitude can be significant, even when acting over the relatively small surface area of the open foundation of an elevated building. Post-storm damage inspections show that breaking wave loads overwhelm nearly all wood-frame and unreinforced masonry walls below the wave crest elevation. Only engineered and massive structural elements are capable of withstanding breaking wave loads.

NOTE

While Coastal A Zones are not formally shown on Flood Insurance Rate Maps (FIRM), in A Zones where wave heights exceed 1.5 feet (such as Coastal A Zones), FEMA recommends using open foundations.

Therefore, in most residential structure design, the preferred method of addressing hydrodynamic loads is to raise the structure above the expected depth of flooding (including waves). The hydrodynamic loads can be so high that it is not possible to resist them in a cost-effective manner. The magnitude of wave forces is the rationale behind the floodplain management requirement for the bottom of the lowest horizontal structural member of the lowest floor to be positioned at or above the design flood elevation in environments where waves are predicted to be 3 feet high or higher (i.e., V Zones). Based upon these factors, the NFIP requires an open foundation design be used within V Zones.

The magnitude of wave loads depends upon the wave height. Equations for wave height are based upon the assumption that waves are depth-limited (on the order of 78 percent of stillwater depth in shallow water break areas) and that waves propagating into shallow water break when the wave height reaches a certain proportion of the underlying stillwater depth. FEMA uses these assumptions to define coastal

high-hazard areas (i.e., V Zones) where breaking waves are predicted to be 3 feet high or higher. At any given site, wave heights may be modified by other factors. Designers should refer to ASCE 7-05 for a detailed discussion and computation procedures. As described in ASCE 7-05, design and construction of buildings and other structures subject to wave loads shall account for the following loads: waves breaking on any portion of the building or structure; uplift forces caused by shoaling waves beneath a building or structure, or portion thereof; wave run up striking any portion of the building or structure; wave-induced drag and inertia forces; and wave-induced scour at the base of a building or structure, or its foundation.

NOTE

Waves only 1.5 feet high can impose considerable loads and damage. A 1.5-foot-high wave can catastrophically fail the wall of a wood-frame (2 by 4) structure. As a result, there is a growing awareness of the value of considering waves in areas referred to as Coastal A Zones (see Subsection 2.1.4.3 of this guide).

Breaking wave loads on vertical walls or supporting structural members reach a maximum when the direction of wave approach is perpendicular. It is common to assume that the direction of approach will be perpendicular to the shoreline, in which case the orientation of the wall to the shoreline will influence the direction of approach used in load calculations. ASCE 7-05 provides a method for reducing breaking-wave loads on vertical walls for waves that approach a building from a direction other than straight-on.

2.1.2.4 Debris Impact Loads

Debris impact loads are imposed on a building or building element by objects carried by moving water. Objects commonly carried by floodwaters include trees, dislodged tanks, and remnants of structures such as docks and buildings, as shown in Figures 2-9, 2-10, 2-11, and 2-12. Extreme impact loads result from less common sources, such as shipping containers, boats, and barges. The magnitude of these loads is difficult to predict, yet some reasonable allowance is required during the design process if model codes are in effect.



Figure 2-9.
GULFPORT, MISSISSIPPI:
Floodborne debris, including shipping containers and sections of destroyed buildings. (Source: FEMA 549)



Figure 2-10.
Example of surge, wave, and debris damage.
(Source: FEMA 549)



Figure 2-11.
Example of surge, wave, and debris damage.
(Source: FEMA 489)



Figure 2-12.
BIG LAGOON, ALABAMA: Buildings constructed on piles and elevated several feet above the base flood elevation (BFE) sustained less flood damage than adjacent buildings at lower elevations. (Source: FEMA 489)

The location of a building within the potential debris stream influences impact loads. The potential for debris impacts is significant if a building is located immediately adjacent to (or downstream from) other buildings, among closely spaced buildings, or downstream from large floatable objects. Debris impacts those buildings that are located on the open coast and shorelines of back bays.

Debris may impact not only the first row of buildings, but also buildings several rows back. The basic equation to estimate the magnitude of impact loads depends upon designer-selected variables such as coefficients, building or building-element stiffness, debris weight, debris velocity, and duration of impact. The latter three variables (which are described in detail in ASCE 7-05) are briefly described below.

When reviewing plans, the inclusion of debris loads should consider impacts on foundation elements from debris weighing at least 1,000 pounds. Based upon regional conditions, this number could increase in some areas. Chapter C5 of ASCE 7-05 provides some background on impact loads and the assumptions made in calculating them. Standard assumptions are made for most coastal and riverine areas. Special provisions are outlined for areas such as the Pacific Northwest, where large trees and logs are common. The chapter also addresses situations where loads less than the standard 1,000-pound impact force should be considered. Other factors to be considered in the calculation of debris impact loads include the debris velocity, which is the velocity of debris when it strikes a building, and the duration that it takes the debris to stop once it impacts the building.

2.1.2.5 Erosion and Local Scour

Erosion and scour can significantly impact building performance and should therefore be considered during the site evaluation and design. In coastal areas, erosion may affect the ground surface and may cause a short- or long-term recession of the shoreline. In areas subject to gradual erosion of the ground surface, additional foundation-embedment depth can mitigate the effects. Where shoreline erosion is significant, however, engineered solutions are unlikely to prove effective. Avoidance of sites in areas subject to active erosion usually is a safe and cost-effective solution. Although every building site is important, local officials should evaluate areas of known long-term shoreline recession and ensure that elected officials are aware of the potential impacts of poorly sited structures within these areas.

Local scour results from turbulence at the ground level around foundation elements. Determining potential scour is critical in the design of foundations to ensure that failure during and after flooding does not occur as a result of the loss in either bearing capacity or anchoring resistance around the posts, piles, piers, columns, footings, or walls. Scour can also impact a building's lateral stability. A loss of lateral stability can often overstress pile connections with the structure, resulting in the failure of weak or improperly designed connections. In many instances, deeper foundations are recommended to account for significant losses in soil and scour. Figures 2-13, 2-14, and 2-15 show the dramatic impacts of erosion on structures.

At some locations, soil at or below the ground surface can be resistant to local scour, and calculated scour depths based upon unconsolidated surface soils below may be considered excessive. In instances where the local official believes the underlying soil at a site will be scour-resistant, the official should recommend the assistance of a geotechnical engineer or geologist.



Figure 2-13.

ORANGE BEACH, ALABAMA: Significant erosion caused a non-structural parking slab to fail and the structure to lean due to insufficient pile embedment. (Source: FEMA 489)



Figures 2-14 and 2-15.

GULF SHORES, ALABAMA: House on pile foundation, adjacent to breach in the barrier island that experienced erosion and significant non-structural damage below the lowest floor. (Source: FEMA 489)

2.1.3 Design Parameters

Flood hazards and flooding characteristics must be identified to evaluate the impact of site development, determine design parameters necessary to calculate flood loads, design floodproofing measures, and identify and prioritize retrofit measures for existing buildings.

2.1.3.1 Flood Depth

Because nearly every other flood-load calculation depends directly or indirectly upon it, flood depth is the most important factor required to compute loads exerted by flooding. The first step in determining flood depth at a specific site is to identify the flood that is specified (i.e., the design event), which will either be stated in applicable regulations or mandated by the governing authority. The most common flood used for design is the base flood (see Subsection 2.1.4 of this guide). Base flood elevations (BFE) are determined in V and A Zones as the design stillwater flood depth plus the additional wave crest height, which is an additional 55 percent of the stillwater depth. The second step is to determine the ground elevation at the site. Because these pieces of data are usually obtained from different sources, it is important to determine whether they are based on the same vertical datum. If they are not, standard corrections must be applied.

NOTE

When evaluating flood depths or elevations as related to house elevations, it is important to consider which vertical datum is being used. Newer FIRMs use the NAVD88 (while older maps use the NGVD29). This information, which is listed on the FIRM, is considered by the surveyor when structure elevations are taken.

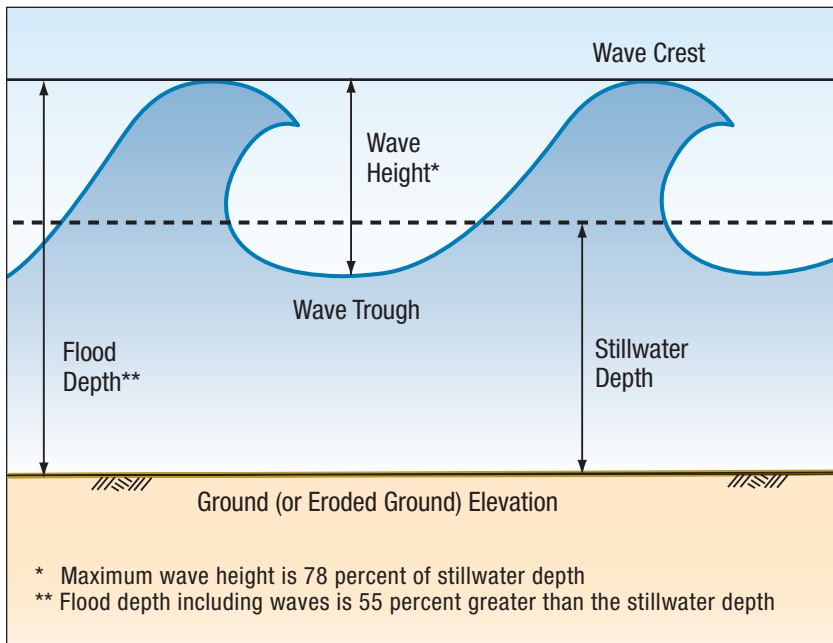

Figure 2-16. Coastal wave height and stillwater depth. (Source: FEMA 543)

NOTE

Waves and storm-induced erosion are most common in coastal areas. However, wide rivers and lakes may experience wind-driven waves, and erodible soils are found throughout the United States. For information about waves and erosion, see FEMA 55, Coastal Construction Manual.

In coastal areas, the flood elevations shown on Flood Insurance Rate Maps (FIRMs) include the depth of waves only if the predicted wave heights are greater than 3 feet. In these areas, shown as V Zones on FIRMs (see Subsection 3.1.4.3 of this guide), the flood depth is composed of a stillwater depth plus the expected height of waves (see Figure 2-16).

The FIRMs also delineate flood hazard areas shown as A Zones; these zones are inland of V Zones or located along shorelines where predicted wave heights are less than 3 feet. When the ground elevation is subtracted from the flood elevation, the result is the stillwater depth. Where waves are expected to range in height from 1.5 feet to 3 feet (i.e., in the Coastal A Zone, as explained in Subsection 2.1.4.3 of this guide), the loading from the waves should be included in the load calculations. Use of only the stillwater depth to determine the flood loads will result in an underestimate of the loads. The relationship shown on Figure 2-16 should be used to estimate wave heights as a function of stillwater depth.

In areas with erodible soils, local officials must consider the effects of erosion where floodwaters lower the ground surface or cause local scour around foundation elements. The flood depth determined using flood elevation and ground elevation should be increased to account for changes in conditions during a flood event. Lowering the ground surface effectively results not only in deeper water against the foundation; it may also remove supporting soil from the foundation, which must be accounted for in the foundation design. While flood maps and the resulting BFEs account for the erosion that occurs during a base flood event, they do not consider long-term erosion. In addition, the maps do not account for site-specific, foundation-specific scour, which should be considered in the design process.

2.1.3.2 Flood Velocity

Estimating flood velocities in coastal flood hazard areas involves considerable uncertainty, and little reliable historical information or data from actual coastal flood events is available. The direction and velocity of floodwaters can vary significantly throughout a coastal flood event. Floodwaters can approach a site from one direction as a storm approaches and then shift to another direction (or several directions) as the storm moves through the area. Floodwaters can inundate some low-lying coastal sites from both the front (e.g., ocean) and the back (e.g., bay, sound, or river). Similarly, at any given site, flow velocities can vary from close to zero to more than 10 feet per second. For these reasons, when determining flood loads for building design, velocities should be estimated conservatively, and it should be assumed that floodwaters can approach from the most design-critical direction.

Despite the uncertainties, there are methods to estimate approximate coastal flood velocities. One common method is based on the stillwater depth (i.e., the flood depth without waves). Local officials should verify that designers considered the topography, distance from the flooding source, and proximity to other buildings and obstructions before selecting the flood velocity for design. Those factors can direct and confine floodwaters, with a resulting acceleration of velocities. This increase in velocities is described as the expected upper bound. Expected lower bound velocities are experienced in areas where those factors are not expected to influence the direction and velocity of floodwaters.

2.1.4 Flood Hazard Maps and Zones

FIRMs identify areas subject to flooding. These locations include the Special Flood Hazard Area (SFHA) representing the land within the floodplain with a 1 percent annual chance of flooding. The flood event that produces the 1 percent annual flood is often called the 100-year flood. FIRMs also include areas between the 100- and 500-year floods and those areas outside those flood extents. NFIP-prepared maps are the minimum basis of state and local floodplain regulatory programs. FIRMs are part of the program to regulate development within the floodplain; in return, property owners are offered insurance protection against losses from flooding. Some communities base their regulations on a flood of record or a historically significant flood that exceeds the base flood shown on NFIP maps.

NOTE

As of 2007, 60.3 percent of the U.S. population had digital geographic information system (GIS) flood data. It is projected that by the end of 2009, 92 percent of the population will have digital GIS flood data.

The FIRMs used by the authority having jurisdiction (AHJ) should be consulted during planning and site selection, site design, and architectural and engineering design (whether for the design of new buildings or the rehabilitation of existing buildings). Regardless of the flood hazard data required for regulatory

purposes, additional research should be conducted on past major floods and other factors that could lead to more severe flooding, and hence impact the flood risk at a particular site.

2.1.4.1 The 100-year Flood

The recurrence interval of a flood is an expression of frequency based on probabilities. This could be defined as the likelihood that an event (in this case, a flood) of a certain magnitude will occur within a given period. The flooding event commonly referred to in the NFIP is the 100-year flood. This designation can be deceptive and give the impression that this type of event will occur only once every 100 years. When calculated, the 100-year flood has a 1 percent chance of occurring or being exceeded within a year. Due to this number being a percent-annual chance, it is possible that a comparable flood could occur at the same location during the next year, or could occur even multiple times during a single year. The laws of probability suggest that as time passes, the chance of one of these events occurring will increase, as shown in Figure 2-17. Note that during the 30-year life of a typical mortgage, there is a 26 percent chance of experiencing a base flood for buildings located in a floodplain.

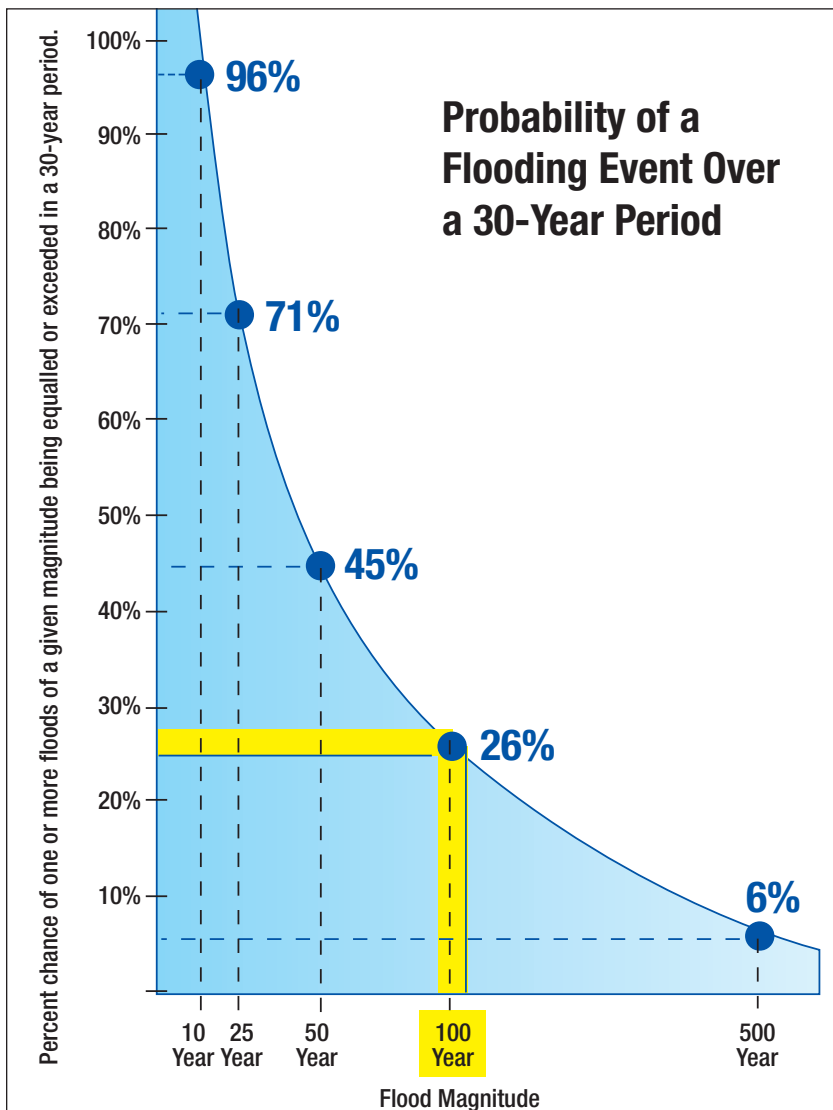

Figure 2-17.
Flood probability chart.
 (Source: U.S. Geological Survey, Guidelines for Determining Flood Flow Frequency, Bulletin 17B (Appendix D)).

NOTE
 Flood maps are available at the FEMA Map Store (<http://www.fema.gov>). For a fee, copies may be ordered online or by calling (800) 358-9616. The Flood Insurance Study (FIS) and engineering analysis used to determine the flood hazard area may be ordered through the FEMA Web site. This information can also be viewed online or downloaded.

NOTE
 The assigned frequency of a flood (e.g., 100-year) is independent of the number of years between actual occurrences. Hurricane Camille hit the Mississippi coast in 1969 with storm surge flooding that far exceeded previous events, and Hurricane Katrina affected much of the same area. Although just 36 years apart, both storms produced flood levels significantly higher than the predicted “100-year flood.”

For coastal areas, both historical storms and simulated storm surge models can be used to predict the probability that floodwaters will rise to a certain level and be accompanied by waves of certain heights. Many coastal storms will produce storm surge flooding that, depending on local topography, may extend inland significantly farther than anticipated for the 100-year flood and may result in flood depths greater than the 100-year flood. Statistically, such extreme storm surges occur less frequently than the 100-year floods, but their consequences can be catastrophic.

Local officials should ensure that planners, designers, and builders understand the relationships between the flood levels for different frequency events and extreme events, especially in hurricane-prone communities. The difference in flood levels may be extreme in some situations, depending on local conditions and the source of flooding. In other areas, the lower probability flood depths may not be much higher than the 100-year flood.

The NFIP uses the 100-year flood as the basis for mapping flood hazards on regulatory maps, for setting insurance rates, and for applying regulations to minimize future flood damage (referred to on the flood maps as the BFE). The extent of the 100-year flood (or BFE) is given one of several designations or zones on the FIRM and collectively are referred to as SFHAs. The SFHAs show the extent of the anticipated 100-year flood while the individual zones provide specific or general information with regard to the expected elevation of flooding. The extent of the SFHA is also used as the standard for examination of older buildings to determine which measures to apply to reduce future damage.

2.1.4.2 Flood Maps

The NFIP produces FIRMs for more than 20,000 communities nationwide. The current effective maps are typically available for viewing in community planning or permit offices. It is important to use the most recent flood hazard map when determining site-specific flood hazard characteristics. Although many FIRMs are more than 15 years old, often one or more panels or portions of a map panel have been revised and republished. Communities must adopt revised maps to continue participating in the NFIP.

Some FIRMs do not show the 0.2-percent-annual-chance flood hazard area (500-year floodplain), and many FIRMs do not provide detailed information about predicted flood elevations along every body of water. When this information is not available, the Flood Insurance Study (FIS) produced to support the FIRMs (by community) should be used. If both the FIRM and FIS data are insufficient, additional statistical methods and engineering analyses may be needed to determine the floodprone areas and the appropriate characteristics of flooding required for site layout and building design.

If a proposed building site or existing building is affected by flooding, a site-specific topographic survey is critical to delineate the land that is below the flood elevation used for planning purposes. If detailed flood elevation information is not available, a floodplain study may be required to identify the important flood characteristics and data required for sound design.

WARNING

Flood Insurance Rate Maps are used for insurance rating purposes; they are not comprehensive tools to identify all hazards associated with floods and the probabilities of occurrence at a particular risk site.

NOTE

Some areas have adopted a Design Flood Elevation (DFE). This is additional elevation, known as freeboard, above the Base Flood Elevation to account for variables and changes to future flood maps. Buildings in these jurisdictions may need to be built to a DFE, which will exceed the 100-year flood elevation.

Having flood hazard areas delineated on a FIRM should not oversimplify the process of understanding the hazard. Flood maps have limitations that should be considered, especially during site selection and design. Some well-known limitations are identified below.

- Flood hazard areas are approximations based on probabilities; the flood elevations shown and the areas delineated should not be taken as absolutes, in part because they are based on numerical approximations of the real world.
- Especially for older maps, the topography used to delineate the flood boundary may have had contour intervals of 5, 10, or even 20 feet (versus 1 or 2 feet), which significantly affects the precision with which the boundary is determined. The actual elevation of the ground relative to the flood elevation is critical, as opposed to whether an area is shown as being in or out of the mapped flood hazard area.
- The scale of maps may impede precise determinations (many older maps are 1 inch = 2,000 feet).
- Flooding characteristics may have been altered by development, sometimes by local modifications that have altered the shape of the land surface of the floodplain (such as fills or levees).
- Local conditions are not reflected, especially conditions that change regularly, such as shoreline erosion.
- Areas exposed to very low probability flooding are not shown, such as flooding from extreme hurricane storm surges, extreme riverine flooding, dam failures, or overtopping (or failure) of levees.

While FIRMs consider storm-induced erosion associated with a single 100-year flood, they do not capture erosion potential at a site. They also do not consider the potential for waterborne debris or subsidence.

Regardless of their limitations, flood maps are valuable tools; however, additional data should be considered when evaluating the hazard. Evaluating hazards associated with flood maps is just one component of effectively mitigating the hazard posed by floodwaters.

NOTE

A Flood Insurance Study (FIS) is an examination, evaluation, and determination of flood hazards and, if appropriate, the corresponding water-surface elevations. This information is used to develop FIRMs.

Digital Flood Insurance Rate Maps (DFIRMs) are the current format in which FIRMs are being produced. This new digital format utilizes a geographic information system environment and will replace the existing manually produced FIRMs. This new format provides a more interactive format that will be associated with databases that will allow additional information to be accessed. This information will include the FIS data including the hydrologic and hydraulic models used to produce the study. Additional data such as benchmarks, structure related data and aerial photograph overlays will provide the user with more information in a more expeditious manner.

2.1.4.3 NFIP Flood Zones

NFIP-prepared FIRMs show different flood zones to delineate different floodplain characteristics (see Figure 2-18). The flood zones shown on the FIRMs, and some other designations, are described below. Figure 2-19 shows the relationships of flood zones to each other.

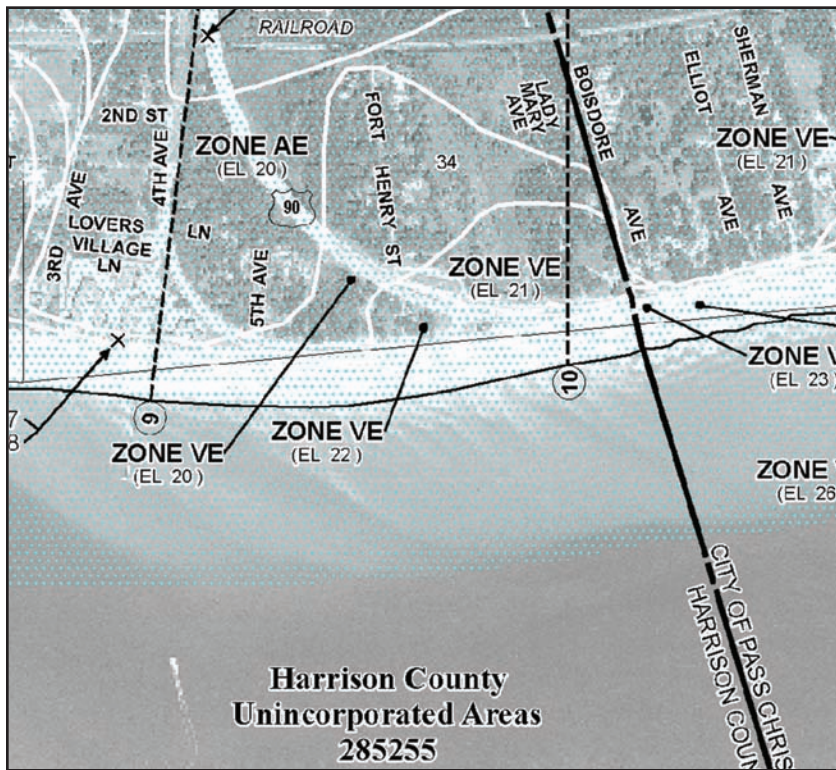

Figure 2-18. Example of a Digital Flood Insurance Rate Map (DFIRM).

NOTE
Advisory Base Flood Elevations (ABFE) are sometimes developed after a specific event. These maps are based on surveyed high-water marks and inundation limits, but not the 500-year flood hazard area. Upon the issuance of a Recovery Advisory, these may be used in lieu of existing BFEs.

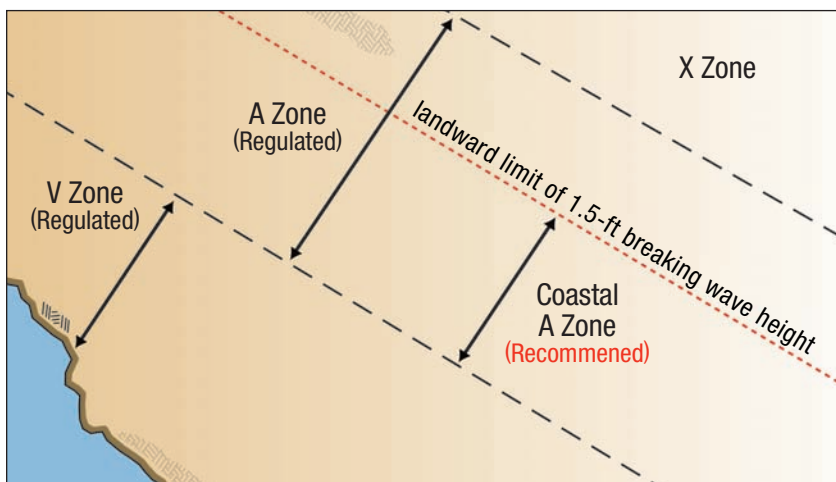

Figure 2-19. Coastal flood hazard areas.

NOTE
Current editions of the building codes refer to ASCE 7-05 and ASCE 24-05; both design standards include requirements for Coastal A Zones (see Chapter 3 of this guide).

V Zones. Also known as coastal high-hazard areas, these SFHAs are subject to high-velocity wave action. V Zones are relatively narrow areas along open coastlines and some large lake shores that are subject to high-velocity wave action from storms or seismic sources. V Zones extend from offshore to the inland limit of a primary frontal dune or to an inland limit where the predicted height of breaking waves drops below 3 feet or a wave run-up depth of less than 3 feet.

VE and V1-V30. Also called numbered V Zones, these designations are used for SFHAs where engineering analyses have produced detailed flood elevations and boundaries for the base flood (1-percent-annual-chance flood). BFEs are provided.

A Zones. Also called unnumbered A Zones or approximate A Zones, this designation is used for SFHAs where engineering analyses have not been performed to develop detailed flood elevations. BFEs are not provided. Additional engineering analyses and site-specific assessments usually are required to determine the BFE.

AE Zones or A1-A30 Zones. Also called numbered A Zones, these designations are used for SFHAs where engineering analyses have produced detailed flood elevations and boundaries for the base flood (1-percent-annual-chance flood). BFEs are provided for riverine waterways within these zones. An FIS will include longitudinal profiles showing water surface elevations for different frequency flood events.

AO and AH Zones. These zones include areas of shallow flooding and are generally shown where the flood depth averages from 1 to 3 feet, a clearly defined channel does not exist, the path of flooding is unpredictable, and velocity flow may be evident. These zones are characterized by ponding or sheetflow. BFEs may be provided for AH Zones; flood depths may be specified in AO Zones. In coastal areas, AO Zones are most common on the landward side of dunes.

Coastal A Zones. These zones are not noted on FIRMs; however, they have been noted as being clearly defined zones where breaking waves are between 3 feet and 1.5 feet. The indication of the Limit of Moderate Wave Action (LiMWA) on many of the recent FIRMs is a good indication of the location of a Coastal A Zone. A LiMWA is the approximate landward limit of the 1.5 feet breaking wave. Because Coastal A Zones are not delineated on FIRMs, it is necessary to determine whether the required conditions are likely to occur at a site. The use of Coastal A Zones is either by local adoption or at the discretion of the AHJ.

Shaded X (or B) Zones. These zones show areas of the 500-year flood (0.2 percent-annual-chance flood) or areas protected by flood control levees. These zones are not shown on many NFIP maps; however, their absence does not imply that flooding of this frequency will not occur. With map modernization projects underway, the B Zone designation will not be used after 2010.

Unshaded X (or C) Zones. These zones are all land areas not mapped as flood hazard areas; they are outside of the floodplain that is designated for the purposes of regulating development pursuant to the NFIP. With map modernization projects underway, the C Zone designation will not be used after 2010.

Levee Certification. Special attention should be paid to the FIRM in areas with structures behind a levee. When reviewing areas behind levees, the status of the levee should be considered. The Notes to Users section on the FIRM explains the levee status at the time of map publication. Additional information on the levee certification process is in FEMA Procedure Memorandum No. 43, *Guidelines for Identifying Provisionally Accredited Levees*.

2.2 Wind Hazards: General Design Considerations

Even a well-designed, constructed, and maintained building may be damaged in a wind event stronger than the design wind speed. Most damage occurs because building elements have limited wind resistance due to inadequate design, poor installation, or material deterioration. Although the magnitude and frequency of strong windstorms vary by locale, all buildings should be designed, constructed, and maintained to minimize and resist wind damage.

Numerous examples of best practices pertaining to new and existing buildings are presented in this guide as recommended design and construction guidelines. Incorporating those practices applicable to specific projects will result in greater wind resistance reliability and will therefore decrease expenditures for repair of wind-damaged buildings and provide enhanced protection for occupants.

2.2.1 Primary Storm Types

A variety of windstorm events occurs in coastal areas of the United States. Characteristics of storm types that can affect the site should be considered by the designer. Primary storm types are described below.

Straight-line wind. This wind type is normally generated by thunderstorms. Straight-line wind intensities can be similar to those of a tornado. In contrast to a tornado, which produces winds in a rotating motion, straight-line winds push in one direction. High winds associated with intense low pressure can last for approximately a day at a given location. Although it is more common in some areas, straight-line winds can occur anywhere throughout the United States and its territories.¹

Thunderstorm. Thunderstorms can form rapidly and produce high wind speeds. Approximately 10,000 severe thunderstorms occur in the United States each year, typically in the spring and summer, and they are most common in the Southeast and Midwest. In addition to producing high winds, they often create heavy rain and sometimes spawn tornadoes and hailstorms. Thunderstorms commonly move through an area rapidly, causing high winds for only a few minutes at a given location. They can also stall and become virtually stationary.

Downburst. Also known as a microburst, this is a powerful downdraft associated with a thunderstorm. When the downdraft reaches the ground, it spreads out horizontally and may form one or more horizontal vortex rings around the downdraft. The outflow is typically 6,000 to 12,000 feet across, and the vortex ring may rise 2,000 feet above the ground. The life cycle of a downburst is usually 15 to 20 minutes. Observations suggest that approximately 5 percent of all thunderstorms produce downbursts, which can result in significant damage in localized areas. It is not uncommon for the untrained observer to mistake downburst damage as tornado damage.

Nor easter (northeaster). A nor easter is a cyclonic storm occurring off the east coast of North America. These weather events (typically occurring in the winter season) are notorious for producing heavy snow, rain, high waves, and wind. A nor easter gets its name from the continuously strong northeasterly winds blowing in from the ocean ahead of the storm and over the coastal areas. These storms may last for several days.

¹U.S. territories include American Samoa, Guam, Northern Mariana Islands, Puerto Rico, and the U.S. Virgin Islands. ASCE 7-05 provides basic wind speed criteria for all but Northern Mariana Islands.

Tornado. Tornadoes are violently rotating columns of air extending from the base of a thunderstorm to the ground. Although the wind speed at a given building site might not be great, a building on the periphery could still be impacted by many large pieces of windborne debris. Tornadoes are responsible for the greatest number of the nation's wind-related deaths each year. However, tornado frequency, occurrence, and wind speeds **are not** considered by the wind maps of the IBC, IRC, and ASCE used to identify the basic (design) wind speed at a particular site.

Buildings that are well-designed, well-constructed, and well-maintained should have little if any damage from weak tornadoes, except for window breakage. However, weak tornadoes often cause building envelope damage because many buildings have inherent vulnerabilities to wind and windborne debris. Most buildings experience significant damage if they are in the path of a strong or violent tornado because they typically are not designed for this storm type. As of February 2007, tornadoes are now classified by the Enhanced Fujita Scale shown in Table 2-1.

NOTE
 ASCE 7-05 defines "Special Wind Region" as an area where the basic wind speed shall be increased where records or experience indicate that the wind speeds are higher than normal. These regions consist of mountainous terrain, gorges, and other special topographic features.

Table 2-1. Enhanced Fujita Scale.

EF-SCALE	DAMAGE LEVEL	WIND SPEED (3-SEC GUST)	TYPE OF DAMAGE DONE
EF0	Light	65–85 mph	Peels surface off of some roofs; some damage to gutters or siding; branches broken off trees; shallow-rooted trees pushed over.
EF1	Moderate	86–110 mph	Roofs severely stripped; mobile homes overturned or badly damaged; loss of exterior doors; windows and other glass broken.
EF2	Considerable	111–135 mph	Roofs torn off well-constructed houses; foundations of frame homes shifted; mobile homes completely destroyed; large trees snapped or uprooted; light-object missiles generated; cars lifted off ground.
EF3	Severe	136–165 mph	Entire stories of well-constructed houses destroyed; severe damage to large buildings such as shopping malls; trains overturned; trees debarked; heavy cars lifted off the ground and thrown; structures with weak foundations blown away some distance.
EF4	Devastating	166–200 mph	Well-constructed houses and entire frame houses completely leveled; cars thrown and small missiles generated.
EF5	Incredible	>200 mph	Strong frame houses leveled off foundations and swept away; automobile-sized missiles fly through the air in excess of 100 yards; high-rise buildings have significant structural deformation; incredible phenomena occurs.

Source: National Oceanic and Atmospheric Administration

Hurricane. A hurricane is a system of spiraling winds converging with increasing speed toward the storm's center (the eye of the hurricane). Hurricanes form over warm ocean waters. The diameter of the storm varies from 50 miles to 600 miles. A hurricane's forward movement (translational speed) can vary between approximately 5 mph to more than 25 mph. Besides being capable of delivering extremely strong winds for several hours and moderately strong winds for a day or more, many hurricanes also bring heavy rainfall. Hurricanes can also spawn tornadoes.

Of all the storm types, hurricanes have the greatest potential for devastating a large geographical area and, hence, affecting the greatest number of people. The terms hurricane, cyclone, and typhoon describe the same type of storm. The term used depends on the region of the world where the storm occurs. Figure 2-20 shows hurricane-prone regions of the United States. Table 2-2 presents the Saffir-Simpson scale used to classify hurricane intensity. The table shows wind speeds for the different categories as both sustained winds and gust speeds. Hurricane frequency, occurrence, and wind speeds **are** considered by the IBC, IRC, and ASCE when producing wind maps that identify the basic (design) wind speed at a given site. Additional information is provided in Section 2.2.1.3.

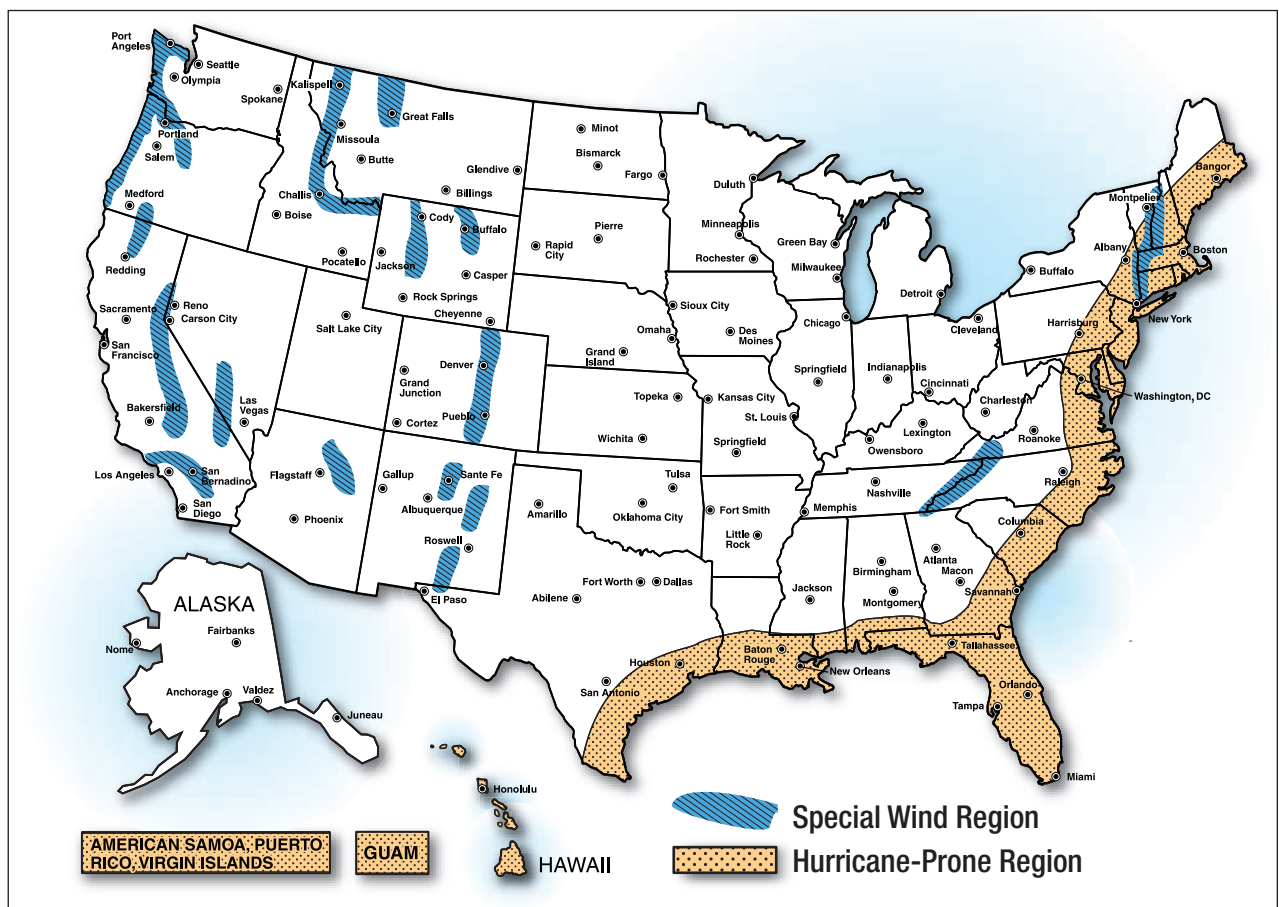

Figure 2-20. Hurricane-prone regions and special wind regions. (Source: Adapted from ASCE 7-05)

Table 2-2. Saffir-Simpson Hurricane Scale

Strength	Sustained Wind Speed (mph) 1 minute sustained wind over water	Gust Wind Speed (mph) 3 second gust over open water	Gust Wind Speed (mph) 3 second gust over open ground	Pressure (millibar)	Description
Cat 1	74–95	91–116	82–108	>979	Storm surge 4 to 5 feet above normal; no real building damage; unanchored mobile homes damaged.
Cat 2	96–110	117–140	109–130	965–979	Storm surge 6 to 8 feet above normal; some roofing, door, and window damage; considerable damage to mobile homes.
Cat 3	111–130	141–165	131–156	945–964	Storm surge 9 to 12 feet above normal; some structural damage to small residences and utility buildings with minor curtain wall damage; mobile homes destroyed.
Cat 4	131–155	166–195	157–191	920–944	More extensive curtainwall failures with some complete roof structure failures on small residences; complete destruction of mobile homes.
Cat 5	>155	>195	>191	<920	Complete roof failure on many residences and industrial buildings; some complete building failures with small utility buildings blown over or away; complete destruction of mobile homes.

NOTE

The Saffir-Simpson Hurricane Scale categorizes hurricanes based on sustained wind speeds. Storm surge is not always correlated with the category because other factors influence surge elevations, notably forward speed of the storm, tide cycle, offshore bathymetry, and land topography.

2.2.1.1 Windborne Debris

During any large wind event heavy objects can become airborne. These objects pose significant hazards to the surrounding buildings. Design criteria in the current model building codes take these hazards into account by requiring protection systems for glazed openings developed to resist small (rocks, roofing material, and small branches) and large (trees, signs, and posts) impacts from windborne debris (commonly referred to as missiles). These objects typically impact all portions of a building and cause damage to doors, glazing, exterior siding, and roofs. Construction methods that do not account for missile impacts can result in a breach of the building envelope and subsequently cause additional damage to the structure due to wind loading. Protection of glazing from windborne debris impact is required based upon your proximity to the coast and the basic wind speed at a site. Additional information is provided in Chapter 10.

2.2.1.2 Rainfall Penetration

High winds impact buildings in many ways. In addition to loading from the wind and windborne debris, when they are coupled with rain events, significant water intrusion problems can occur. Portions of the building envelope that have been designed to shed rain may be compromised by wind-driven rain.

2.2.1.3 Wind/Building Interactions

When wind interacts with a building, both positive and negative pressures occur simultaneously (see Figure 2-21). To prevent wind-induced building failure, buildings must have sufficient strength to resist the applied loads from these pressures. Loads exerted on the building envelope are transferred to the structural system, where they in turn must be transferred through the foundation into the ground, or building damage may result. Chapter 5 of this guide has a detailed discussion of load paths and the importance of load path continuity. The magnitude of the pressure is a function of several primary factors: exposure, basic wind speed, topography, building height, building shape, and internal pressure classification.

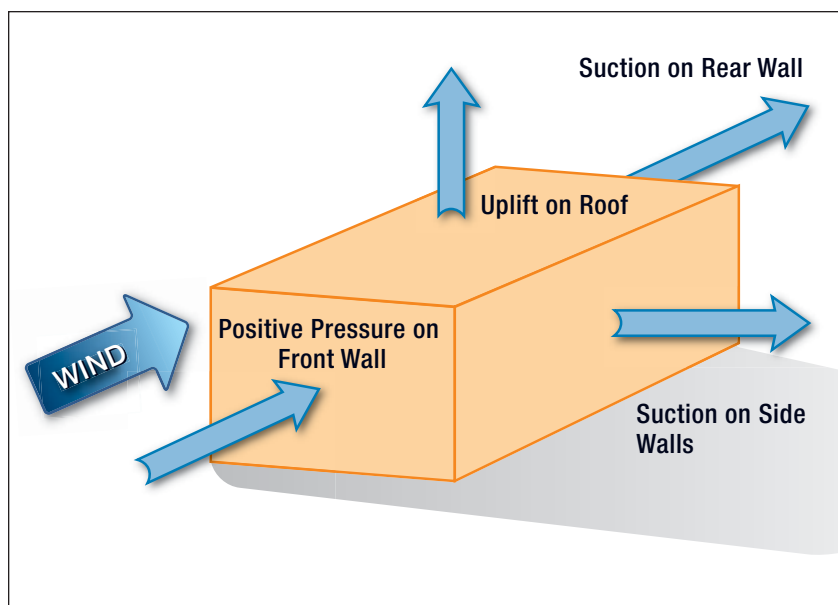

Figure 2-21.
Wind-induced pressures on a building. (Source: FEMA 543)

NOTE

For information on exposure, see ASCE 7-05, Chapter 6 Commentary, which includes aerial photographs of the different terrain conditions associated with Exposures B, C, and D.

Basic wind speed. ASCE 7-05 specifies the basic (design) wind speed for determining design wind loads at a building site. The basic wind speed is mapped for the continental U.S. and provided for other islands and U.S. territories at 33 feet above grade in Exposure C (flat open terrain). If a building is located in an Exposure B or D area, rather than a C area, an adjustment for the actual exposure is made in the ASCE 7-05 calculation procedure when wind pressures are calculated.

Since the 1995 edition of ASCE 7, the basic wind speed measurement has been a 3-second gust speed. Before 1995, the basic wind speed was a fastest-mile speed (i.e., the speed averaged over the time required for a mile-long column of air to pass a fixed point)². Most of the United States has a basic wind speed of 90 mph³, but much higher speeds occur in Alaska and in hurricane-prone regions. The highest basic wind speed specified on the ASCE 7-05 map 170 mph is in Guam. Hurricane-prone regions are defined in ASCE 7-05 to be the Atlantic and Gulf coastal areas where the basic wind speed is greater than 90 mph, Hawaii, and the U.S. territories in the Caribbean and South Pacific (see Figure 2-20).

Basic Wind Speed. The design values used to begin the wind load calculations using ASCE 7-05. This wind speed value is measured at a height of 33 feet (10 meters) above grade and for an Exposure C. ASCE 7-05 requires that the building be designed to sustain this basic wind speed from any direction.

3-second gust. The measurement of wind speed averaged over a 3 second period. The short duration of the average is why it is referred to as a gust.

Fastest mile. The average speed for a 1-mile-long column of air to pass an anemometer. (Now an obsolete term and no longer used by the National Weather Service.)

The Saffir-Simpson Hurricane Scale (Table 2-2) measures sustained winds that are averaged over 1 minute. Therefore, these wind speeds are not equivalent to fastest mile or 3-second gust wind speeds used by the codes. The measurements are taken over open water. To convert this information into a 3-second gust, a conversion must be made to the sustained winds over land and then further converted to the 3-second gust using the Durst curve (see ASCE 7-05). ASCE 7-05, Commentary C6, explains the conversion of sustained wind over water to sustained wind over land.

In the formulas used to determine wind pressures, the basic wind speed is squared. Therefore, as the wind speed increases, the pressures acting on a building are exponentially increased, as shown in Figure 2-22. Figure 2-22 also illustrates the relative difference in pressures exerted on the Main Wind Force Resisting System (MWFRS) and the components and cladding (C&C) elements of buildings. Higher winds can produce vortices creating very high local pressures on C&C. These pressures on roofing, roof sheathing and sidings are localized and much greater than that on the main framing members. Drawings should provide specific detailing and fastening of roofing, roof sheathing, and siding in these areas.

Exposure. Terrain characteristics (i.e., ground roughness and surface irregularities in the vicinity of a building) influence wind loading. ASCE 7-05 defines three exposure categories: Exposures B, C, and D, with Exposure B being the roughest terrain category and Exposure D being the smoothest.

²Gust speeds are about 15 mph to 20 mph higher than fastest-mile speeds (e.g., a 90 mph peak basic wind speed is equivalent to a 76 mph fastest-mile wind speed). International Building Code, Chapter 16, has a table of equivalent basic wind speeds.

³Unless otherwise noted, wind speeds in this guide are presented as 3-second gust wind speeds with exposure C at 33 feet above grade.

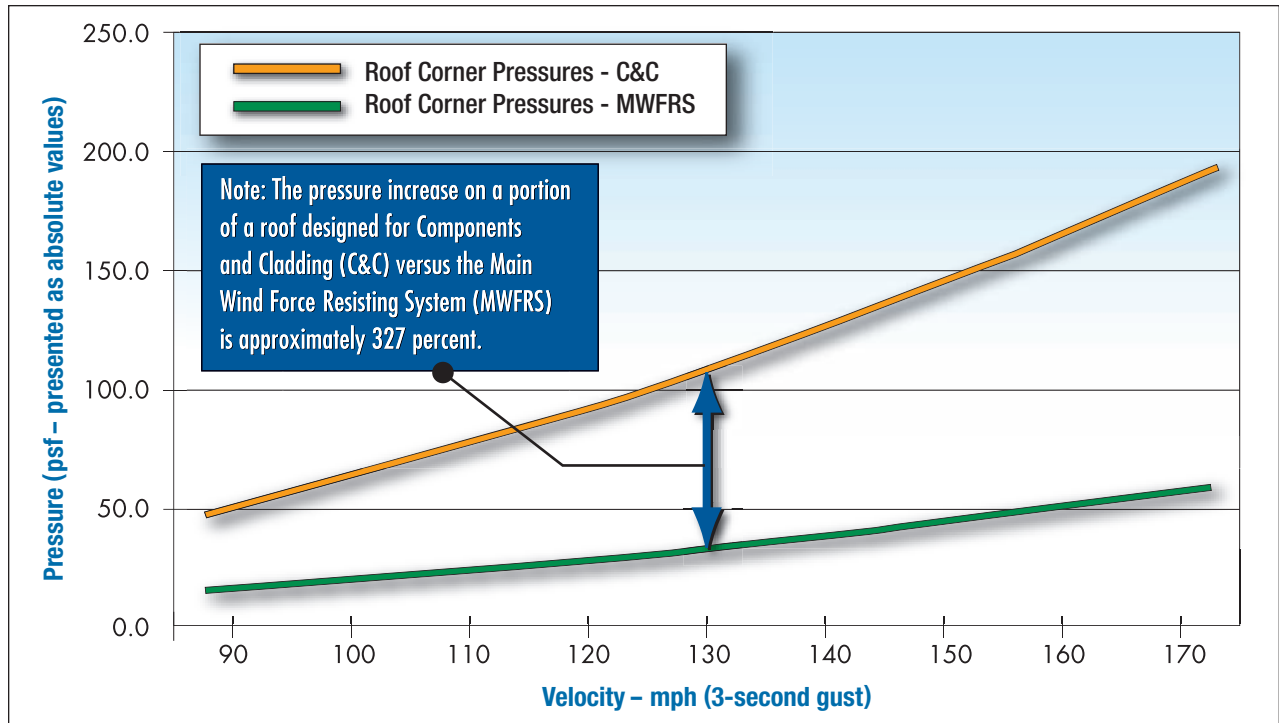

Figure 2-22.

Wind pressure as a function of wind speed. (Source: FEMA 543)

Exposure B includes urban, suburban, and wooded areas. Exposure C includes flat, open terrain with scattered obstructions and areas adjacent to water surfaces in hurricane-prone regions (which are defined above under basic wind speed). Exposure D includes areas adjacent to water surfaces outside hurricane-prone regions, mud flats, salt flats, and unbroken ice. Because of the wave conditions generated by hurricanes, areas adjacent to water surfaces in hurricane-prone regions are considered to be Exposure C rather than the smoother Exposure D. The smoother the terrain, the greater the wind pressure; therefore, buildings in Exposure C areas would receive higher wind loads than those in Exposure B areas, at the same basic wind speed.

Topography. Abrupt changes in topography, such as isolated hills, ridges, and escarpments, cause wind to speed up. A building located near a ridge would receive higher wind pressures than a building located on relatively flat land; in some cases, the wind pressures may be twice those on flat areas. ASCE 7-05 has a procedure to account for topographic influences.

Building height. Wind speed at a particular site increases with height above ground. Taller buildings are exposed to higher wind speeds and greater wind pressures. ASCE 7-05 contains a procedure to account for building height during the calculation of wind pressures.

For buildings of lower heights (such as those found in coastal areas), elevating or raising the building to account for flood hazards will increase the wind pressures acting on the building. However, this increase is relatively small. Tables 2-3 and 2-4 provide wind pressure information for five locations on a hypothetical building located on a site with a basic wind speed of 120 mph. The wind pressures were determined using the prescriptive tables from ASCE 7-05 for low-rise buildings (ASCE 7-05, Figures 6-2 and 6-3).

Table 2-3. Wind Pressure Example for Exposure B

Mean roof height above grade in Exp B	MWFRS		C&C		
	Wall	Roof	Wall Zone 5	Roof Zone 1	Roof Zone 3
(feet)	(psf)*	(psf)	(psf)	(psf)	(psf)
15	21.10	-19.10	-34.70	-23.70	-61.00
20	21.10	-19.10	-34.70	-23.70	-61.00
25	21.10	-19.10	-34.70	-23.70	-61.00
30	21.10	-19.10	-34.70	-23.70	-61.00
35	22.16	-20.06	-36.44	-24.89	-64.05
40	23.00	-20.82	-37.82	-25.83	-66.49
45	23.63	-21.39	-38.64	-26.54	-68.32

Table Notes (applicable for each table)

1. Wind pressures calculated for a square building, approximately 20 ft by 20 ft
2. Roof slope = 20 degrees (assumed)
3. Effective wind area = 10 sf (for C&C wind pressures)
4. The highest elevation provided is for a mean roof height of 45 feet above grade.
The tables were ended at this height as that is a common zoning limit used for the height of residential structures in coastal areas.

* (psf) pounds per square foot

Specifically, for homes sited where the terrain surrounding the building is considered Exposure B (see ASCE 7-05), Table 2-3 shows there is no change to the wind pressures if the mean roof height is increased from an elevation 15 feet above ground to 30 feet above ground. In general, as the building height increases in any 5-foot increment (from 30 feet to 35 feet, from 35 feet to 40 feet, or from 40 feet to 45 feet), the increase in pressures is approximately 5 percent. If the elevation increase was a change of 10 feet, the increase in pressures is approximately 8 percent, while an increase in 30 feet would result in a change in pressures of approximately 10 percent. Considering that even the largest pressure increase associated with a 30-foot elevation change results only in an increase of 7 psf, the impact to the building design and cost would be minimal for connectors or members to withstand these new wind pressures.

Similarly, Table 2-4 provides the same comparison for a building sited in Exposure C. The primary difference is that wind pressures will begin to increase as the mean roof height is increased from 15 feet to 20 feet (approximately 6 percent). However, after this initial increase, the increase in pressures for elevation changes of 5 feet and 10 feet are less than those in Table 2-3 for Exposure B conditions, approximately 3.5 percent and 6 percent, respectively. Although the total increase in wind pressure for some building components may increase 20 percent if the building elevation is increased 30 feet, this is not a probable scenario. In most cases, the building may be elevated 10 or 15 feet higher than it was originally constructed. The increase in wind pressures from 15 to 30 feet above grade would only be 13.5 percent. Again, as connectors and large members would be required to carry the loads for the basic wind speed at the site, an increase in pressure of 5 to 12 psf for select building components would have minimal impact on the building design or cost because connectors and other fasteners would have been required for the building at this site regardless of height.

These tables also highlight the differences between wind loads in Exposure B and C areas. If a site is improperly classified as Exposure B, the building may be underdesigned by as much as 30 to 40 percent (based on comparative C&C loads.)

Table 2-4. Wind Pressure Example for Exposure C

Mean roof height above grade in Exp C	MWFRS		C&C		
	Wall	Roof	Wall Zone 5	Roof Zone 1	Roof Zone 3
(feet)	(psf)*	(psf)	(psf)	(psf)	(psf)
15	25.53	-23.11	-41.90	-28.68	-73.81
20	27.22	-24.64	-44.76	-30.57	-78.69
25	28.49	-25.79	-46.85	-32.00	-82.35
30	29.54	-26.74	-48.58	-33.18	-85.40
35	30.60	-27.70	-50.32	-34.37	-88.45
40	31.44	-28.46	-51.70	-35.31	-90.80
45	32.28	-29.22	-53.09	-36.26	-93.33

Table Notes (applicable for each table)

1. Wind pressures calculated for a square building, approximately 20 ft by 20 ft
2. Roof slope = 20 degrees (assumed)
3. Effective wind area = 10 sf (for C&C wind pressures)
4. The highest elevation provided is for a mean roof height of 45 feet above grade.
The tables were ended at this height as that is a common zoning limit used for the height of residential structures in coastal areas.

* (psf) pounds per square foot

Building shape. As wind flows over and around a building, the resultant pressures acting on it are a function of the building shape and its orientation to the wind. Exterior walls typically have lower loads than the roof. The ends (edges) of walls have higher suction loads than the portion of wall between the ends. However, when the wall is loaded with positive pressure, the entire wall is uniformly loaded. Figure 2-23 shows these aerodynamic influences. The negative values shown on Figure 2-24 indicate suction pressure acting upward from the roof surface and outward from the wall surface. Positive values indicate positive pressure acting inward on the wall surface. Positive coefficients represent a positive (inward acting) pressure, and negative coefficients represent negative (outward acting [suction]) pressure. Building irregularities, such as entryways, corners, bay window projections, stair towers projecting from main walls, dormers, and chimneys can all cause localized turbulence. Turbulence causes wind to speed up, which increases the wind loads in the vicinity of the building irregularity. Simply stated, it can be assumed that at locations where building geometry changes, pressures will increase. These areas may include wall corners, roof edges, corners, and overhangs.

Internal pressure (building pressurization/depressurization). The building portion that keeps the elements away from building occupants is typically referred to as the building envelope. Openings through the building envelope, in combination with wind interacting with a building, can cause either an increase in the pressure within the building (i.e., positive internal pressure) or a decrease in the pressure (i.e., negative internal pressure). Gaps or disconnects in the building envelope typically occur around openings such as doors and window frames, and by air infiltration through walls that are not completely airtight. A door or window left open, or glazing that is broken during a storm, can greatly influence the magnitude of the internal pressure and may expose the building to wind forces it was not designed to resist.

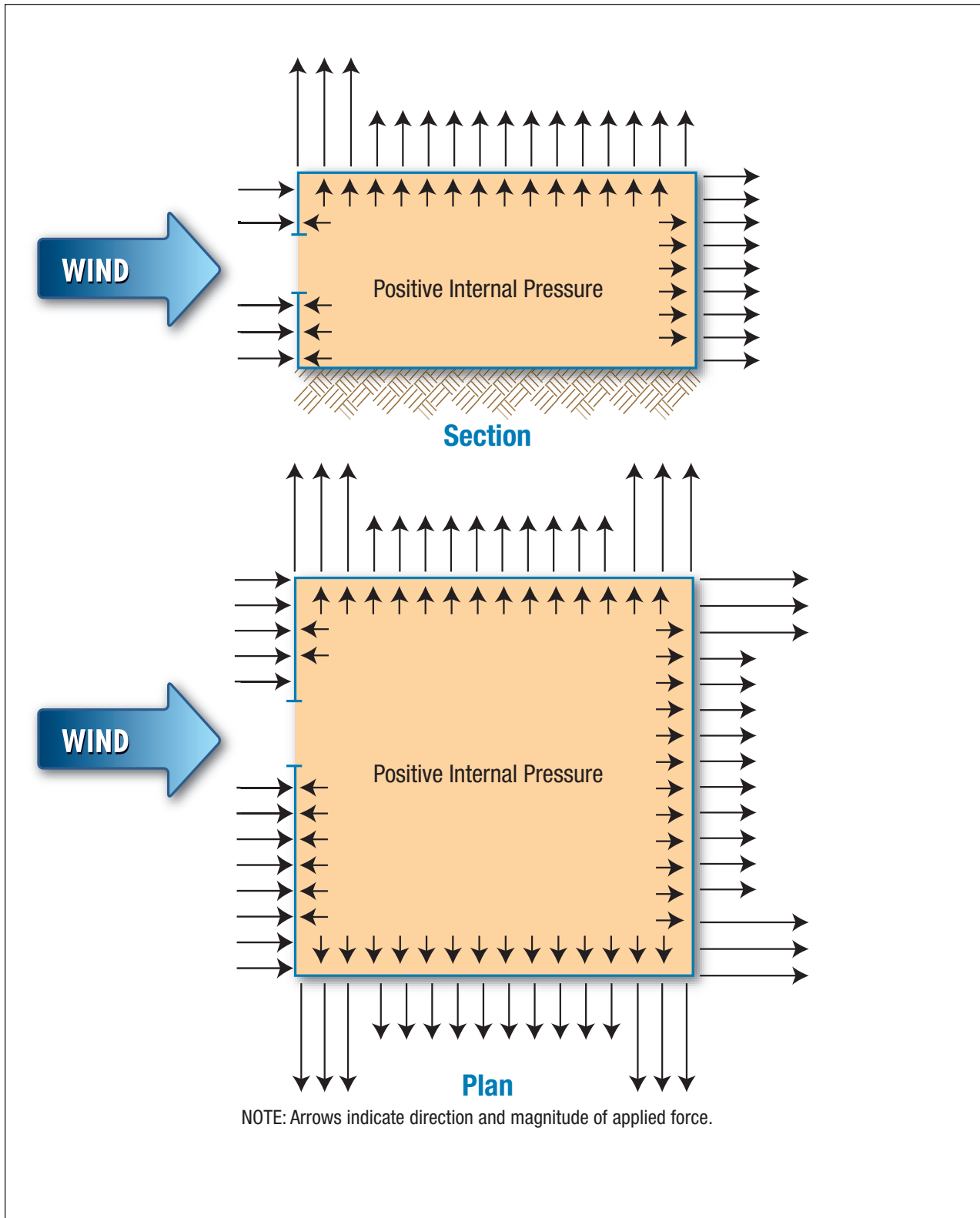

Figure 2-23. Internal pressure condition when the dominant opening is in the windward wall. (Source: FEMA 543)

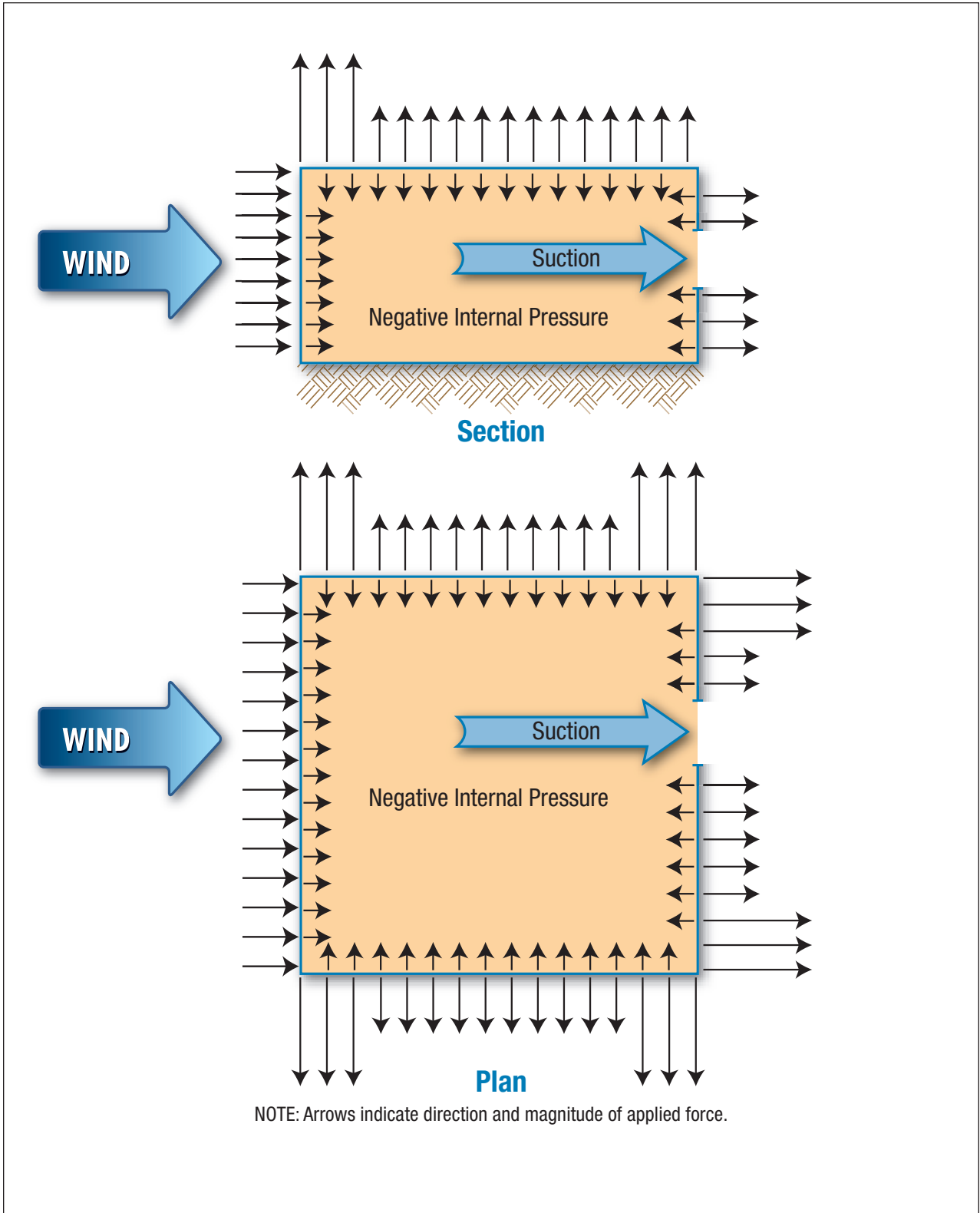

Figure 2-24. Internal pressure condition when the dominant opening is in the leeward wall. (Source: FEMA 543)

Wind striking exterior walls exerts a positive pressure on the wall, which forces air through unprotected openings and into the interior of the building. At the same time that the windward wall is receiving positive pressure, the side and rear walls are experiencing negative (suction) pressure from winds moving around the building. This is in part due to the lack of high-pressure air on the outside of the rear wall. As more air is forced into the building through the unprotected openings, the building begins to bulge or become pressurized. The building will continue to pressurize as the air finds areas of lower pressure and escapes on the rear (leeward) side of the building. Unprotected openings can be breached on the leeward side (opposite the wind) of buildings due to negative pressure (suction). This can cause the opposite effect, and a structure may collapse due to a lack of internal air pressure.

When a building is pressurized, the internal pressure pushes up on the roof. This push from below the roof is combined with suction on the roof from above, resulting in an increased upward wind pressure on the roof. The internal pressure also pushes on the side and rear walls. This outward push is combined with the suction on the exterior side of these walls (see Figures 2-25 and 2-26). The breaching of a small window can be sufficient to cause full pressurization of the facility's interior. When a building becomes fully pressurized (e.g., due to window breakage or soffit failure), the loads applied to the exterior walls and roof are significantly increased. The rapid build up of internal pressure can also blow down interior partitions and blow suspended ceiling panels out of their supporting grid.

When a building is depressurized, the internal pressure pulls the roof down, thus reducing the uplift exerted on the roof. The decreased internal pressure also pulls inward on the windward wall, which increases the wind loading on that wall.

The ASCE 7-05 wind design procedure accounts for the influence of internal pressure on the wall and roof loads, and it provides positive and negative internal pressure coefficients for use in load calculations. Buildings that are designed to accommodate full pressurization are referred to as partially enclosed buildings. According to the criteria in ASCE 7-05, the presence of openings (doors, windows, and vents) on exterior walls and surfaces of the building determine whether a building can be considered enclosed, partially enclosed or open. Once the appropriate designation has been selected, the building is designed for the pressures associated with the designation. Typically, buildings that are intended to experience only limited internal pressurization are referred to as enclosed buildings. Buildings that do not experience internal pressurization are referred to as open buildings (such as covered walkways and most parking garages). It should be noted, that the 2006 IBC and IRC limit the use of partially enclosed buildings without opening protection in hurricane-prone regions.



Figure 2-25.

OCEAN SPRINGS, MISSISSIPPI: Apartment complex severely damaged by wind. Although wind speeds were less than current code-specified values, widespread severe damage occurred at this development, a result of poor construction quality. (Source: FEMA 549)



Figure 2-26.

GULF SHORES, ALABAMA: Partition walls destroyed by interior pressurization due to window damage. (Source: FEMA 489)

2.3 Other Hazards

During any storm event there exists the potential for other types of hazards. These hazards can be caused either by the storm event or be totally independent of it. In either case, their potential impacts should be considered in the design of the structure.

NOTE

Additional information on publications from the National Earthquake Hazard Reduction Program (NEHRP) publications are available at <http://www.fema.gov/plan/prevent/index.shtm>

Earthquake and seismic events. Seismic events can occur on both the west and east coasts. Such events can cause liquefaction (soil failures), surface fault ruptures, slope failures, or spur tsunamis. Local officials in coastal areas with potential for seismic events should consider these possibilities when reviewing building plans. While most building officials in seismic areas are aware of the building considerations necessary, coastal areas present particular challenges. The need to elevate buildings to prevent waves and infiltration from floodwaters and damage from floodborne debris adds challenges to stabilize them from the movement induced by an earthquake. Model building codes and guidance from FEMA through the National Earthquake Hazard Reduction Program (NEHRP) provide code requirements and best practices in regions with seismic activity. Additional guidance on the design of residential buildings in seismic areas is provided in FEMA 232, *Homebuilders Guide to Earthquake-Resistant Design and Construction*.

Tsunamis. Long-period water waves generated by undersea shallow-focus earthquakes or by tectonic plate movements, landslides, or volcanic activity are referred to as tsunamis. Tsunamis can travel great distances in deep water and can grow quite large when they reach shallow coastal areas. Designing for or resisting wave loads for tsunamis may be difficult and expensive.

Indoor air quality. After a storm event, mold can grow quickly and present major human health hazards. Mold and mildew are present everywhere but need excessive moisture and a food source to become problematic. Long-term power outages after storms and a lack of airflow from non-operating HVAC systems prevent moist areas inside houses from drying out. The possibility for mold propagation should be considered as a potential hazard when residential structures are rebuilt after storm events. If mold is suspected, air quality experts should be contacted to ensure that proper mitigation techniques are used. Information is available at <http://www.epa.gov/mold/moldresources.html>. Additional information can be found in FEMA 549, *Mitigation Assessment Team Report: Hurricane Katrina in the Gulf Coast, Building Performance Observations, Recommendations, and Technical Guidance*.

Levee failure. The United States has thousands of miles of levees. Levees can fail in three ways: a breach or break in the levee, water seeping underneath the levee and erupting on the other side (called a boil), and overtopping or floodwaters exceeding the height of the levee. Each of these failures is usually triggered by excessive rains or storm surges. Residential structures protected by levees should be evaluated for their susceptibility to levee failure because most areas have been mapped (to show flood zones), assuming the levees remain intact and functional. Levee failures can often be worse than standard storm surge or rain flooding due to the water being trapped or contained. An example of the devastating effects of levee failure is shown in Figure 2-27.



Figure 2-27.
NEW ORLEANS, LOUISIANA: Neighborhood with homes flooded and cars covered. In the background is a breached levee with water entering the area. (Source: FEMA 549)

Investigating Regulatory Requirements

States and communities enforce regulatory requirements that determine where and how buildings may be sited, designed, and constructed. These requirements include those associated with programs established by federal and state statutes, building codes and standards, and locally adopted floodplain management and land use ordinances and laws.

NOTE

Unless otherwise noted, citations for the I-Codes in this guide refer to the 2006 editions.

This chapter begins with a discussion of the NFIP. The remaining sections explain how to meet the minimum requirements through enforcement of the 2006 editions of the IBC and IRC, standards ASCE 7-05 and 24-05, and other regulatory documents. The chapter outlines minimum flood- and wind-design requirements for hazard-resistant construction. Later chapters detail these requirements and provide examples of best practices to meet or exceed these requirements.

3.1 Floodplain Management Requirements and Building Codes

The NFIP is the basis for the minimum requirements included in model building codes and standards for flood-resistant design and construction methods used to withstand flood damage. FEMA manages the NFIP, which is intended to reduce the loss of life and damage caused by floods and flood-related hazards. The original authorizing legislation for the NFIP is the National Flood Insurance Act of 1968 (42 U.S.C. 4001 et seq.). In that act, the U.S. Congress expressly found that a program of flood insurance can promote the public interest by encouraging sound land use by minimizing exposure of property to flood losses...

NOTE

This guide does not cover manufactured housing. For NFIP requirements concerning manufactured housing, see § 60.3 of the regulations, and FEMA 85, *Manufactured Home Installation in Flood Hazard Areas*. Other relevant reference materials include NFPA 225, *Model Manufactured Home Installation Standard*, 2005 Edition and publications produced by U.S. Department of Housing and Urban Development.

The most convincing evidence of the effectiveness of the NFIP minimum requirements is found in flood insurance claim payment statistics. Buildings that pre-date the NFIP requirements were generally not constructed to resist flood damage and buildings that post-date the NFIP are designed to resist flood damage. The NFIP aggregate loss data indicates that buildings meeting the minimum requirements experience 80-percent less flood damage than buildings that pre-date the NFIP. Ample evidence suggests that buildings designed to exceed the minimum requirements are even less likely to sustain damage.

3.1.1 Overview of the National Flood Insurance Program

The NFIP is based upon the premise that the Federal government will make flood insurance available in communities that adopt and enforce floodplain management regulations that meet or exceed the minimum NFIP requirements. When decisions result in development within flood hazard areas, application of the criteria of the NFIP are intended to minimize exposure and flood-related damage. State and local governments are responsible for applying the provisions of the NFIP through the regulatory permitting processes. At the Federal level, the NFIP is managed by FEMA and has three main functions:

- Requires communities to adopt floodplain management regulations to minimize flood damages to new buildings and those buildings that undergo substantial improvements or that have been substantially damaged.
- Provides floodplain management criteria for development, which establish the minimum requirements to be applied to development within mapped flood hazard areas. The intent is to recognize hazards in the entire land development process.
- Offers flood insurance, which provides some financial protection for property owners to cover costs associated with flood-related damage to buildings and contents.

The NFIP provisions guide development to lower-risk areas by requiring compliance with performance measures to minimize exposure of new buildings and buildings that undergo major renovation or expansion (called *substantial improvement* or *repair of substantial damage*). This achieves the long-term objective of building disaster-resistant communities.

Substantial Improvement. Any repair, reconstruction, rehabilitation, addition, or improvement of a building or structure, the cost of which equals or exceeds 50 percent of the market value of the structure before the improvement or repair is started. If the structure has sustained substantial damage, any repairs are considered substantial improvements regardless of the actual repair work performed. The term does not, however, include either:

- Any project for improvement of a building required to correct existing health, sanitary, or safety code violations identified by the building official and that are the minimum necessary to assure safe living conditions.
- Any alteration of a historic structure, provided that the alteration will not preclude the structure's continued designation as a historic structure.

Substantial Damage. Damage of any origin sustained by a structure whereby the cost of restoring the structure to its before-damaged condition would equal or exceed 50 percent of the market value of the structure before the damage occurred.

3.1.2 Summary of the NFIP Minimum Requirements

Performance requirements of the NFIP are set forth in Federal Regulation 44, Code of Federal Regulations (CFR), Part 60. The requirements apply to all types of development, which the NFIP broadly defines to include buildings and structures, site work, roads and bridges, and other related activities. Residential buildings must be designed and constructed to resist flood damage, and that resistance is primarily achieved through elevation. Additional specific requirements apply to existing developments—especially existing buildings. Existing buildings that are proposed for substantial improvement, including restoration following substantial damage, are subject to the regulations.

Although NFIP regulations focus primarily on how to build structures, one of the long-term objectives of the program is to guide development to less hazardous locations. Preparing flood hazard maps and making the information available to the public is a fundamental step in satisfying that objective. With that information, interested parties can make informed decisions about where to build, how to use site design to minimize exposure to flooding, and how to design buildings that will resist flood damage.

Community floodplain management ordinances and laws must include requirements concerning the following types of buildings in the SFHA, including those in both A Zones and V Zones: newly constructed buildings, substantially damaged buildings, and substantially improved buildings. Additional requirements must apply to new subdivisions and other development within the SFHA.

Recognizing the greater hazard posed by breaking waves of 3 feet high or higher, FEMA has established the following minimum NFIP regulatory requirements for newly constructed, substantially damaged, and substantially improved buildings located in a V Zone. These requirements are more stringent than the minimum requirements for A Zone buildings:

- Only open-foundation types are allowed.
- The structure or building must be elevated such that the lowest horizontal structural member is constructed at or above the BFE.
- Buildings must be designed and constructed to resist simultaneous wind and flood loads.
- Building designs must be certified by an engineer.

NOTE

Communities participating in the NFIP are encouraged to adopt and enforce floodplain management ordinances or laws that include requirements more stringent than the minimum requirements of NFIP regulations. For example, approximately 60 percent of NFIP participating communities require that buildings be elevated above, rather than simply to, the BFE. The additional elevation required is referred to as freeboard. (See note box on page 2-15 and Section 4.3). See Chapter 6 for the application of freeboard into foundation design.

NOTE

“Reasonably safe from flooding” is defined as a situation in which base flood waters will not inundate the land or damage existing or proposed structures. This would include any subsurface waters related to the base flood.

The location of a building in relation to the A Zone/V Zone boundary on a FIRM can affect the building design. A building or other structure that has any portion of its foundation in a V Zone must be built to comply with V Zone requirements. For best practices, these V Zone requirements should be considered for adoption within Coastal A Zones in order to improve building performance. The subsections below summarize the minimum NFIP regulatory requirements and provide detailed information on V, A, and Coastal A Zone requirements.

3.1.3 Minimum Requirements for All Buildings in All SFHAs

The minimum floodplain management requirements apply to all SFHAs located in communities participating in the NFIP. The requirements affect buildings, subdivisions, and other new development; new and replacement water supply systems; and new and replacement sanitary sewage systems. Below is a summary of some important aspects of 44 CFR Part 60.3, as presented in the Code:

NOTE

In addition to the floodplain management requirements discussed in this guide, NFIP regulations include requirements specific to floodplains along rivers and streams. Because this guide focuses on the construction of residential buildings in coastal areas, it does not provide significant detail on these additional requirements. For more information about these requirements, see FEMA 259, *Engineering Principles and Practices for Retrofitting Floodprone Buildings*, 2001 Edition.

Site Design

The NFIP's broad performance requirements for site work in flood hazard areas are shown below.

- Building sites shall be reasonably safe from flooding.
- Adequate site drainage shall be provided to reduce exposure to flooding.
- New and replacement sanitary sewage systems shall be designed to minimize or eliminate infiltration of floodwaters into the systems, as well as discharges from the systems into floodwaters.
- Development in floodways shall be prohibited, unless engineering analyses show that there will be no increases in flood levels.

General Performance Requirements

The NFIP's broad performance requirements for new buildings proposed for flood hazard areas and the substantial improvement of existing floodprone buildings are listed below:

- Buildings shall be designed and adequately anchored to prevent flotation, collapse, or lateral movement resulting from hydrodynamic and hydrostatic loads, including the effects of buoyancy.
- Building materials used below the design flood elevation shall be resistant to flood damage.
- Buildings shall be constructed by methods and practices that minimize flood damage primarily by elevating to or above the BFE, or by specially designed and certified floodproofing measures.

- Buildings shall be constructed with electrical, heating, ventilation, plumbing, and air conditioning equipment and other service facilities that are designed and/or located so as to prevent water from entering or accumulating within the components.
- If FEMA has not provided BFE data on the FIRM, the community must obtain, review, and reasonably utilize any BFE data available from a Federal, a State, or other sources for the purpose of regulating construction in SFHAs.

Subdivisions and Other New Development in the SFHA

- All proposals for subdivisions and other new developments greater than 50 lots or 5 acres (whichever is less) in an SFHA for which no BFEs are shown on the effective FIRM must be accompanied by 100-year flood elevation data.
- All proposals for subdivisions and other new development in the SFHA must be consistent with the need to minimize flood damage within the floodprone area.
- All public utilities and facilities (such as sewer, gas, electrical, and water systems for such subdivisions and other new developments) must be located and constructed to minimize or eliminate flood damage.
- Adequate drainage must be provided for all such subdivisions and new developments in order to reduce exposure to flood hazards.

NOTE

For more information about opening requirements for the walls of enclosures below the lowest floors of buildings in A Zones, see FEMA NFIP Technical Bulletin 1: *Openings in Foundation Walls and Walls of Enclosures*.

New and Replacement Water Supply Systems in the SFHA

- New and replacement water supply systems within the SFHA must be designed to minimize or eliminate infiltration of floodwaters.

New and Replacement Sanitary Sewage Systems in the SFHA

- New and replacement sanitary sewage systems in the SFHA must be designed to minimize or eliminate infiltration of floodwaters into the systems and discharges from the systems into floodwaters.
- Onsite waste disposal systems must be located to avoid impairment to them or contamination from them during flooding.

3.1.3.1 Minimum Requirements for Buildings in V Zones

The minimum requirements enforced by participating communities regarding newly constructed buildings, substantially damaged buildings, and substantially improved buildings in zones VE, V1–V30, and V pertain to the siting of the building, the elevation of the lowest floor in relation to the BFE, the foundation design, enclosures below the BFE, and alterations of sand dunes and mangrove stands (see 44 CFR Part 60.3(d)).

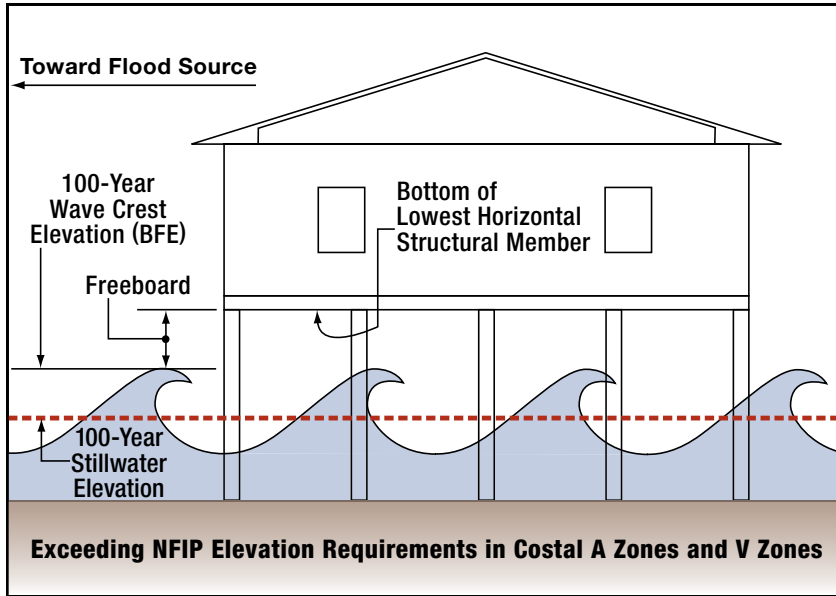

Figure 3-1.
MINIMUM NFIP V ZONE RE-
QUIREMENTS: In V Zones,
 buildings must be elevated
 on an open foundation (e.g.,
 pilings, posts, piers, or col-
 umns) so that the bottom of
 the lowest horizontal structural
 member is located at or above
 the BFE. (Source: FEMA 55)

Siting

All newly constructed buildings must be located landward of the reach of mean high tide (i.e., the mean high water line). In addition, human-caused alterations of sand dunes or mangrove stands are prohibited if those alterations would increase potential flood damage. Removing sand or vegetation from (or otherwise altering) a sand dune or removing mangroves may increase the potential of flood damage. Therefore, such actions must not be carried out without the prior approval of a local official.

Building Elevation

All newly constructed, substantially damaged, and substantially improved buildings must be elevated on open foundations using pilings, posts, piers, or columns so that the bottom of the lowest horizontal structural member of the lowest floor (excluding the vertical foundation members) is at or above the BFE (see Figure 3-1).

Foundation Design

The foundations for all newly constructed, substantially damaged, and substantially improved buildings (as well as the buildings attached to the foundations), must be anchored to resist flotation, collapse, and lateral movement due to the effects of wind and water loads acting simultaneously on all building components. A registered engineer or architect must develop or review the structural design, construction specifications, and plans for construction and must certify that the design and methods of construction to be used are in accordance with accepted standards of practice for meeting the building elevation and foundation design standards described above. In addition, erosion control structures and other structures (such as bulkheads, seawalls, and retaining walls) may not be attached to the building or its foundation.

Fill may not be used for the structural support of any building within zones VE, V1–V30, and V. Fill may be used in V Zones for minor landscaping and site drainage purposes provided that the fill does not interfere with the free passage of floodwaters and debris underneath the building or cause damages in the flow direction during coastal storms such that floodwaters will cause additional damages to buildings on the site or to any adjacent buildings.

Space Below the BFE

The space below all newly constructed, substantially damaged, and substantially improved buildings must either be free of obstructions or enclosed only by non-supporting breakaway walls, open latticework, or insect screening intended to collapse under water loads without causing collapse, displacement, or other structural damage to the elevated portion of the building or the supporting foundation system. Further, specific NFIP requirements are in place regarding permitted uses below the BFE and the use of flood-damage-resistant materials below the BFE. The enclosed area below the BFE can be used for parking, building access, or storage purposes, and any mechanical or utility equipment must remain protected or be elevated to the BFE.

NOTE

Although NFIP regulations permit below-BFE enclosures that meet the criteria presented here, many communities may have adopted ordinances that prohibit all such enclosures or that establish more stringent criteria, such as an enclosure size limitation.

Current NFIP regulatory requirements for breakaway walls are set forth at 44 CFR Part 60.3(e)(5). The regulations specify a design safe-loading resistance for breakaway walls of not less than 10 lb/ft² and not more than 20 lb/ft². Regulations also provide for the use of alternative designs that do not meet the specified loading requirements. Generally, the use of breakaway walls built according to such designs is permitted if a registered professional engineer or architect certifies that the walls will collapse under a water load less than that which would occur during the base flood and that the elevated portion of the building and supporting foundation system will not be subject to collapse, displacement, or other structural damage due to the effects of wind and water loads acting simultaneously on all building components.

NOTE

For more information about enclosures, the use of space below elevated buildings, and breakaway walls, see FEMA 499, *Home Builder's Guide to Coastal Construction Technical Fact Sheet Series*.

Research conducted for FEMA and the National Science Foundation by North Carolina State University (NCSU) and Oregon State University (OSU) including full-scale tests of breakaway wall panels provides the basis for prescriptive criteria related to the design and construction of alternative-type breakaway wall panels that do not meet the requirement for a loading resistance of 10–20 lb/ft². These criteria are presented in the 2008 FEMA NFIP Technical Bulletin 9: *Design and Construction Guidance for Breakaway Walls Below Elevated Coastal Buildings* (FIA-TB-9). The criteria address breakaway wall construction materials (including wood framing, light-gauge steel framing, and masonry); attachment of the walls to floors and foundation members; utility lines; wall coverings (such as interior and exterior sheathing, siding, and stucco); and other design and construction issues. The bulletin also describes the results of the NCSU/OSU tests, which are described in greater detail in *Behavior of Breakaway Walls Subjected to Wave Forces: Analytical and Experimental Studies* (Tung et al., 1999).

3.1.3.2 Minimum Requirements for Buildings in A Zones

In addition to the general requirements stated above, the following minimum requirements are specific to buildings and structures located in zones AE, A1–A30, AO, and A. The discussion below addresses how each of the requirements is defined according to the flood zone.

- The elevation of the top of the lowest floor (i.e., Finished Floor Elevation (FFE)), including finished basements, in relation to the BFE or the depth of the 100-year-flood event (FFE must be at or above BFE).
- Enclosed areas below the lowest floor. (Note that these requirements are the same for coastal and non-coastal A Zones.)

Building Elevation in Zones AE and A1-A30

The top of the lowest floor (including the basement floor) of all newly constructed, substantially damaged, and substantially improved buildings must be positioned at or above the BFE (see Figure 3-2). If a closed foundation is used, flood openings must be present to account for hydrostatic pressure.

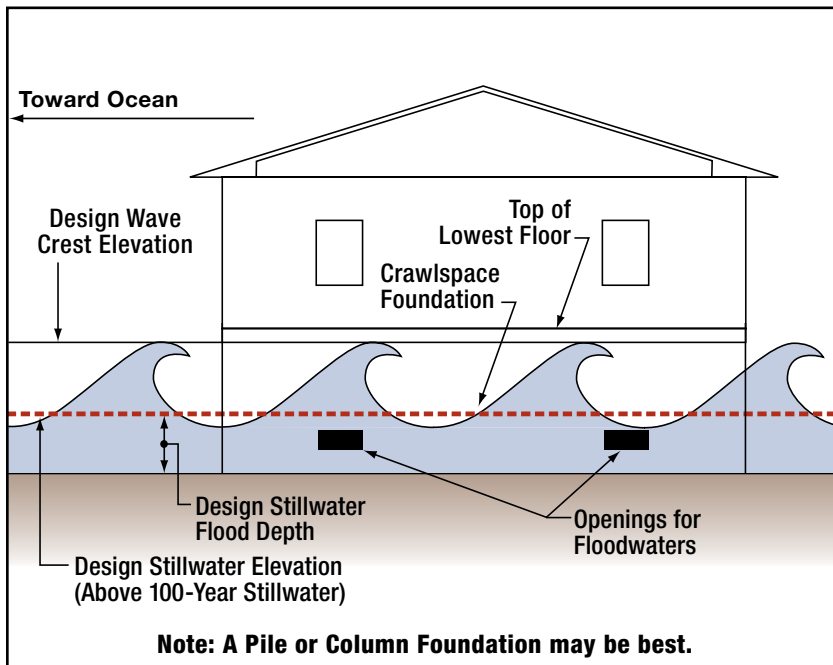

Figure 3-2.
MINIMUM NFIP A ZONE REQUIREMENTS:
 The lowest floors of buildings in zones AE, A1–A30, and A must be positioned at or above the BFE. Foundation walls below the BFE must be equipped with openings that allow the automatic entry of floodwaters so that interior and exterior hydrostatic pressures can equalize. (Source: FEMA 55)

Building Elevation in Zone A

FIRMs do not present BFEs in SFHAs designated as Zone A (i.e., unnumbered A Zones). The lowest floors of buildings in Zone A must be elevated to or above the BFE whenever BFE data is available from other sources. If no BFE data is available, communities must ensure that the building is constructed with methods and practices that minimize flood damage. If a closed foundation is used, flood openings must be present in the foundation walls in order to account for hydrostatic pressure.

Building Elevation in Zone AO

Zone AO designates areas where flooding is characterized by shallow depths (averaging 1 to 3 feet) and/or unpredictable flow paths. In Zone AO, the top of the lowest floor (including the basement floor) of all newly constructed, substantially damaged, and substantially improved buildings must be above the highest grade adjacent to the building by at least the depth of flooding in feet shown on the FIRM. For example, if the flood depth shown on the FIRM is 3 feet, the top of the lowest floor must be positioned at least 3 feet above the highest grade adjacent to the building. If no depth is shown on the FIRM, the minimum required height above the highest adjacent grade is 2 feet. If a closed foundation is used, flood openings must be present in the foundation walls to account for hydrostatic pressure.

Note that areas adjacent to V Zones (such as behind bulkheads or on the back sides of dunes) are sometimes designated as Zone AO. For such areas, this guide encourages the use of open foundations as required in V Zones (see Subsection 3.2.4.3 of this guide) for Zone AO.

Enclosures Below the Lowest Floor in Zones AE, A1–A30, AO, and A

Enclosed space below the lowest floors of newly constructed, substantially damaged, and substantially improved buildings may be used only for vehicle parking, building access, or storage purposes. The walls of such areas must be equipped with openings designed to allow the automatic entry and exit of floodwaters so that interior and exterior hydrostatic pressures will equalize during flooding. Designs for openings must either meet or exceed the following minimum criteria:

1. A minimum of two openings with a total net area of not less than 1 square inch for every 1 square foot of enclosed area subject to flooding must be provided.
2. The bottoms of all openings must be no higher than 1 foot above grade.
3. The openings may be equipped with screens, louvers, valves, or other coverings or devices—provided that they permit the automatic entry and exit of floodwaters.

An alternative to meeting Criterion 1 above is to provide a certification by a registered engineer or architect that states that the openings are designed to automatically equalize hydrostatic forces on exterior walls by allowing the entry and exit of floodwaters. Even if such a certification is provided, however, the openings must still meet criteria 2 and 3.

3.1.3.3 Recommendations for Coastal A Zones and V Zones

The NFIP regulations currently do not differentiate between coastal and non-coastal A Zones. Because Coastal A Zones may be subject to the types of hazards present in V Zones (such as wave effects, velocity flows, erosion, scour, and high winds), this guide recommends that buildings in Coastal A Zones meet the NFIP regulatory requirements for V Zone buildings (i.e., the performance requirements concerning resistance to flotation, collapse, and lateral movement, as well as the prescriptive requirements for elevation, foundation type, engineering certification of design and construction, enclosures below the BFE, and the use of structural fill).

To provide a greater level of protection against the hazards typical to Coastal A Zones and V Zones, this guide recommends the following guidance as good practice for the siting, design, and construction of buildings within those zones:

- The building should be located landward of both the long-term erosion setback and the limit of 100-year flood event erosion, rather than simply landward of the reach of mean high tide.
- The bottom of the lowest horizontal structural member should be elevated above—rather than to—the BFE (i.e., freeboard should be provided; see Figure 3-3).
- Open latticework or screening should be used in lieu of breakaway walls in the space below the elevated building or, at a minimum, the use of solid breakaway wall construction should be minimized.
- In V Zones, the lowest horizontal structural members should be oriented perpendicularly to the expected wave crest.

NOTE

The term “Coastal A” refers to the area within the A Zone where breaking waves are between 3 feet and 1.5 feet high. These areas are not specifically delineated on FIRMs.

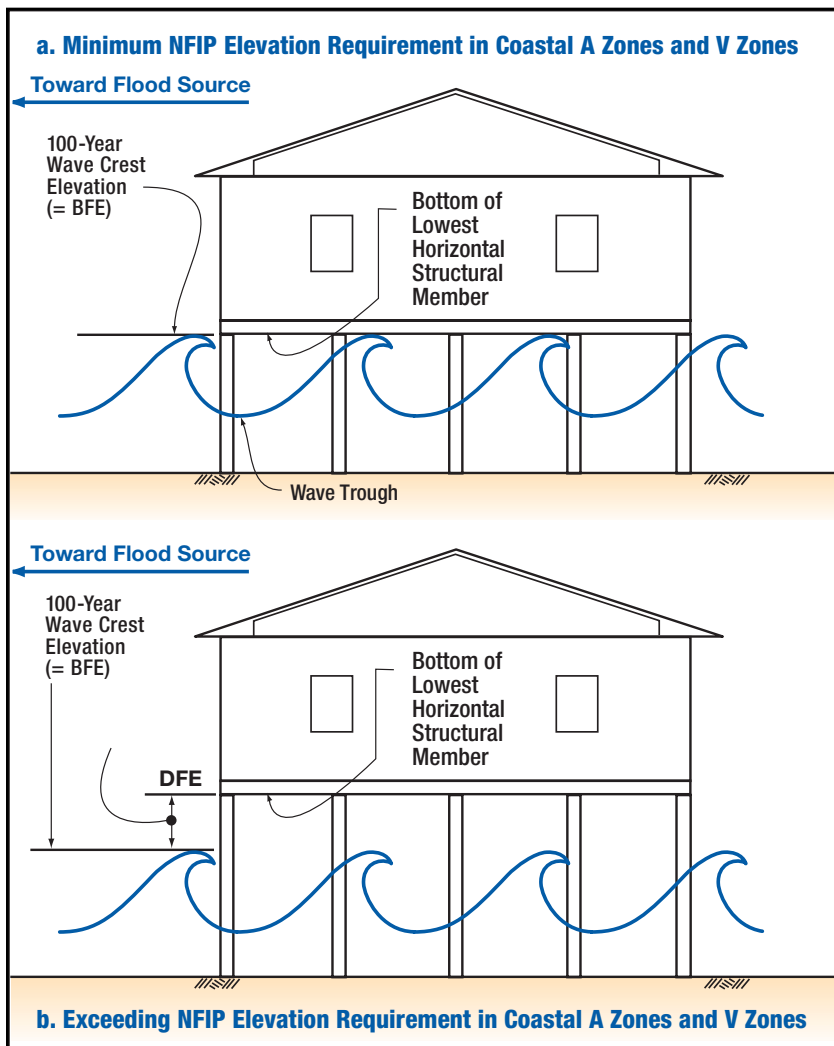

Figure 3-3. RECOMMENDED ELEVATION FOR BUILDINGS IN COASTAL A ZONES AND V ZONES: The bottom of the lowest horizontal structural member must be positioned above the BFE (rather than elevated to the BFE, as shown in Figure 3-1). The additional amount of elevation above the BFE is referred to as “freeboard.” In V Zones, the lowest horizontal structural members should be perpendicular to the expected wave crest. (Source: FEMA 55)

3.2 Building Codes and Standards

The purpose of a building code is to establish the minimum acceptable design and construction requirements necessary for protecting the public health, safety, and welfare within the built environment. All building codes and standards are developed through a public

consensus process. Building codes apply primarily to new construction, but may also apply to existing buildings that are being rebuilt, retrofitted, or renovated. Codes may also apply when a building is undergoing a change in use, as defined by the code. The building code specifies the applicable climatic and geographic design criteria (including rain and snow loads, wind speed, seismic design category, frost depth, termite susceptibility, flood hazards, air freezing index, and mean annual temperature).

The most widely adopted model codes are developed by the International Code Council (<http://www.iccsafe.org>). As of mid 2008, there has been at least one community in all 50 states that has adopted at least one or more of the I-Codes (including the IBC, IRC, International Existing Building Code, and a series of codes for mechanical, plumbing, fuel gas, and onsite sewage installations). This guide references the 2006 editions of the IBC and IRC along with ASCE 7-05 and ASCE 24-05 as though they have been adopted in every jurisdiction. If these codes have not been adopted in the reader's jurisdiction without modification (such as with an IBC-based code or with local/state amendments), the requirements set forth here may be considered guidance.

During the development of the I-Codes, FEMA was consulted to ensure that the direction given in the codes remains consistent with the minimum requirements of the NFIP. Since 2000, the I-Codes have included provisions for buildings in flood hazard areas, and the 2003 and 2006 editions have been deemed by FEMA to be consistent with the NFIP.

The IBC is a performance code that generally requires buildings and structures to be individually designed to meet the requirements of the code and various referenced standards. Two important standards referenced—(1) ASCE 7-05 outlining loading criteria for wind, flood, and environmental loads and (2) ASCE 24-05—include provisions pertaining to flood hazards. These standards are briefly described in Sections 3.2.2.1 through 3.2.3.

The IRC addresses relevant design criteria (loads) in a more prescriptive approach so that some one- and two-family homes can be built without individual designs prepared by architects and engineers (with the exception of homes in A and V Zones). Homes may be designed and constructed to the IRC criteria, but generally a prescriptive approach to design is used for inland construction. Due to the IRC not being prescriptive about flood design, coastal construction requirements typically lead to individual designs of residential structures.

NOTE

Applicable climatic and geographic design criteria are found in IRC Table 301.2(1).

NOTE

ASCE 7-05 outlines methods to determine design loads and load combinations in flood hazard areas (including hydrostatic loads, hydrodynamic loads, wave loads, and debris impact loads). To compute the loads and load combinations, the designer must identify site-specific characteristics (including flood depths, velocities, waves, and the likelihood that debris impacts need to be considered).

ASCE 24-05 addresses design requirements for buildings in Coastal High Hazard Areas.

Although not specifically covered in this guide, one other notable building code adopted in some jurisdictions is NFPA 5000, *Building Construction and Safety Code*, developed by the National Fire Protection Association. This code includes provisions for buildings in flood hazard areas. The NFPA also develops standards, including NFPA 225, *Model Manufactured Home Installation Standard*, the first such standard to include provisions for manufactured home installation within flood hazard areas. This standard provides some guidance on appropriate measures required for manufactured homes.

3.2.1 Flood and Wind Requirements in the IBC and IRC

The IBC addresses flood loads and flood-resistant construction primarily in Section 1612 (Flood Loads), which refers to the consensus standards ASCE 7-05 (in Chapter 5) and ASCE 24-05. Similarly, wind loads and wind-resistant construction are addressed in Section 1609 (Wind Loads) of the IBC. The IBC states that wind loads should be calculated as indicated in Chapter 6 of ASCE 7-05. The code then defines prescriptive methods for designing openings, louvers, and roof systems. Flood loads, wind loads, and load combinations are specified in Section 1605. The designer must identify the pertinent, site-specific characteristics and then use ASCE 7-05 to determine the specific loads and load combinations. The IBC, in effect, is similar to a local floodplain ordinance that requires determination of the environmental conditions (e.g., mapped flood hazard area, BFE/depth of water) and then specifies certain conditions that must be met during design and construction. The body of the IBC (together with Appendix G, if specifically adopted by the AHJ) addresses all of the key building and development requirements of the NFIP. If the AHJ chooses not to adopt the I-Code, the applicable code should comply with minimum NFIP requirements.

NOTE

A crosswalk of the NFIP regulations and the IBC and IRC provisions is found in the publication *Reducing Flood Losses through the International Code Series: Meeting the Requirements of the NFIP* (published by the ICC) and in Table 3-1, which is located at the end of this chapter.

The IRC is a prescriptive code that generally provides a prescriptive design approach that simplifies the design process and, as a result, does not always lead to individual designs for residential buildings. The IBC can be used if the building does not meet the guidance developed for the IRC. However, to ensure consistency with the NFIP in coastal high-hazard areas (V Zones), the IRC requires submission of documentation by a registered design professional stating that the design and methods of construction to be used meet applicable requirements. The IRC applies to one- and two-family dwellings and to some townhouses. In NFIP terminology, the IRC is used for residential structures.

NOTE

Design Flood Elevation (DFE)
– At a minimum, the Base Flood Elevation (i.e., elevation of the 100-year flood event). However, the DFE could be higher due to freeboard or additional elevation mandated by the authority having jurisdiction.

The IRC addresses flood-resistant construction primarily in Section R324 (Flood-Resistant Construction, renumbered from R323 in previous versions), although provisions for mechanical and plumbing installations are included in pertinent sections of the code. Section R301 (Design Criteria) of the IRC addresses the limitations of the prescriptive aspects of the code based upon basic wind speed requirements and stipulates that if the wind speed requirements exceed those in the prescriptive guidance, the structure should be designed in accordance with one of five codes or standards (see the list on the following page). Section R301.2.1.1 should be consulted to verify that the applicable/supplemental code or design guidance is being used.

- American Forest & Paper Association, *Wood Frame Construction Manual for One- and Two-Family Dwellings* (WFCM)
- Southern Building Code Congress International, *Standard for Hurricane-Resistant Residential Construction* (SSTD 10)
- ASCE/SEI 7-05, *Minimum Design Loads for Buildings and Other Structures*
- American Iron and Steel Institute, *Standard for Cold-Formed Steel Framing: Prescriptive Method for One- and Two-Family Dwellings* (COFS/PM) with supplement to Standard for Cold-Formed Steel Framing—Prescriptive Method for One- and Two-Family Dwellings
- Concrete construction shall be designed in accordance with the provisions of the IRC.

The IRC does not specifically refer to ASCE 7-05 or ASCE 24-05 for flood loads. However, Section R324.3.6 does require a registered design professional to prepare and seal the construction documents, thus requiring the design professional to use ASCE 7-05 and ASCE 24-05 when designing flood-resistant structures.

3.2.1.1 Minimum Flood Requirements of the Building Codes

Buildings constructed in A and V Zones must comply with specific provisions of the IBC or the IRC, if they are adopted. The summary below is an overview of the most significant requirements, but it is not a complete listing of the codes and should not be relied upon for ensuring full compliance with either the IBC or the IRC. The requirements within the codes should be evaluated during the plan review process before issuance of the building permit. The permit process is discussed in detail in Chapter 4.

NOTE

In the terminology of the NFIP, the International Building Code is used for non-residential structures. Note, however, that the IBC does apply to some types of residential structures, such as multi-family dwellings.

The requirements outlined in IRC Section R324 are summarized below:

1. All structural systems must be designed to resist flotation, collapse, or permanent lateral movement due to loads and stresses from flooding.
2. All structures prone to flooding shall be designed to minimize flooding.
3. All structures shall be elevated for compliance with the DFE, as established by locally adopted ordinances and shall be at (at a minimum) the 100-year flood elevation. A licensed architect, engineer, or land surveyor must determine and confirm that the floor level conforms to that particular community's DFE. All floor levels must be established at or above the BFEs indicated on the FIRM.
4. All mechanical and electrical equipment and components shall be elevated to the minimum DFE.

NOTE

The 2009 IRC will require 1 foot of freeboard in V Zones and Coastal A Zones.

5. All new and existing water supply and sanitary systems shall be designed to eliminate or minimize the infiltration of floodwater into the system.
6. All wood used below the DFEs shall be pressure-preservative-treated or be decay-resistant.
7. In V Zones (or Coastal A by local adoption), all enclosed areas below the DFE shall be used solely for the parking of vehicles, building access, and storage. In addition, the enclosures shall be made compliant with the provisions of the code to allow floodwater movement.
8. All foundations shall be designed to comply with all provisions of the codes.

3.2.1.2 Minimum Wind Requirements of the Building Code

Building safety depends upon more than the adopted codes and the standards that they reference. While building-code effectiveness depends partly on the presence of an effective building department within that community, true building safety is most likely achieved when buildings are properly designed by trained professionals, who have the resources and ongoing support they need to stay apprised of advancements in building safety.

An effective building safety system provides uniform interpretations of the code, product evaluations, and professional development and certification for inspectors and plan reviewers. Local building departments play a key role in ensuring that buildings are designed and constructed in accordance with applicable building codes.

Building codes, however, are not all-inclusive. Omissions or conflicts with other rules, ordinances, or legislation may exist. General limitations to wind provisions in the building codes include the following:

- Because codes are adopted and enforced at the local or state level, the authority having jurisdiction has the power to eliminate or modify wind-related provisions of a model code, or to write its own code instead. In jurisdictions for which wind-related provisions of the current model code are not adopted and enforced, buildings and critical facilities are more susceptible to wind damage. In addition, a time lag may exist between the time a model code is updated and the time it is implemented by a jurisdiction. Buildings designed to the minimum requirements of an outdated code are, therefore, not taking advantage of the latest industry knowledge. These buildings are prone to poorer wind performance, as compared to buildings designed according to current model codes.
- Adopting the current model code alone does not ensure good wind performance. To achieve good wind performance (in addition to good design), the construction of the building itself must be effectively executed and the building must be adequately maintained and repaired.

The 2006 editions of the IBC and IRC are regarded as effective codes, when they are carefully followed and their rules properly enforced. Neither the 2006 editions of the IBC or the IRC account for the wind loads exerted by tornadoes. These loads are generally considered to be too excessive for practical design of entire buildings. The codes focus on creating structures that will sustain minimal damage when exposed to the design hazard. The codes are designed to protect structures; however, it is important to note that the codes are not intended to create storm shelters. (Occupants should seek refuge in an appropriate shelter or FEMA safe room in the event of a storm.)

The 2000, 2003, and 2006 editions of the IBC rely on several referenced standards and test methods developed or updated during the 1990s. Prior to adoption, most of these standards and test methods had not been validated by actual building performance during design-level wind events. The hurricanes of 2004 and 2005 provided an opportunity to evaluate the actual performance of buildings designed and constructed to the minimum provisions of the IBC. Building performance evaluations conducted by FEMA revealed the need for further enhancements. A limitation of the 2006 editions of the IBC and IRC involves some of the test methods used to assess wind and the wind-driven rain resistance of building-envelope components. However, before this code limitation can be overcome, research must be conducted and new test methods developed.

These limitations should not be seen as inadequacies in the codes, but rather as issues about which building officials should remain aware. Overwhelming evidence suggests that structures built to IBC and IRC standards perform significantly better during storm events than buildings not constructed to code. In many cases, structures built to IBC and IRC standards were the only ones to survive storm loads in impacted areas.

3.2.1.3 Evolution of Wind Requirements in the Building Codes and Standards

Recognition of increased uplift loads at the roof perimeter and corners. Prior to the 1982 editions of the Standard Building Code and the Uniform Building Code, and the 1987 edition of the National Building Code, these model codes did not account for the increased uplift at the roof perimeter and corners. Therefore, buildings designed in accordance with earlier editions of these codes are very susceptible to the loss of the roof covering and/or roof decking during high-wind events.

Adoption of ASCE 7 for design wind loads: Although the Standard Building Code, the Uniform Building Code, and the National Building Code permitted the use of ASCE 7, the 2000 edition of the IBC was the first model code to require ASCE 7 for determining wind design loads. The IRC also recommends the use of ASCE 7 for wind design or other methods, but provides alternative tables for prescriptive design pressures for qualified buildings.

NOTE

ASCE 7-05 requires the protection of glazed openings in windborne debris areas within hurricane-prone regions. Glazing protection can be an impact-resistant glazing protection (such as laminated glass or polycarbonate) or shutters or screens tested in accordance with ASTM standards specified in ASCE 7-05. The windborne debris-protection criteria were developed to minimize property damage and to improve building performance. (The criteria were not developed for occupant protection.)

Roof coverings: Several performance and prescriptive requirements pertaining to the wind resistance of roof coverings have been incorporated into the model codes. Poor performance of roof coverings was widespread during hurricanes Hugo (1989) and Andrew (1992). Prior to the 1991 editions of the Standard Building Code and the Uniform Building Code, and the 1990 edition of the National Building Code, these model codes did not directly address roof covering wind loads and test methods for determining uplift resistance. Most of these additional provisions were added following Hurricane Andrew. Following these storms, Building Performance Assessment Teams (BPAT) were dispatched to evaluate construction techniques used on various buildings and gather information based upon the damages. These BPATs (now called Mitigation Assessment Teams [MAT]) were comprised of technical experts from FEMA, code experts, and consultants from public and private entities. The BPATs and MATs have made recommendations on improving building performance and influenced future codes in this and other areas of study. Changes to the building codes based upon these recommendations continue to be made through

the 2006 edition of the IBC (such as, Section 1504.8 which added a provision prohibiting aggregate roof surfaces in hurricane-prone regions) and also future editions which are currently in the consensus development process.

Glazing protection: The 2000 edition of the IBC was the first model code to address windborne debris requirements for glazing in buildings located in hurricane-prone regions (via reference to the 1998 edition of ASCE 7). The 1995 edition of ASCE 7 was the first edition of that standard to address windborne debris requirements.

Parapets and rooftop equipment: The 2003 edition of the IBC was the first model code to address wind loads on parapets and rooftop equipment (via reference to the 2002 edition of ASCE 7, which was the first edition of ASCE 7 to address these elements).

3.2.2 ASCE 7 Requirements

The ASCE develops and maintains the consensus standard for load determination on buildings and structures: ASCE 7-05. This standard specifies the loads and load combinations to be used in design and is incorporated by references in the 2006 editions of both the IBC and the IRC. This standard is the basis for loadings used in many of the prescriptive methods outlined in the IRC. The design loads for new or modified construction consider permanent and temporary loads (such as snow and rain loading), as well as loads from other more significant natural hazards (such as seismic events, high wind, and flood loads).

For this guide, flood- and wind-load requirements are discussed because they are the most significant load conditions within coastal areas. The commentary sections of ASCE 7 provide detailed discussions of these and other loads.

3.2.2.1 Flood Requirements

Coastal areas experience several flood loads that can occur simultaneously. Storm surge, debris impact, erosion, and scour can contribute to loads exerted on a building. The following sections of ASCE 7 address flood loads:

- Section 2: Combinations of Loads, including different load combinations for V Zones and Coastal A Zones.
- Section 5: Flood Loads, which covers hydrostatic, hydrodynamic, wave, and impact loads. Load criteria for breakaway walls are included.

In recognition of the growing awareness that waves with heights between 1.5 feet and 3 feet high (the cutoff used to delineate FEMA's V Zone) can cause considerable damage, ASCE 7-05 incorporates the concept of the Coastal A Zone and specifies that designers must determine breaking wave loads on structures within these areas.

3.2.2.2 Wind Requirements

Because of their geographic location, many coastal communities are susceptible to high-wind events, such as hurricanes, tornadoes, and nor easters. The wind pressures calculated in accordance with ASCE 7-05 are applied to tributary areas on the building. These loads result in forces that should be evaluated at connections and at stresses in structural members, or to the Main Wind Force Resisting System (MWFRS). Forces are also calculated for wall sheathing, roof panels, windows, and doors all of which is referred to collectively as the components and cladding (C&C). Calculated wind pressures are largely dependant upon site location, topography, building shape and configuration, and building importance. Figure 3-4 is a section of a map showing areas along the East Coast of the United States that are subject to hurricanes. ASCE 7 sections that pertain to wind loads and loading combinations are:

- Section 2: Combinations of Loads, including different load combinations for V Zones and Coastal A Zones.
- Section 6: Wind Loads, which covers MWFRS and C&C. A discussion of windborne debris is also included in this section.



Figure 3-4.

The hurricane-prone regions along the coastline of the United States. This map is based upon ASCE 7-05, Figure 6-1.

3.2.3 ASCE 24 Requirements

ASCE develops and maintains the consensus standard ASCE 24-05. This standard specifies minimum requirements for flood-resistant design and construction of buildings and structures located in flood hazard areas, including floodways and coastal high-hazard areas. The standard applies to new buildings and existing structures that are not designated as historic structures but which are undergoing substantial repair or improvements.

Basic design requirements address flood loads and load combinations, elevation of the lowest floor, recommendations about the DFE, foundation requirements and geotechnical considerations, use of fill, and anchoring and connections. As a function of the type of flood hazard area, enclosures may need breakaway walls or must meet requirements for flood openings (either prescriptive or engineered). ASCE 24-05 does not address wind hazards specifically, but does reference the fact that load combinations on structures shall be in accordance with ASCE 7-05, which would include wind loads.

For buildings in coastal high-hazard areas, V Zones and Coastal A Zones, ASCE 24-05 includes specifications for the design of pile, post, pier, column, and shear wall foundations. Considerable detail is specified for pilings as a function of pile types and connections.

ASCE 24-05 states that residential structures in V Zones and Coastal A Zones are required to have open foundations and shall have the lowest horizontal structural member of the lowest floor positioned at or above the DFE. The minimum elevation requirements are based upon the structural member's orientation to the direction of waves approaching. For parallel members, the requirement is DFE and the perpendicular members are required to be BFE + 1 or DFE (whichever is higher).

The following topics are also addressed within ASCE 24-05: materials, dry and wet floodproofing, utility installations, building access, and miscellaneous construction (e.g., decks, porches, patios, garages, chimneys and fireplaces, pools, and above- and below-ground storage tanks). It is important to note that some sections of ASCE 24-05 exceed the minimum requirements set forth in the NFIP; specifically freeboard requirements. A structure designed to ASCE 24-05 standards, which include freeboard criteria, would likely perform better during a design event (by resisting flood loads better) than a building not constructed to the minimum NFIP criteria that recommend, but do not require freeboard. Until such standards and approaches are directly incorporated into the building codes or regulations, without options, then these standards and approaches should be considered best practices and not requirements.

3.3 Coastal Barrier Resources Act of 1982

The Coastal Barrier Resources Act (CBRA) of 1982 was enacted to protect vulnerable coastal barriers from development; minimize the loss of life; reduce expenditures of Federal revenues; and protect fish, wildlife, and other natural resources. This law established the Coastal Barrier Resources System (CBRS), which is managed by the Department of the Interior's (DOI) United States Fish and Wildlife Service (USFWS). The law restricts Federal expenditures and financial assistance that could encourage the development of coastal barriers. The CBRA does not prohibit privately financed development; however, it does prohibit most new Federal financial assistance-including federally backed flood insurance-in locations within the CBRS (also referred to as CBRA areas). Flood

insurance may not be sold for buildings within the CBRS that were constructed or substantially improved after October 1, 1983. The financial risk of building in these areas is transferred from Federal taxpayers directly to those who choose to reside in or invest in these areas.

CBRS boundaries are shown on a series of maps produced by DOI. In addition, FEMA has transferred CBRS boundaries to many FIRMs so that insurance agents and underwriters may determine eligibility for flood insurance coverage. Before constructing a new building, substantially improving an existing building, or repairing a substantially damaged building, the designer or property owner should review the FIRM and confirm for the building official that the property is not within the CBRS. If the structure is considered within the CBRS, the building official should notify the designer or property owner of any special ordinances specific to structures within the CBRS. In situations where the FIRM does not allow for a definitive determination, the designer or property owner should consult local officials. In some situations, it may be necessary to request a determination from USFWS, based upon DOI maps.

NOTE

Any building within a Coastal Barrier Resources System (CBRS) area that is constructed or substantially improved after October 1, 1983 (or the date of designation for areas added to the system after 1991) is not eligible for federal flood insurance or other federal financial assistance. The same restriction applies to substantially damaged buildings in a CBRS area that are repaired or renovated after those dates.

3.4 Coastal Zone Management Regulations

The Coastal Zone Management (CZM) Act of 1972 encourages the adoption of coastal zone policies by coastal states acting in partnership with the Federal government. CZM regulations have been adopted by 34 states and territories. For information on the status of state and national CZM programs, visit the Web site of the National Oceanic and Atmospheric Administration (NOAA) at <http://oceanservice.noaa.gov/topics/coasts/management/>.

Each state's CZM program contains provisions to:

- Protect natural resources
- Manage development in high-hazard areas
- Manage development to achieve quality coastal waters
- Give development priority to coastal-dependent uses
- Have orderly processes for the siting of major facilities
- Locate new commercial and industrial development in, or adjacent to, existing developed areas
- Provide public access for recreation
- Redevelop urban waterfronts and ports, and preserve and restore historic, cultural, and aesthetic coastal features
- Simplify and expedite governmental decision making actions

- Coordinate state and Federal actions
- Give adequate consideration to the views of Federal agencies
- Assure that the public and local governments are consulted during coastal decision making
- Comprehensively plan for and manage living marine resources

Most state coastal zone regulations control construction seaward of a defined boundary or setback line, such as a dune or road. Many states regulate or prohibit construction seaward of a second setback line, which is based upon erosion. Some setback lines are updated when erosion rates are assessed; lines that follow physical features (such as dune lines) are not fixed and float as the physical feature shifts over time. Other examples of state coastal regulations include the placement or prohibition of shore protection structures and the protection of dunes. These restrictions should be carefully considered by state and local regulatory officials because guidance on the regulations is site-specific to coastal conditions within that area.

3.5 Use of the NFIP and Code Crosswalk

To provide information on the guidance in each document or to identify the location of the information within the document, this section provides a useful crosswalk summary of NFIP regulations (as well as the IBC, IRC, ASCE 24-05, and ASCE 7-05) for each coastal zone. In many cases, information is provided about whether the guidance is a requirement of that document or a best-practices recommendation. The crosswalk refers to the BFE; however, some jurisdictions may include freeboard, and, in these cases, the guidance should be understood as the DFE.

Table 3-1 was developed using Appendix B and Appendix C of *Reducing Flood Losses Through the International Codes* (ICC/FEMA, 2nd Edition, 2005) and updated to reflect the 2006 versions of the IBC and IRC. This crosswalk summary is intended to provide guidance on the locations of applicable code sections. It is not a complete list, and the local official should be encouraged to consult that particular code.

(Page intentionally left blank)

3 INVESTIGATING REGULATORY REQUIREMENTS

Table 3-1. Code Crosswalk

	NFIP	V Zone	Coastal A
GENERAL REQUIREMENTS			
Design and Construction	60.3(a)(3)(i) New construction and substantial improvements to be designed and adequately anchored to prevent flotation, collapse, or lateral movement.	Requirement: Building and its foundation must be designed, constructed, and anchored to prevent flotation, collapse, and lateral movement due to simultaneous wind and water load.	Requirement: Building must be designed, constructed, and anchored to prevent flotation, collapse, and lateral movement resulting from hydrodynamic and hydrostatic loads, including the effects of buoyancy. Recommendation: Same as V Zone.
Materials	60.3(a)(3)(ii) New construction and substantial improvements to be constructed with materials resistant to flood damage.	Requirement: Structural and nonstructural building materials at or below the BFE must be flood-resistant.	Requirement: Structural and nonstructural building materials at or below the BFE must be flood resistant.
Siting	60.3(d)(3) Prohibit floodway encroachment unless no impact on flood levels is demonstrated. 60.3(e)(3) All new construction shall be landward of mean high tide. 60.3(e)(7) Alteration of sand dunes and mangrove stands that increases	Requirement: All new construction shall be landward of mean high tide; alteration of sand dunes and mangrove stands that increases the potential of flood damage is prohibited. Recommendation: Site new construction landward of the long-term erosion setback and landward of the area subject to erosion during the 100-year coastal flooding event.	Requirement: Encroachments into the SFHA are permitted as long as they do not increase the BFE by more than 1 foot; encroachments into the floodway are prohibited. Recommendation: Same as V Zone.
FOUNDATION			
Structural Fill	60.3(e)(6) Prohibit the use of fill for structural support of buildings in V Zones.	Prohibited	Allowed, but not recommended; compaction required where used; protect against scour and erosion.
Solid Foundation		Prohibited	Allowed, but not recommended.
Open Foundation		Required	Not required, but recommended.
Lowest Floor Elevation (non V Zone)	60.3(c) Require all new and substantially improved structures: (2) to have the lowest floor elevated to or above the flood elevation or, (3) be floodproofed (nonresidential only)	N/A	Requirement: Top of floor must be at or above BFE Recommendation: Elevate bottom of lowest horizontal structural member to or above BFE
Bottom Lowest Horizontal Structural Member	60.3(e)(4) Require all new and substantially improved construction to be elevated on pilings and columns so that: (i) bottom of lowest horizontal structural member is at or above the flood elevation, (ii) pile or column foundation and structure are anchored to resist flotation, collapse, and lateral movement due to wind and water loads; registered design professional to develop or review the design, specifications, and plans and provide certification.	Requirement: Bottom must be at or above the BFE.	Allowed below BFE but not recommended. Recommendation: Same as V Zone.
Orientation of Lowest Horizontal Structural Member	None	No requirement Recommendation: Orient perpendicular to wave crest	No requirement
Freeboard	None	Not required, but recommended	Not required, but recommended
Enclosures Below the BFE (non V Zones)	60.3(c)(5) Fully enclosed areas below elevated buildings are to be: limited in use (parking, access, storage); provided with flood openings that meet minimum criteria or are designed by a registered design professional.	N/A	Allowed, but not recommended ; if an area is fully enclosed, the enclosure walls must be equipped with openings to equalize hydrostatic pressure; size, location, and covering of openings governed by regulatory requirements. Recommendation: If enclosure is constructed, use breakaway walls, open lattice, or screening (as required in V zones).
Enclosures Below the BFE (V Zones)	60.3(e)(5) Enclosed areas, if any, are to be constructed with non-supporting, breakaway walls, lattice, or screening intended to collapse under wind and water loads; uses limited to parking, building access, or storage.	Prohibited, except for breakaway walls, open lattice, and screening.	N/A
Sanitary Sewer	60.3(a)(6)(i) New/replacement sanitary sewage system designed to minimize/eliminate infiltration/discharges (ii) on-site waste disposal systems located to avoid impairment or contamination.		
Utilities	60.3(a)(3)(v) Electrical, heating, ventilation, plumbing, and air-conditioning equipment and other service facilities to be designed and/or located to protect components.	Requirement: Must be designed, located, and elevated to prevent floodwaters from entering and accumulating in components during flooding.	Requirement: Must be designed, located, and elevated to prevent floodwaters from entering and accumulating in components during flooding.
CERTIFICATION			
Permits	60.3(b)(1) Require permits for all development, including placement of manufactured homes.	V Zone Certificate, Breakaway Wall Certificate, and Elevation Certificate	Elevation Certificate
MANUFACTURED HOUSING			
General	60.3(b)(8) Require installation of MFH using methods to minimize flood damage, including anchoring, and to resist wind forces.		

Table 3-1. Code Crosswalk Continued

A Zone	IBC	IRC	ASCE 24 and ASCE 7	Other
GENERAL REQUIREMENTS				
Requirement: Building must be designed, constructed, and anchored to prevent flotation, collapse, and lateral movement resulting from hydrodynamic and hydrostatic loads, including the effects of buoyancy. Recommendation: Same as V Zone	1605.2.2 (reference ASCE 7) 1605.3.1.2 (reference ASCE 7) 1612.4 (reference ASCE 24) 1612.5.2, 3403.1.1	R301.1 R301.2.4 R323.1	ASCE 24 Sec. 5.6 ASCE 24 Sec. 1.5.1	
Requirement: Structural and non-structural building materials at or below the BFE must be flood resistant.	801.1.3, 1403.5	R324.1.7	ASCE 24 Ch. 5	FEMA TB #2 FEMA TB #8
Requirement: Encroachments into the SFHA are permitted as long as they do not increase the BFE by more than 1 foot; encroachments into the floodway are prohibited.	App. G 103.5 App. G 103.6 App. G 103.7 App. G 401.1 App. G 401.2	R301.2.4 R324.3.1	ASCE 24 Sec. 2.3 ASCE 24 Ch. 3 ASCE 24 Sec. 4.3	FEMA EMI IS-9, FEMA FIA-12
FOUNDATION				
Allowed; compaction required where used; protect against scour and erosion.	App. G 401.1	R324.3.2	ASCE 24 Sec. 2.4	FEMA TB #5
Allowed		R324.2.3	ASCE 24 Sec. 2.5 ASCE 7 Sec. 5.4.4.2	FEMA TB #5
Allowed			ASCE 7 Sec. 5.4.4.1 ASCE 24 Sec 4.5.5	FEMA TB #5
Requirement: Top of floor must be at or above BFE	1603.1.6 1612.4	R105.3.1.1 R324.2.1 R324.1.4	ASCE 24 Sec. 1.5.2 ASCE 24 Sec. 2.5 ASCE 24 Ch. 5 ASCE 24Ch. 7	FEMA 259 FEMA TB #3 FEMA 348
Allowed below BFE but not recommended. Recommendation: Same as V Zone	1603.1.6 1612.4 1612.5.2	R324.2.1 R324.3.2 R323.3.5	ASCE 24 Sec. 4.4 ASCE 24 Sec. 2.5 ASCE 24 Ch. 5	FEMA 55, FEMA TB #8 FEMA TB #5
No requirement			ASCE 24 Sec 4.4	No requirement
Not required, but recommended				
Allowed, but not recommended; if an area is fully enclosed, the enclosure walls must be equipped with openings to equalize hydrostatic pressure; size, location, and covering of openings governed by regulatory requirements.	1203.3.2 1403.5 1612.4 1612.5.1	R324.2.2 R408.7	ASCE 24 Sec. 2.6 ASCE 24 Sec 4.6	FEMA TB #1
NA	1403.5 1403.6 1612.4 1612.5.2	R324.3.4 R324.3.5	ASCE 24Sec. 4.6 ASCE 7 Sec. C5.3.3	FEMA 55 FEMA TB #5, FEMA TB #9
	1403.6 App. G 401.3	R324.1.6	ASCE 24 Sec. 7.3.4	FEMA 348
Requirement: Must be designed, located, and elevated to prevent flood waters from entering and accumulating in components during flooding.	1403.6 1612.4 App. G 701	R324.1.5 IFGC 301, R G2404 R M1601.3.8	ASCE 24 Ch. 7	FEMA 348, FEMA TB #4
CERTIFICATION				
Elevation Certificate	App. G 101.3 App. G 103 App. G 104	R104.2, R105.3.1.1 App. E App. J		FEMA EMI IS-9
MANUFACTURED HOUSING				
	App. G 501	R324.1.8, App. AE101	NA	FEMA 85

Permits and Inspections

4.1 Introduction

This chapter describes the coastal-specific building permit process. In addition to this chapter, the Appendix includes series of resources and checklists that were assembled from processes currently in use around the United States. These processes represent some of the best practices that have successfully guided hazard-resistant design and construction, but this is not meant to imply that they are the only methods of achieving hazard-resistant construction.

To assist in conducting effective and efficient building-permit application reviews, sample organizational structures and a permit-processing flowchart are included. The methods described will assist those working toward the development of an initial building department program or those attempting to improve upon an existing program. Examples of tools and techniques are listed in the Appendix to this guide. No one example is meant to serve as a single solution, nor should it be expected to do so. FEMA is aware that no two jurisdictions will have identical regulatory responsibilities and that the implementation of some processes presented may be the responsibility of one or more officials.

The numerous, complex, and potentially conflicting Federal, state, and local laws, regulations, and ordinances that impact the building permit process can be overwhelming. To successfully interpret and understand the pertinent regulations, this guide presents important regulatory facts, management tools, and organizational techniques to assist in developing or modifying a local permit-processing program.

Establishing effective methods for building application submittals, reviews, and approvals in coastal areas is critical for developing a consistent, thorough, and systematic approach to the processing of these requests. A successful method can be beneficial because it can: (1) ensure that every permit application is properly reviewed and considered; and (2) assist in the development of a rational and efficient way to perform reviews that promote the health, safety, and welfare of the public. The key to how smoothly the coastal development review process flows depends upon how a building department is organized and how well its staff functions. Community members, home builders, and property purchasers must all rely upon the process.

A disorganized system can lead to poorly sited, designed, or constructed buildings. Poor construction typically results in losses that could have been prevented. Community action (taken through a building department) can advance preventive action by rigorously enforcing building codes and other important requirements. These actions can significantly decrease the building damages resulting from coastal storm events. Although it is impossible for property and structures to be completely spared from damages resulting from all high-wind and flooding events, proactive steps can significantly reduce the impact of such devastating storms.

4.2 Coastal Building Official/ Floodplain Administrator's Responsibilities

Whether the local coastal community has appointed a building official and a floodplain administrator or manager (or these roles have been combined into one), it is vital to understand these roles and responsibilities and their respective importance. Any community that adopts a Flood Damage Prevention Ordinance (FDPO) has legally agreed to regulate all significant development activity within the SFHA. In return, property owners may become eligible to apply for Federal flood insurance, disaster assistance, and federally backed loans.

The risk of damage to lives, buildings, and structures is especially acute in coastal areas. Tropical storms, nor easters, and hurricanes produce sustained high winds, wind-driven rains, wave surges, flooding, and severe erosion. Because these fierce storm events pound coastal areas, coastal buildings and structures must be constructed so that they remain serviceable during and after such events.

Coastal construction requires special design considerations and, at times, is based on a particular design event. Building foundations must be constructed to resist flood forces, even when erosion and scour occur. A continuous load path must exist within the structural system to carry all vertical and lateral loads through the foundation and into the ground. The building envelope (which comprises all building surfaces that separate the enclosed floor space from the elements) must resist significant damage and ensure the least amount of penetration by wind, rain, and debris. Floodwater must be prevented from entering occupiable building areas by elevating the structure to a height greater than the expected flood level. Building accessibility and usefulness must be preserved. Special utility connections must either remain intact or be easily restored. Any enclosures constructed below the BFE or DFE must not damage the building's foundation, utility connections, or any elevated building assembly (or part thereof) in the event those enclosures fail.

4.2.1 Enforcement of Regulations

The primary role of the local building official and floodplain administrator is to enforce local regulations. With respect to the NFIP, the lowest floor (including the basements) of all new coastal construction, or all substantial improvements made to that construction, must be located at or above the BFE (or DFE, in some communities). This means that the lowest floor elevation for all new or substantially improved homes in SFHAs within the 100-year floodplains must be elevated at or above this elevation.

4.2.2 Records Management

Local officials are responsible for accurate record keeping and the retaining of all development permits. Two documents are used to record this specific activity: (1) the Floodplain Development Permit (FDP), and (2) the Elevation Certificate (EC) or equivalent elevation documentation. Samples of these forms can be found in the Appendix to this guide. These documents are helpful when completing the FEMA-required Biennial Report, which records statistical information about all flood hazard area changes, all floodplain-development activities, and the number of residents and structures within the floodplain (see Section 4.2.2.1). The NFIP requires the local building official (or other authorized designee) to retain copies of the FDP and records of relevant building elevations. An approved FDP is required for each of the following floodplain-development activities:

- Erecting or enlarging a structure
- Siting a manufactured home
- Mining, dredging, filling, grading, or excavating for major landscaping projects
- Building or repairing roads and bridges in flood hazard areas
- Any human-caused changes in the floodplain, including storage

The permit application form, which is obtained from the building official/floodplain administrator, must be completed and submitted for review and approval before beginning the proposed activity. For FDPs, the local floodplain administrator reviews the permit for completeness and ensures that the development activity fully complies with FDPO requirements. After the review, the permit is either denied or approved. A copy of the completed permit is (and must remain) attached to the building permit.

As part of the National Flood Insurance Act of 1968, both FEMA and states are required to conduct Community Assistance Visits (CAV). During these visits, officials will review a community for compliance with the NFIP and will review records as part of assuring compliance with the program. Following the visit, FEMA and the state will note any compliance problems with the community's program and work with that community in order to remedy the deficiencies.

4.2.2.1 Biennial Reports to FEMA

FEMA periodically sends Biennial Report forms to NFIP-participating communities. These forms are to be completed and returned to FEMA. Community updates of previously submitted data help FEMA and the states plan for technical assistance and flood maps. FEMA is particularly interested in the number of permits issued and the variances granted. Accurate record keeping is essential for a community to properly complete its Biennial Reports.

The EC documents the BFE in comparison to the structure's lowest floor (or the lowest horizontal structural member in V Zones). The EC and a copy of the building permits should be kept together. The EC documents that the structure's lowest floor is above the BFE and that the Flood Damage Prevention Ordinance was followed.

It is important that these documents be maintained in one file or can be easily cross-referenced. Additional data that is important to capture or retain includes a copy of the applicable FIRM panel (including the FIRM panel number and effective date) and the date the building was constructed. This will ensure a record of the compliance of the structure if BFEs change on future FIRM updates. This information should also include requested variances (both accepted and denied), noted violations, and records of citations made to property owners for noncompliance.

In many areas, documents are periodically purged as part of a records-management process. Other storage methods should be evaluated to prevent destruction of building documentation. A lack of proper documentation with respect to structures within the SFHA can impact a community's Community Rating System (CRS) score and, ultimately, its NFIP status.

The following is a brief list of documents that should be included in the permit file:

- Permit Application Form, including all attachments and a site plan
- Correspondence relevant to permit approval or denial
- A copy of a FIRMette at the time of application (including FIRM panel number and effective date)
- Engineering designs that may be required for enclosures below the BFE
 - V Zones: Breakaway Wall Certifications
 - A Zones: Engineered Opening Certifications or manufacturer s documentation
- Engineering calculations for new or substantially improved buildings
- Variances and applicable denial or approval documentation
- Inspection records
- As-built lowest-floor or lowest-horizontal-structural-member documentation (for example, EC)
- Certificate of Compliance or Occupancy

4.2.2.2 Record-keeping requirements:

The I-Codes assert the following specific requirements regarding record keeping:

- Section 104.7 of the IBC requires the keeping of all official records for the period required for retention of public records.
- The NFIP and IBC Appendix G103.8 require that records related to development in flood hazard areas be maintained permanently and that those records remain available for public inspection and review. In addition to retaining permit files, many communities maintain a separate log of permits issued in flood hazard areas.
- Section R.104.7 of the IRC requires retention of official records of applications, permits, and certificates issued; reports of inspections; and notices and orders issued. Such records are to be kept for the period required for retention of public records.

4.2.2.3 Required Documentation

The I-Codes require communities to obtain and retain documentation necessary to determine whether floodplain development activities are compliant with the I-Codes. Requirements include the following:

- Documentation of lowest-floor evaluations (IBC Sections 109.3.3 and 1612.5; Sections R109.1.3 and R324.1.4)

- Documentation of floodproofing (IBC Section 1612.5)
- Documentation of the design of nonstandard flood openings (IBC Section 1612.5)
- In certain circumstances, documentation of breakaway wall design (IBC Section 1612.5; IRC Section R324.3.6)
- Documentation of foundation design, but only in flood hazard areas subject to high-velocity wave action (IBC Section 1612.5, IRC Section R324.3.6)
- Documentation that floodway encroachments will not increase flood levels (IBC Appendix G, Section G103.5). Appendix G applies only if it specifically references this in the local code or ordinance.
- Notifications provided to adjacent communities, the state, and FEMA for watercourse alterations (IBC Appendix G, Section G105.7(5))
- Copies of inspection reports for buildings located in flood hazard areas (IBC Appendix G, Section G103.8; IRC Sections R104.7 and R109.1.3)

NOTE

Many certifications may be required; the following are specific to coastal design and construction projects:

Pile or column certification is required for buildings in SFHAs subject to high-velocity wave action.

Breakaway wall certification is required if design loads are consistent with the values set forth in the code.

Flood opening certification is required if flood openings do not conform to the prescriptive code specifications.

4.2.2.4 Plan Review and Inspection Checklist

Some communities use a checklist during plan review to verify that appropriate flood-resistant provisions have been checked and are acceptable. The sample-plan review checklists in the Appendix to this guide are designed to be transferred to the inspection staff and utilized to document that specific flood-resistant construction details were acceptable. Using a checklist is not an NFIP requirement; however, its use is a sensible way to document plan review and compliance.

4.3 Freeboard

Freeboard (i.e., the additional elevation above the BFE) should be a serious consideration for any community with flooding risks. Incorporating freeboard requirements into a community's regulations can occur either at the state or local level. If the community has adopted ASCE 24-05 as a standard, it should be reviewed in order to make sure that the freeboard requirements within it are followed. Freeboard that exceeds the minimum NFIP requirements can be a valuable tool to the community in maintaining NFIP compliance. Some benefits of freeboard are:

- Lower flood insurance premiums
- Additional protection for events exceeding the predicted 100-year flood event elevation
- Allows for future changes or updates to FIRMs
- Allows for accurate interpretation of flood profiles

- Allows for issues related to surveying benchmarks that may have moved
- Allows for errors in the lowest floor elevation during construction without compromising the BFE
- Allows for changes in water levels due to subsidence or sea level change

Even if a freeboard policy is not instituted, constructing a building to an elevation greater than the BFE will reduce the property owner's flood insurance premium. As of 2009, the IBC will require freeboard. In December 2006, a report titled *Evaluation of the National Flood Insurance Program's Building Standards* was released, which evaluates the benefits of utilizing freeboard. The report is available through FEMA's online library.

4.4 The Pre-development Conference/Pre-application Meeting

There is no substitute for effective communication. Always encourage permit applicants to call or visit building department staff to discuss the development-permit and building-permitting process and requirements before applications are submitted. Such communication establishes an opportunity to ask and answer questions and determine whether a proposal fits that municipality's coastal development guidelines. The processes or modifications shown below may warrant consideration for local programs:

- Inform the applicant if the project will require approval through a planning process. Whenever possible, introduce the applicant to the planning staff. A planning application and fees may be required. Explain how those fees are considered separately from building permit fees. And, if required, inform the applicant how planning approvals must be secured before the applicant is allowed to apply for a building permit.
- Encourage the applicant to discuss the project with the public works department, fire department, and health department (or other relevant agencies) to determine special requirements that may be necessitated by the structure's location within an SFHA. Staff should be prepared to offer suggestions to facilitate the building permit process.
- If there are additional requirements, notify the applicant if the architectural review commission, board of zoning appeals, or planning commission needs to conduct a review of the permit application or drawings. Make known the existence of any Federal, state, regional, or local planning, environmental, and zoning reviews and approvals that may be required before the applicant submits application for a building permit. A flowchart makes the information easier to understand and more likely to be followed. (See Figure 4-1 for a general example of the permitting steps. Modifying the steps may be necessary to make them conform to the local permitting process.)
- Be prepared to answer applicant questions about coastal construction requirements. Keep copies of these regulations available. When possible, assist the applicant in determining where the property is located on the appropriate FIRM map. Verify the flood elevations and explain how this information is incorporated into the DFE. Drawings or illustrations can clearly convey such information. Advise the applicant of the required basic wind speed and explain why this information is critical to the design process.

- To minimize staff time spent answering typical applicant questions, keep an ample supply of informational brochures on permitting requirements available at the permitting counter and post that information on the local Web site. Train your staff to become knowledgeable in these requirements, so that someone is always available to effectively screen walk-in traffic and, if appropriate, provide appropriate guidance to applicants. Also, make a list of outside agencies and department contacts available, complete with names, phone numbers, and e-mail addresses of who should be contacted about particular requirements and procedures.
- When evaluating FIRMs with the client, make clear that the location determination in an SFHA is nearly always based upon the structure location on the map and not on the structure's elevation. The BFE in relation to the actual ground elevation sets the floodplain limits for regulatory purposes. When ground surveys show that a development sits above the BFE, the local official can record the data and issue the permit; then, if the developer or owner wants the property removed from the SFHA designation, a Letter of Map Amendment (LOMA) can be requested. Conversely, if site surveys show that areas considered outside the 100-year floodplain on published maps are, in fact, below the BFE, the local official should require protection of new buildings to the BFE. Although a site may technically be located outside the mapped SFHA, the local official should not ignore the known flood hazard. This may require modifications to the local ordinances in order to make this enforceable.
- It is at this time that many applicants have questions about LOMAs and Letters of Map Revision-Fill (LOMR-F). Explain to the applicant that a LOMA is based upon the elevation of the natural ground of the lowest adjacent grade. A LOMA can be issued for either a structure or a lot, but the advantages and disadvantages of these options should be discussed with the applicant. If fill material will be added, a LOMR-F must be issued. A determination will need to be made for a LOMR-F in order to determine whether the structure will be reasonably safe from flooding, as directed by the NFIP. These map revisions or amendments are intended to correct problems with FIRMs and not to relinquish the responsibility of the property owner to maintain flood insurance.
- Notify applicants requesting significant improvements that the entire structure must be brought into compliance. Refer the applicant to a professional to evaluate the structure and determine whether it is a substantial improvement. (See Section 3.1.1 for a definition of substantial improvement.)
- Because the permit process can be complex, its successful completion depends heavily upon the availability of the local official to dispense clear and concise explanations. This is also an opportune time to suggest hiring the services of a licensed professional, depending upon the project size and type. In fact, the entire project (or portion thereof) may require the professional services of a licensed surveyor, architect, or engineer. Remember that either a registered surveyor or engineer must always determine and certify the 100-year flood elevation of all development applications for new construction or structural additions located within the SFHA.

NOTE

Recent FEMA programs to reissue Flood Insurance Rate Maps have raised the BFE in some areas. Substantial improvements and repairs require the entire structure to be compliant, while minor improvements and repairs require only that the lowest floor be built to the elevation required for the structure when it was initially constructed. An original Elevation Certificate will be required for this.

4.5 Coastal Construction Permit Application Steps

Once a building permit application is submitted, six general processing steps should be followed:

1. Perform initial application review and collect fees.
2. Route the application to other departments/agencies for review and comments.
3. Collect comments and recommendations regarding approvals or denials.
4. Review the application's ability to meet all technical building requirements.
5. Approve or deny the application.
6. Inform the applicant of any appeal process to pursue (if necessary).

Figure 4-1, Permitting Process Overview, illustrates a generic process designed to provide suggestions on possible process modifications.

4.6 Permit Plan Submittal Requirements

The permit application package must include sufficient plan sheets and support documents to allow a complete staff review and analysis during the initial plan check. Under no circumstances should incomplete submittals ever be accepted. Note application deficiencies in such submittals and return them immediately to the applicant for revisions or resubmission. It is the sole responsibility of the applicant to submit a complete application. Using an initial plan-review checklist is recommended to assist in performing the intake review. (See the Appendix to this guide for a sample intake checklist.) Use of a checklist will identify obvious deficiencies that need correction or will confirm that the application is complete and ready for rigorous review.

NOTE

Many communities attach a blank FEMA Elevation Certificate to the issued permit and clearly indicate when (during the process) it must be completed and submitted.

Plan-submittal requirements and packages can vary with each jurisdiction. Requirements can range from a modest single-page report to a lengthy document. All submittals, however, must address coastal development issues, and it is recommended that they include an EC. (See the Appendix to this guide for examples.)

The following situations or conditions may require that certified documents accompany the permit plan:

- **Floodway Encroachment.** If any part of the proposed project will be located in a designated floodway, the applicant must submit an engineering certificate and documentation (e.g., a No-Impact Certificate) demonstrating that the proposed encroachment would result in no increase in base flood heights.
- **Enclosures below the Lowest Floor.** When an applicant designs an enclosure below the lowest floor (using an alternative to the minimum standard for openings prescribed in NFIP requirements), a registered professional architect or engineer must certify the design. (See ASCE 24-05 and FEMA NFIP Technical Bulletin 1: *Openings in Foundation Walls and Walls of Enclosures* (FIA-TB-1) for information on engineered openings.)

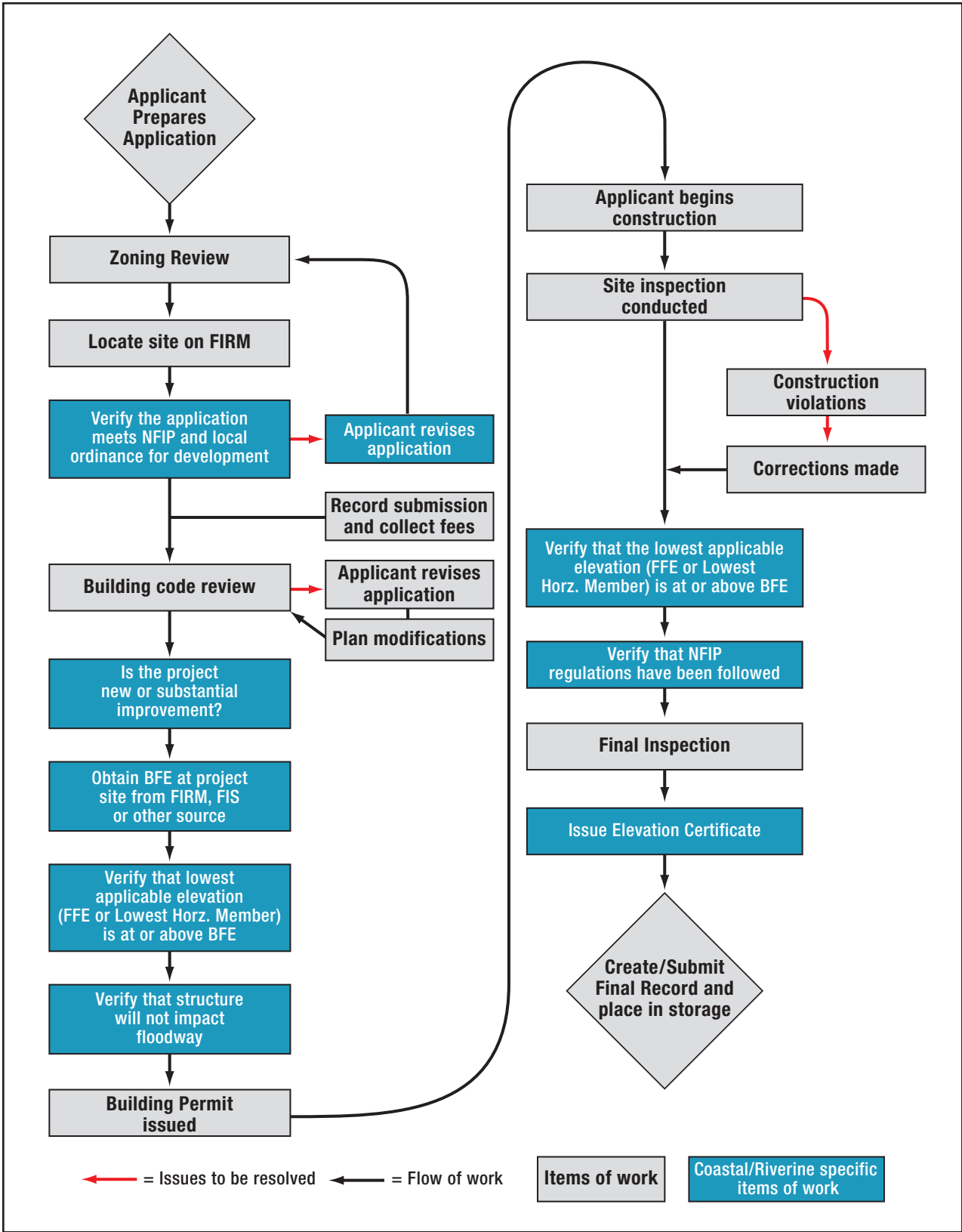

Figure 4-1. Permitting process overview.

- **V Zone Construction.** An applicant proposing to construct a building in a V Zone must supply a statement from a registered professional architect or engineer certifying the design and method of construction of the elevated building and the design of breakaway walls (if the load resistance exceeds 20 pounds per square foot). An as-built certificate is also recommended.

If freeboard has been adopted, verify that the contractor or engineer has submitted plans for a building with the lowest horizontal structural member that is above the DFE.

4.7 Elevation Certificates

Although an Elevation Certificate (EC) is not required to participate in the NFIP, communities are required to maintain records of either the lowest floor elevation or, in V Zones, a record of the lowest horizontal structural member. Communities are encouraged to use the EC, which is required to determine flood insurance rates. ECs are required for a community to participate in the Community Rating System (CRS). After a community's initial date of application, all buildings constructed or substantially improved within the SFHA must have an EC. The lowest floor elevation, or the bottom of the lowest horizontal structural member, is the most significant element in determining whether building construction is compliant with local floodplain management requirements. Certain ground and building elevations are to be surveyed and certified so that building officials can determine the elevation of the lowest floor. A good resource for understanding the certification and documentation of elevations is the *Floodplain Management Bulletin on the Elevation Certificate* (FEMA 467-1).

NOTE

As of January 1, 2007, additional photographs are required with the submittal of an EC. Refer to the FEMA Web site for further direction on what photographs are required for a particular site.

Ideally, elevations are checked when the lowest floor level is set and before further vertical construction takes place. At this point, errors in the elevation can be corrected with minimal cost and delay because the building official's documentation of the lowest floor depends partly upon the location of utilities and final site grading. Documentation of the final elevations must be completed and sealed when that work is finished.

The EC (FEMA Form 81-31, February 2006) is available online in the library section of the FEMA Web site (<http://www.fema.gov/business/nfip/elvinst.shtm>). The form has specific instructions and illustrations for the surveyor/engineer and building official. It is expected that a new version of the EC will become available sometime in early 2009.

Surveyor/Engineer. A registered professional who is licensed to perform elevation surveys is required to complete, sign, and affix a professional seal to the documentation of elevations. The documentation must be dated to indicate when the elevations were surveyed because continuing construction or future modifications could alter and/or outdate the information shown. The registered professional is responsible for obtaining and certifying the accuracy of key ground and building elevations.

Using FEMA-provided diagrams, the registered professional determines which building elevations to survey by selecting the building diagram that most closely represents the actual building. If the diagrams do not match the building configuration, the registered professional may need to note this within the comment section to clarify the diagram selected.

When the required elevations have been surveyed, the local official responsible for NFIP compliance then determines which level is the lowest floor and compares its as-built elevation to the DFE. This comparison determines whether the building is compliant with the elevation provisions of the code ordinance or rules governing local NFIP compliance. If the building is not compliant, enforcement action should be initiated immediately.

In determining the lowest floor, two factors should be kept in mind:

- In A Zones, if an enclosed area below an elevated building has flood openings, incorporates flood-resistant materials, and is used only for parking, building access, or storage, then the floor of that area is not considered the lowest floor. If the structure has a basement, the basement will be considered the lowest floor.
- In V Zones, if an enclosed area beneath an elevated building has breakaway walls, flood-resistant materials, and is used only for parking, building access, or storage, then the floor within the enclosure is not considered the lowest floor.

A copy of the documentation of elevations (for example, the FEMA EC) must be kept in the community's permanent permit file. To facilitate their reporting to FEMA and the state, some communities keep a separate log with information recorded for flood hazard area permits. At a later date, if elevation documentation is not in the file, the community will be required to obtain a replacement to verify the proper administration of NFIP requirements.

4.8 Inspections

Even when building permits and construction plans are complete, good inspection and enforcement procedures are important. Building inspectors, code officers, and floodplain management officials must understand the flood-resistant design and construction requirements they are to check. If deviations from the permit conditions are found early during construction, it is easier to work with the owner and builder to achieve compliance through corrective actions.

Using a plan review and inspection checklist can facilitate inspections because the inspector will have a standardized summary of flood-related requirements that are not seen in non-floodplain buildings. A plan review is also helpful when code enforcement and floodplain management are located in different offices or agencies. A checklist also documents the inspection, which can be crucial to maintaining a community's good standing within the NFIP.

The sections below summarize some of the inspections that can be performed to facilitate compliance with flood-resistant provisions of the code or local ordinance. Note that this list uses DFE. If your community does not use freeboard, then BFE is appropriate to use.

4.8.1 Stake-out or Site Inspection

The best time to verify that a building will be located correctly is during a site inspection, when setbacks and distances from the flood source or body of water can be checked. Checking that the lowest floor is properly elevated is easier if an elevation benchmark or reference mark is located nearby. If one of the reference marks shown on the flood hazard map is not close to the site, placement of a temporary onsite reference mark can make it easier to check the elevation when the floor level is set; a registered professional will certify the elevation when the as-built documentation of elevations is completed.

4.8.2 Fill Inspection

When allowed in SFHAs, fill that is placed to structurally support a building should be inspected for compaction. Compaction reports created during the fill placement monitoring should be collected. It is also important to check that the final elevation of the fill is in line with elevation data included on the permit because it will affect the final elevation of the lowest floor.

4.8.3 Footing or Foundation Inspection

For foundations that will create enclosures below otherwise elevated buildings, inspectors should check for the specified number, size, and location of flood openings. The bottom of each opening shall be no greater than 1 foot above grade and should not be confused with under-floor air ventilation openings, which are located just under the floor level. For slab-on-grade buildings, the lowest floor inspection is conducted at this time. For pile-supported structures, embedment depth and pile plumbness should be checked. In all cases, proper connections between the walls and floor/foundation systems should be checked.

4.8.4 Lowest Floor Inspection (Floodplain Inspection)

Under Sections 109.3.3 of the IBC and R109.1.3 of the IRC, the documentation of the lowest-floor elevation is to be submitted to the building official. An important part of administering provisions for flood-resistant construction is ensuring that buildings are elevated properly. This is required when the lowest floor elevation is set and before further vertical construction takes place. An error of 1 or 2 feet in elevation may seem minor; however, correction can be expensive and complicated if that error is discovered once the walls and roof are in place. In addition, Federal flood insurance is very costly for new buildings constructed with their lowest floors located below the BFE. The Lowest Floor Inspection is also a good opportunity to verify that the mechanical and electrical utilities are to be placed above the BFE.

4.8.5 Final Inspection

A final inspection to document compliance with the floodplain management requirements of the local codes and ordinances can be conducted at the same time as the final inspection that precedes the issuance of the occupancy certificate. During that inspection, it is important to:

- Verify that utilities and other building elements are located properly, usually above the DFE. Frequently overlooked items include heating, cooling, and ventilation equipment; electrical outlets; plumbing fixtures; and ductwork that is installed under the floor, usually within a crawl space.

- In A Zones, inspect enclosures below elevated buildings to ensure that the flood openings are correct in number and to confirm their total net open area and placement. If standard air ventilation units are used as flood vents, the closure mechanism must be permanently disabled so that floodwater can automatically enter and exit freely with no human intervention.
- In V Zones, inspect enclosures below elevated buildings to determine that breakaway walls are constructed to freely break away without causing damage to the building's foundation or the elevated portion of the building. To minimize transfer of loads during flood conditions, utility connections shall not be mounted on (or penetrate through) breakaway walls.
- For enclosed areas below the DFE, check that the approved use (e.g., parking, storage, and building access) appears to be consistent with what has been permitted.
- Check that the exterior fill, when permitted, is placed according to approved plans and specifications.
- Verify that flood-resistant materials are used below the DFE. See FEMA NFIP Technical Bulletin 2: *Flood Damage-Resistant Materials Requirements for Buildings Located in Special Flood Hazard Areas* (FIA-TB-2).
- Examine building utilities to determine if they have been elevated or otherwise installed according to plans to resist flood damage. Heat pumps and pad-mounted air conditioning units must also be elevated at or above the DFE.
- Collect the as-built documentation of elevations before the final sign-off.
- If used, complete and sign the plan review and inspection checklist and place all inspection reports in the permit file.

NOTE

Communities are encouraged to consult with either the NFIP State Coordinator or the appropriate FEMA Regional Office prior to issuing variances. A variance should be carefully considered. Even if allowed by a variance, NFIP flood insurance on a building that is only 1 or 2 feet below the BFE may cost two to three times more than a building in which the lowest floor is located at or above the BFE.

4.8.6 Post-Damage Inspections

After a flood, hurricane, or any natural hazard event that causes significant damage, buildings located in SFHAs and other damaged buildings outside of the SFHAs should be inspected. Some communities distribute flyers explaining permit requirements for reconstruction or repairing buildings and how future flood damage can be reduced during the repair process. Most homeowners do not realize that they may need permits to repair and restore damaged buildings if they are located within SFHAs. Damage that may meet the substantial damage definition must be addressed in accordance with the applicable provisions of the building code and floodplain management ordinance in effect. (See Section 3.6.)

Many tools are available to communities following natural disasters to evaluate damage levels. Buildings need to be evaluated in order to determine whether they are safe to occupy. The Applied Technology Council has issued *ATC-45 Field Manual: Safety Evaluation of Buildings After Wind Storms and Floods* (2004) which provides a methodology for evaluating buildings following a storm event and making a determination on whether they are safe to occupy. More information can be found regarding ATC-45 on the Applied Technology Council Web site (<http://www.atcouncil.org>).

The determination of substantial damage is another decision that needs to be made following storm events. In 1998, FEMA released the Residential Substantial Damage Estimator (RSDE) software to assist local building officials in evaluating homes based upon the performance of 16 building components during a flooding event and expediting the manner in which a substantial damage assessment is conducted. Information on obtaining a copy of the RSDE software and support manuals can be found on the FEMA Web site <http://www.fema.gov>. The National Flood Mitigation Data Collection Tool (NFMDCT) provides a means for cataloging and tracking the substantial damage within a community or jurisdiction and submitting that data.

4.8.7 Coastal and Floodplain Construction Inspector Certification

As part of the ICC's inspection certification program, the ICC has added a certification designation for a certified coastal and floodplain construction inspector, which was specifically developed in order to aid the process of conducting building inspections for coastal areas. This certification focuses on the following areas:

- General construction provisions (e.g., foundations, siting, shear walls, product approvals, erosion, special inspections, and corrosion control)
- Special high-wind provisions and load path continuity
- SFHAs
- Detached and attached accessory structures
- Government regulations

Additional information on obtaining this certification can be found on the ICC Web site at <http://www.iccsafe.org> in the Certification and Testing section.

4.9 Enforcement and Violations

Proper enforcement of floodplain management provisions is a critical part of a community's responsibility under the NFIP. During construction, violations of these provisions must be resolved as soon as they are discovered and before further construction occurs. What may appear to be a minor violation could prove costly when the owner purchases NFIP flood insurance. A community's standing in the NFIP depends upon making a good-faith effort to successfully resolve violations. By allowing any violation to go unresolved, the community may set a precedent, making it more difficult to take future enforcement actions.

Perhaps one of the more persuasive arguments for adopting the I-Codes is that doing so provides an opportunity to consolidate enforcement authority for flood-resistant design and construction provisions. The building department typically has mechanisms in place to aggressively handle code violations, while planning and zoning departments may not.

When the building official and the floodplain manager are located in the same department, care should be taken by the building official and staff to enforce proper permitting requirements on new and improved construction and to verify that ancillary structures on a property are not adversely altering the floodplain. Enforcement of these permits allows local officials to evaluate the potential impacts of such structures and their affect on water flow and drainage within the floodplain.

If a developer or property owner does not comply with the building department's requests for compliance, the permit applicant should first be notified in writing. A notice should be issued on the property if adjustments are not made. The final step in the initial process may include withholding the certificate of occupancy. The following options are available to ensure compliance to the building code and development requirements:

- Fines levied
- Housing Court
- Injunctions against proceeding
- Recordation

It is important that the building official discusses these options with the community's legal counsel before implementing a plan of action. If none of these options yields a positive outcome, the final option is to implement Section 1316 of the National Flood Insurance Act of 1968, as amended. If approved by the FEMA Regional Office, the property will be denied flood insurance. Implementation of Section 1316, however, should be considered only if all other options fail.

4.10 The Variance Process

For purposes of the NFIP, a variance is a grant of relief from the application of the NFIP floodplain management requirements. A variance to the NFIP or local floodplain management requirements allows construction in a manner that is otherwise prohibited and is granted for floodplain management purposes only. A community may issue a variance to allow a building to be constructed in a manner that is at variance to their application of the minimum NFIP provisions via local ordinances; however, NFIP flood insurance will still be rated according to risk and may prove prohibitively expensive.

The primary goals of the flood-resistant provisions of the code are to reduce damage and protect the public health and safety of the entire community. Achieving these goals also results in the creation of disaster-resistant and livable communities. Few variances to the floodplain management provisions can be justified. A variance should not be granted if a proposed activity increases the susceptibility of buildings and people to flooding and flood damage.

As a guiding principle, a variance should pertain to the unique characteristics of the land itself or considerations for historically significant structures. A properly issued variance may be granted for a parcel of land with physical characteristics so unusual that code compliance would create an exceptional hardship for the applicant. A variance should not be granted, however, based upon the personal circumstances of an individual. It is important that the building official maintain records on variance requests along with records of acceptance or denial attached to those requests.

Some variances become necessary because of the presence of historic structures (IBC Section G105.3). If a structure has experienced substantial damage and is unable to be elevated, measures should be taken to mitigate future damage. The building should be repaired using water-resistant materials and, wherever appropriate, utilities should be moved above the DFE to mitigate repetitive losses. Reference guides and materials are available through the FEMA Web site (<http://www.fema.gov>).

4.10.1 Variance Processes as Impacted by the IBC

Section 112 of the IBC requires a board of appeals to hear and decide appeals of orders, decisions, or determinations made by the building official. Specific requirements, considerations, and conditions for issuing variance from floodplain management requirements are found in Appendix G (Section G105) of the IBC.

4.10.2 Variance Processes as Impacted by the IRC

Section R112 requires a board of appeals to hear appeals of orders, decisions, or determinations made by the building official. The board of appeals has specific responsibilities related to flood hazard area development:

- Section R112.2.1. Determination of substantial improvement in areas prone to flooding. Requires that the board of appeals evaluate the building official's finding regarding the value of proposed improvements to existing buildings to determine whether the work constitutes a substantial improvement.
- Section R112.2.2. Criteria for issuance of a variance for areas prone to flooding. Sets forth specific criteria (consistent with minimum NFIP requirements) to be applied during the review and consideration of variances to the minimum flood hazard area criteria.

4.11 Supplemental Information

The Appendix to this guide has sample permits and checklists that will aid in better understanding the process. These samples, with proper modifications, may be used by communities:

- Floodplain Development Permit
- Elevation Certificate
- V Zone Certificate
- Checklist for Permit Review
- Checklist for V Zone Permit Review
- Checklist for V Zone Inspections
- Checklist for A Zone Permit Review
- Checklist for A Zone Inspections

Coastal Construction and Continuous Load Paths

Chapters 1 through 4 describe the natural hazards present in coastal environments, regulations applicable to those hazards, and permitting procedures to ensure that regulations are implemented during the construction process. Chapters 5 through 11 discuss how natural hazards and regulations affect building design and construction

A critical aspect of hazard-resistant construction is the ability of a building or structure to carry and resist all loads—including lateral and uplift loads—from the roof, walls, and other components to the foundation and into the ground. The ability of a building to resist these types of loads depends largely upon whether the building's construction provides a continuous load path.

The discussion in this chapter focuses on wind loads; however, the same principles apply to other events (such as earthquakes) that create loads on buildings. Section 2.2 of FEMA 232 contains an excellent discussion of the load path continuity required to resist seismic events.

The location of continuous load path components is also important, particularly for those components that resist lateral loads. Ideally, such components should be located symmetrically with the footprint of the structure. This may require buildings to be designed rectangular in plan or constructed with rectangular sections. The proper use of rectangular elements reduces plan irregularities and minimizes the development of torsional (i.e., twisting) forces within the building. Torsional forces can overload structural elements or cause excessive deflection that can damage non-structural building components. Torsional loading and plan irregularities are complex issues beyond the scope of this guide. (See FEMA 232 for guidance on those issues.)

NOTE

For coastal buildings, wind and flood events will produce lateral loads that must be resisted. Seismic events also produce laterally induced loads through the structure. Complex floor plans and irregularities in the building structure may compound these forces. See FEMA 232 for guidance on seismic-resistant designs for homebuilders.

5.1 Continuous Load Path

The term *continuous load path* describes the structural condition required to resist loads acting on a building. A building may contain hundreds of continuous load paths. The continuous load path starts at the point or surface where loads are applied, then moves through the building itself, continues through the foundation, and terminates where the loads are finally transferred to the soils that support the building. FEMA 55 describes a continuous load path as a type of chain whose links consist of the members and connections that make up a building. As with any chain, a continuous load path is only as strong as its weakest link. Buildings lacking strong and continuous load paths may fail when exposed to forces from coastal hazards, thus causing a breach within the building envelope or even the total collapse of such buildings.

Continuous load paths are important in all buildings. In coastal construction, where wind loads are higher and flood loads exist, paying proper attention to continuous load paths is crucial for ensuring building survival.

The history of past storm damage is replete with instances of failures in load paths (see Figures 5-1 through 5-5). Repeatedly, buildings constructed along the coast have failed when their load paths were not strong enough to withstand the forces exerted upon them. Most load path failures have been observed at connections, as opposed to failure of the individual members themselves. Fortunately, as building codes and standards improve, the knowledge of load paths increases and older buildings are either improved or replaced. As a result, load path failures are becoming less frequent.

As structural systems perform better, other issues related to load path construction become evident. Recent post-disaster damage investigations have revealed performance issues in building envelopes. Chapters 8, 9, and 10 present detailed discussions on building envelope performance for roofs, wall systems, and openings.



Figure 5-1.
DADE COUNTY, FLORIDA, HURRICANE ANDREW (1992): Second-story wood framing (on first-story masonry). Load path failure at end gable. (Source: FEMA 55)



Figure 5-2.
NORTH CAROLINA, HURRICANE FRAN (1996): Load path failure in connections between home and its foundation. (Source: FEMA 55)



Figure 5-3.
PUNTA GORDA, FLORIDA:
Roof framing damage and loss due
to load path failure at top of wall/roof
structure connection.
(Source: FEMA 488)



Figure 5-4.
PUNTA GORDA, FLORIDA:
Load path failure in connections
between roof decking and
roof framing.
(Source: FEMA 488)



Figure 5-5.
PASS CHRISTIAN, MISSISSIPPI:
Newer home damaged from
internal pressurization and
inadequate connections.
 (Source: FEMA 549)

NOTE

FEMA 499 (*Home Builder's Guide to Coastal Construction – Technical Fact Sheet No. 10, Load Paths*) provides information and descriptions of continuous load paths.

5.2 Types of Load Paths

Load paths run from the point (or surface) where loads are applied (see Figure 5-6) through building to the foundation, where they are transferred to the soil. In a building, the path that loads follow (i.e., from where they are applied to the structure down to the foundation) depends upon many factors, such as load sharing, load distribution, and building stiffness. While load paths are complex, designers consider them in categories of vertical or horizontal paths (see Figure 5-7 and 5-8). Most designers, builders, and homeowners understand that downward gravity forces must be resisted by vertical load paths. Vertical load paths must also resist uplift forces from flood, wind, or seismic events. Large uplift forces may be the result of flood loads from buoyancy, from breaking waves hitting horizontal surfaces (such as decks or the undersides of buildings), or from wind acting on all sides of a building. Horizontal load paths, like vertical load paths, transfer lateral loads from wind, flood, and seismic events into the ground.

A schematic example of a complete load path (see Figures 5-7 and 5-8) shows the chain of connections from the roof to the foundation; these connections were designed and constructed to resist lateral and uplift forces from a wind event. The load path consists of fasteners securing the roof covering (such as roof shingles and metal roofing) to the roof deck; nails or screws securing the roof deck to the roof framing; metal anchors securing the roof framing to the wall's top plate; wall sheathing or metal straps securing the wall's top plate to wall studs; and the wall stud secured to the bottom plate (or sill plate). The load path continues with anchor bolts securing the foundation bottom plate to the main floor beams and then to the pile foundation, in order to account for all vertical and lateral loads.

All loads applied to a structure must be transferred to the foundation of the building and, finally, the ground. It is important to remember:

- Loads acting on a building follow many paths through the building and must eventually be resisted by the ground. Otherwise, the building may fail during an event.
- Loads accumulate as they are routed through key connections in a building.
- Member connections are usually the weak links within a load path.
- Failed or missed connections cause loads to be rerouted through unintended load paths, often resulting in building damage or collapse.

Failure to adequately maintain a proper load path has been observed where building elements failed after hurricanes. (For example, fasteners were commonly spaced too far apart, were too small, or had weak connections.) Numerous examples showing failures to follow well-established basic construction practices exist, such as ensuring minimum edge distances for fasteners.

Figures 5-7 and 5-8 show a complete load path and identify what to look for when evaluating plans or inspecting framing and what building inspection points to address. Each link is important and must be considered by the engineer or designer. Even with a good design, however, unsatisfactory construction of the structure will exert the most impact on the building's performance during a storm event. If the construction is not completed in accordance with codes, plans, and drawings, the entire structure remains at risk. Specific details related to foundations, building framing, and the building envelope are discussed in following chapters.

5.3 Identifying Load Paths in Buildings

It is important to identify both vertical and horizontal load paths in the building designs and during construction of the building. (Vertical load paths were discussed in Section 5.2.)

Horizontal load paths consist of structural elements that transfer horizontal (or lateral) loads through the building to the foundation. Horizontal load paths in a typical one- or two-family dwelling consist of exterior siding that transfers loads to wall sheathing; wall sheathing that transfers loads to wall framing; wall framing that transfers loads to horizontal roof and floor diaphragms; and horizontal diaphragms that transfer horizontal loads to the foundations through vertical shear walls and their shear wall tie-downs.

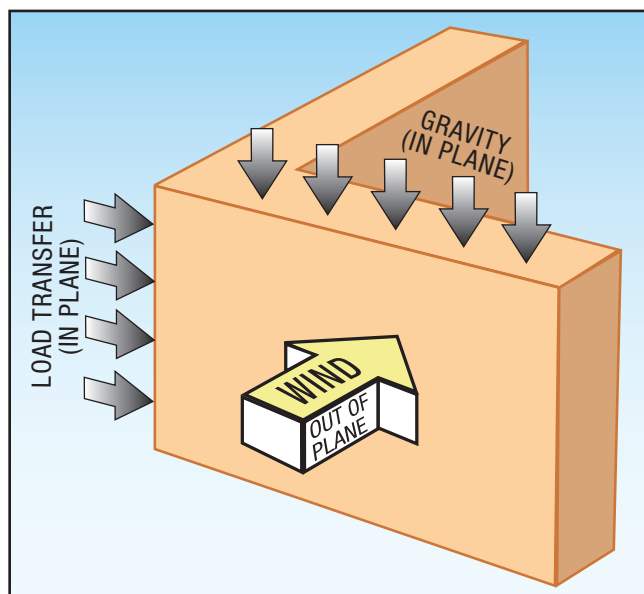

Figure 5-6.
Loads applied to the exterior wall of a building.

Load Paths



FEMA



HOME BUILDER'S GUIDE TO COASTAL CONSTRUCTION FEMA 499/August 2005 **Technical Fact Sheet No. 10**

Purpose: To illustrate the concept of load paths and highlight important connections in a wind uplift load path.

Key Issues

- Loads acting on a building follow many paths through the building and must eventually be resisted by the ground, or the building will fail.
- Loads accumulate as they are routed through key connections in a building.
- Member connections are usually the weak link in a load path.
- Failed or missed connections cause loads to be rerouted through unintended load paths.

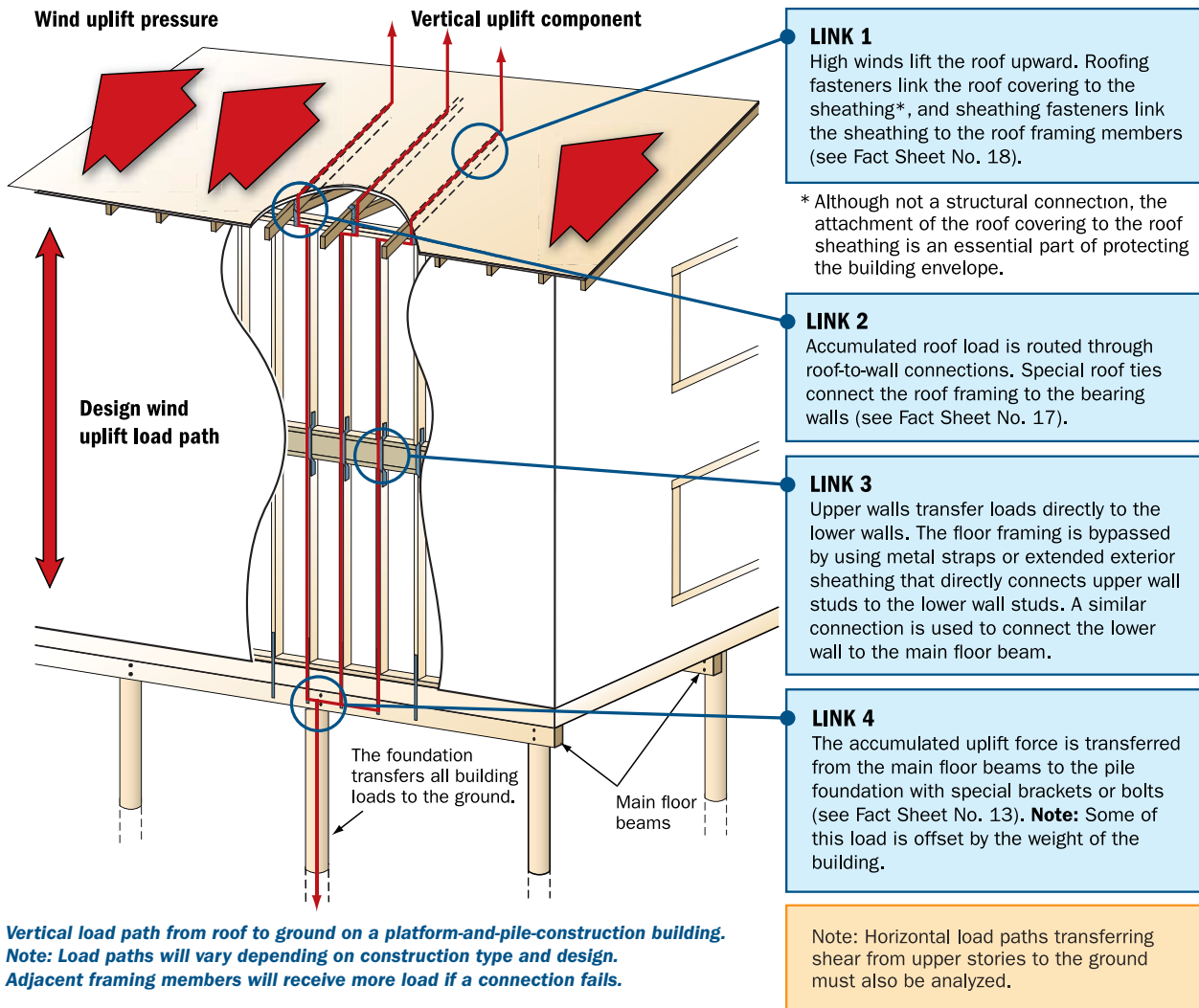

Vertical load path from roof to ground on a platform-and-pile-construction building.
Note: Load paths will vary depending on construction type and design. Adjacent framing members will receive more load if a connection fails.

Figure 5-7.
 Technical Fact Sheet No. 10, Page 1. For more information on load paths and load transfer, see Chapter 7.
 (Source: FEMA 499)

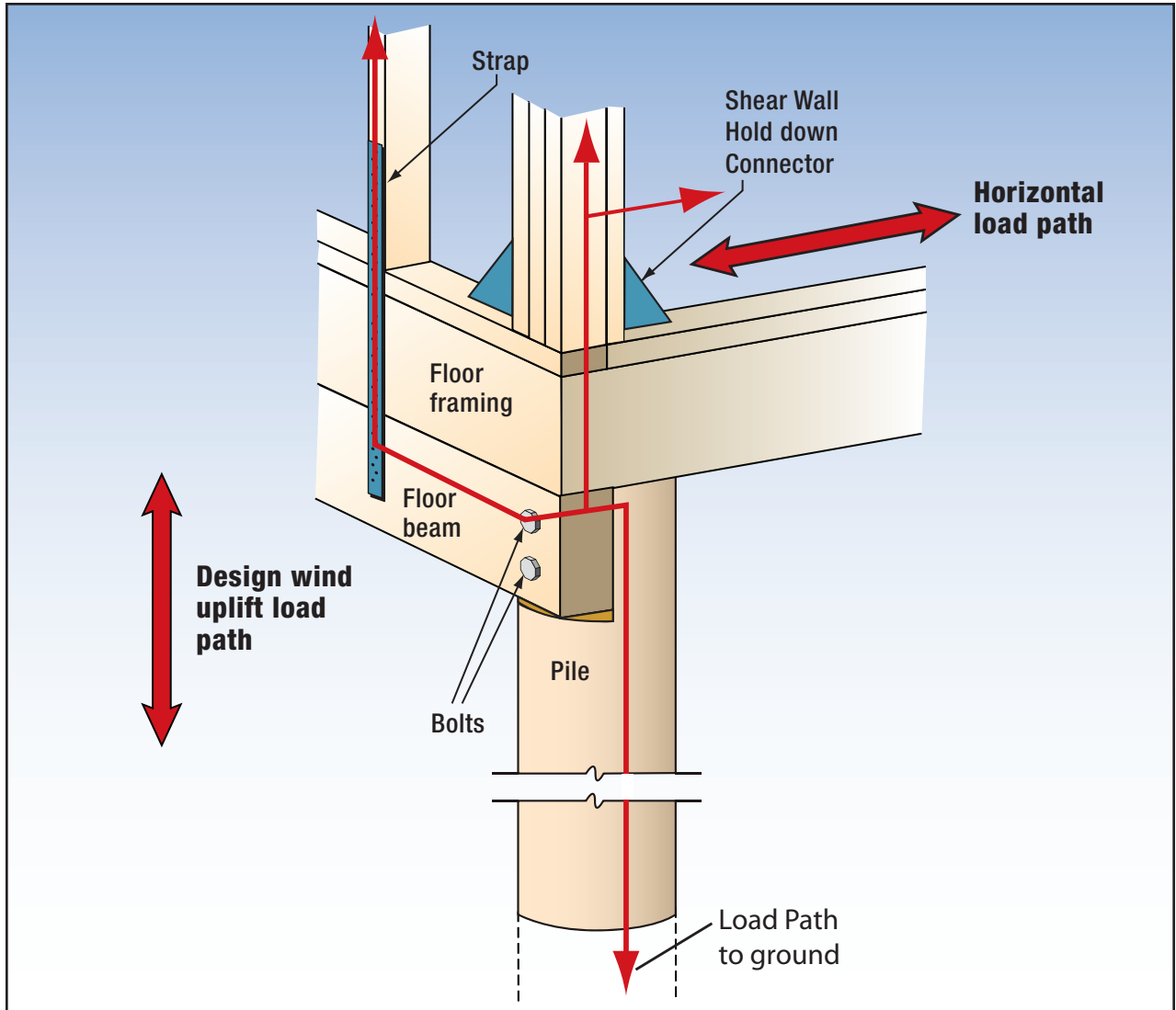

Figure 5-8.
 Technical Fact Sheet No. 10, Page 2. (Source: FEMA 499)

5.4 Building Codes and Standards

The importance of continuous (or complete) load paths is clear in building codes and standards. Section R301.1 of the International Residential Code (IRC) states:

Buildings and structures, and all parts thereof, shall be constructed to safely support all loads, including dead loads, live loads, roof loads, flood loads, snow loads, wind loads, and seismic loads as prescribed by this code. The construction of buildings and structures in accordance with the provisions of this code shall result in a system that provides a complete load path that meets all requirements for the transfer of all loads from their point of origin through the load-resisting elements to the foundation. Buildings and structures constructed as prescribed by this code are deemed to comply with the requirements of this section.

The IRC has specific design requirements for many points within the load paths of buildings for certain basic wind speeds. These requirements can be used by designers, builders, and code officials to select connectors and size framing members. Because the prescriptive designs of the IRC are limited to 110-mph wind speeds, other standards (such as *SSTD-10, Standard for Hurricane Resistant Residential Construction*, the International Code Council's ICC-600, or the American Forest and Paper Association's (AF&PA) *Wood Frame Construction Manual*) can be used to identify prescriptive solutions and construction details in areas with higher basic wind speeds.

The IRC (and Chapter 23 of the IBC) has prescriptive shear wall and shear wall tie-down requirements for conventional construction as an alternative to performance-based design (that is, buildings with lateral-force-resisting systems consisting of horizontal diaphragms and shear walls). For buildings constructed with steel or reinforced concrete frames or other lateral-force-resisting systems, the IBC has performance requirements that engineers and architects use to design a structure's lateral-force-resisting system.

The prescribed loads discussed above in the IRC generally address wind and seismic loads that must be considered during design. In coastal areas, homes are often exposed to flood loads, which can include those from breaking waves, hydrostatic loads, hydrodynamic loads, and loads from floodborne debris. Individuals responsible for plan review should be aware of this limitation to ensure that all loads are being properly considered during building design. Few consensus codes or standards have prescriptive flood-resistant designs. FEMA 550 (*Recommended Residential Construction for the Gulf Coast: Building on Strong and Safe Foundations*), contains designs for several styles of foundations suitable for coastal sites and guidance for engineers in designing custom flood- and wind-resistant foundations.

Similar requirements exist in Section 1604.4 of the IBC:

*...shall result in a system that provides a **complete load path** capable of transferring loads from their point of origin to the load-resisting elements.*

SSTD 10 (the prescriptive high-wind standard for residential construction), also requires load path continuity, as does ICC-600, *Standard for Residential Construction in High-Wind Regions*.

5.5 Continuous Load Paths and Building Success

Post-event assessments reveal how constructing buildings with strong and continuous load paths can enable structures to survive even when exposed to hurricane-force winds.

For the construction of a coastal building to be considered a success, the building should meet four conditions:

- It must be designed to withstand anticipated forces and conditions.
- It must be constructed as designed.
- It must be elevated to avoid floodwaters and flood forces.
- Its envelope must protect the habitable areas of the structure.

The designer should only use connections to their published lateral/uplift tested values. If the connection only has a tested uplift value, use another connection that has been tested for the appropriate lateral forces or utilize a designed alternative to resist forces.



Figure 5-9.
BIG LAGOON, FLORIDA:
Elevated building (constructed
to newer code) that
survived Hurricane Ivan.
(Source: FEMA 489)



Figure 5-10.
BIG LAGOON, FLORIDA:
This house was elevated on
piles, preventing severe damage
from coastal flooding.
(Source: FEMA 489)



Figure 5-11.
BIG LAGOON, FLORIDA:
This house was elevated on piles,
preventing major flood damage.
(Source: FEMA 489)

Coastal Foundations and Best Practices

6.1 Introduction

A building's foundation is arguably its most important structural element. Despite its particular location, a foundation must support the building above it and all the loads that are exerted on it. It must adequately transfer loads acting on the structure to the supporting soils and must resist weathering, decay, and corrosion (with little or no maintenance) in order to remain viable for the entire life of the building. The foundation must perform all of these functions while being exposed to the damaging effects and conditions present in a coastal environment. These effects include erosion and scour, breaking waves and moving floodwaters, and the potentially disastrous effects of floodborne debris. Coastal foundations must, therefore, be stronger, better planned and designed, and more solidly constructed than inland foundations.

In inland areas where wind and seismic loads often control the design, the criteria for foundations are well-defined and easily understood by engineers, architects, builders, and building officials. Codes such as the IBC and the IRC (and their predecessors) have for decades provided detailed requirements for foundations and prescriptive foundation designs for many structures. In coastal areas, however, this has not been true.

While wind and seismic criteria have long been established, flood criteria are newer and have appeared only recently in performance-based consensus codes and standards. The flood provisions of ASCE 7 first appeared in the 1995 edition of that standard. Similarly, the consensus standard ASCE 24 was first issued in 1998. Because the origination of flood provisions in performance codes and standards has occurred relatively recently, flood designs have yet to make their way into prescriptive codes and standards. No consensus-based, off-the-shelf, flood-resistant designs that fully address construction in coastal areas currently exist. Documents such as FEMA 259 and FEMA 550 provide prescriptive design guidance for foundations. FEMA 499, Technical Fact Sheets No. 11 (*Foundations in Coastal Areas*), No. 12 (*Pile Installation*), and No.13 (*Wood Pile-to-Beam Connections*) also provide appropriate guidance.

Some aspects of coastal environments, such as scour and erosion, have not been researched to the point that consensus codes or standards have been developed on these topics. Decisions regarding some coastal issues (e.g., scour and erosion) may need to be based primarily on judgment from local design professionals or published guidance, or on historical data and trends. In the absence of more definitive data, decisions may need to be based solely on local experience.

6.2 Building Codes and Coastal Foundations

Coastal construction is regulated in several IBC sections. IBC Section 1603.1.6 requires that when a home is located within a SFHA, information on local flood conditions and elevations must be specified in the construction documents. When a home is sited in an area subject to high-velocity wave action (i.e., a V Zone), the IBC also requires that the proposed elevation of the lowest horizontal structural member be specified. IBC Section 1612.4 requires that homes in high-velocity wave action zones be designed in accordance with ASCE 24-05, which requires that foundations be constructed to resist all flood forces exerted on them; remain free of obstructions or attachments that will transfer forces to the structural system or that will restrict or eliminate free passage of high-velocity floodwaters and waves ; and be constructed of flood-resistant materials. ASCE 24-05 requires that structures in areas subject to high-velocity wave action be supported on piles, columns, or shear walls. Shallow mat or raft foundations may be used only when the tops of those foundations are placed below the estimated maximum-eroded ground surface. ASCE 24-05 also specifies freeboard (that is, requires structures to be elevated above the NFIP-mandated requirements). The amount of freeboard depends upon the importance of the building and the orientation of the building's structural elements in relationship to incoming waves. ASCE 24-05 freeboard requirements generally vary between 1 and 2 feet.

IBC Section 1612.5(2) also requires that V Zone construction design documents include a statement that the building is designed in accordance with ASCE 24 and that the building or structure to be attached thereto is designed to be anchored to resist flotation, collapse, and lateral movement due to the effects of wind and flood loads acting simultaneously on all building components, and other load requirements of Chapter 16. This provision may require architects or engineers to design the foundation for buildings located within V Zones.

The IRC requirements are similar but somewhat less stringent than those of the IBC. IRC Section R324 requires that homes be elevated and anchored to resist flotation, collapse, and lateral movement; IRC Section R324.3.6 requires that design professionals prepare construction documents stating that the design and construction methods satisfy the flood provisions of the IRC. The freeboard requirements of ASCE 24-05, however, are invoked only when a home is placed within a floodway. As a best practices approach, the freeboard requirements of ASCE 24-05 should be met for all coastal construction (both residential and non-residential).

6.3 Constructing Foundations in Coastal Areas

Building in coastal environments poses unique challenges:

- The effects of storm surge, wave action, and erosion make coastal flooding more damaging than inland flooding.
- Buildings are often required to be elevated higher than they would be in inland sites to avoid flooding and wave action, particularly in areas where storm surge can inflict severe damage on the buildings.
- Foundations are exposed to damaging floodborne debris that results when floodwaters destroy older or weaker buildings and coastal structures.

NOTE

For information on Coastal A Zones, see Chapter 2 of this guide or Chapter 12 of FEMA 55.

- Erosion and scour can undermine foundations, thus causing buildings to fail.
- Basic (design) wind speeds are typically greater in coastal areas than in inland areas and require buildings (and their foundations) to be stronger in order to resist those greater loads.

In coastal environments, code-compliant foundations must be designed and constructed:

- To elevate the building high enough to avoid flooding.
- To be strong enough to resist all loads expected to act on the building and its foundation during a design event.
- To satisfy the minimum requirements of the NFIP and any state or local floodplain management conditions.
- To prevent flotation, collapse, and lateral movement of the building.
- With flood-resistant materials at or below the BFE (or DFE, in areas where the use of freeboard is mandated)
- So that the lowest floor (in A Zones) or the bottoms of the lowest horizontal structural members (in V Zones) are elevated above the BFE/DFE
- To accommodate expected scour and erosion throughout the life of the structure

NOTE

Some coastal areas mapped as A Zones may be subject to damaging waves and erosion. ASCE 24-05 defines Coastal A Zones as areas landward of V Zones or areas landward of an open coast, where breaking-wave heights may exceed 1.5 feet. (The V Zone/A Zone boundary on Flood Insurance Rate Maps denotes areas where design-event breaking-wave heights reach 3 feet. When the wave is 3 feet high or higher, this area is mapped as a V Zone, while areas with waves less than 3 feet high are mapped as A Zones.)

The NFIP allows conventional foundations (that is, shallow, closed foundations equipped with flood-equalizing vents) in Coastal A Zones; however, evaluations conducted after numerous hurricanes confirm that NFIP-allowed conventional foundations often fail when exposed to breaking waves or when undermined by erosion. Because of this, V Zone construction is recommended for Coastal A Zones. As discussed in Chapter 3 of this guide, V Zone construction involves placing structures on deep, open foundations that elevate the lowest horizontal structural member of the building above the BFE or DFE (see Figure 6-1). Figures 6-2 and 6-3 show examples of building failure in an area where Coastal A Zone conditions likely existed.

The inland extent of a Coastal A Zone is the line where a design flood event can create a 1.5-foot-high breaking wave and is identified on newer FIRM panels with a line different from the flood hazard boundary line; this line is called the Limit of Moderate Wave Action (LiMWA). (That boundary is delineated where stillwater depths equal approximately 2 feet.) Breaking waves at that boundary can destroy concrete or masonry foundation walls that lack adequate reinforcement to resist wave loads from those relatively short-breaking waves.

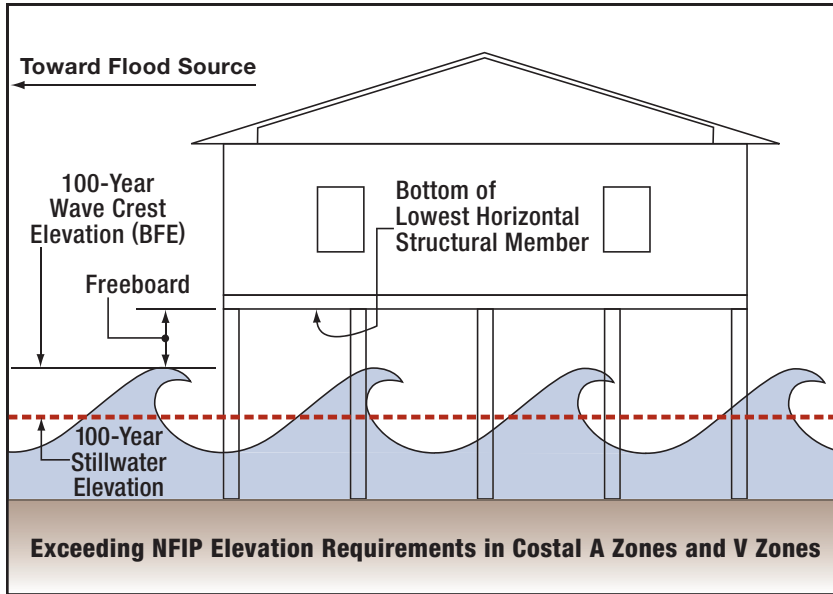

Figure 6-1. Recommended open-foundation practice for buildings located within the Coastal A Zone and V Zone. (Source: FEMA 55)



Figure 6-2. NAVARRE BEACH, FLORIDA: Slab-on-grade foundation failure due to erosion and scour undermining. (Source: FEMA 489)



Figure 6-3.
NAVARRE BEACH, FLORIDA:
Close-up of foundation failure
shown in Figure 6-2.
(Source: FEMA 489)

6.4 Elevating Buildings in Coastal Areas

Buildings in coastal areas may be elevated in many ways. Homes can be elevated on fill, constructed with closed foundations (for example, crawlspace foundations, stem wall foundations, or slab-on-grade foundations), or constructed on open foundations (using piers, pilings, or columns). Not all elevation methods, however, are suitable for all coastal areas. In fact, several methods are prohibited in V Zones, while some methods are allowed but not recommended for use within other coastal areas. This section discusses the foundation types used to elevate buildings and the acceptability of each style within a coastal area.

6.4.1 Elevation on Fill

Before building on a site within an SFHA, the site itself can be elevated with fill (see Figure 6-4). Fill can elevate a site above the BFE and thus release the builder from having to comply with certain NFIP construction requirements. Alternatively, fill may be used to partially elevate the site and allow shorter NFIP-compliant foundations to be used. Shorter foundations improve building accessibility and are often desirable for the elderly, handicapped, or others with physical challenges.

Because fill is susceptible to erosion, it is not always the best option to mitigate flood hazards. Its use is prohibited as a means of providing structural support to buildings in V Zones and is not recommended in Coastal A Zones. Fill may not be used as a means of elevating buildings in coastal areas subject to erosion, waves, or fast-moving water.



Figure 6-4.
PLAQUEMINES PARISH, LOUISIANA:
 Home that had been elevated
 on fill, during the aftermath
 of Hurricane Katrina.
 (Source: FEMA 549)

6.4.2 Closed Foundations

A closed foundation typically consists of continuous perimeter foundation walls. Because these walls enclose areas within solid perimeter walls, this is often referred to as a closed foundation. A closed foundation can be a crawlspace foundation, a stem wall foundation (usually filled with compacted soil), or a slab-on-grade (or monolithic) foundation.

A closed foundation obstructs floodwaters and does not allow water to pass easily through a foundation. Closed foundations also present large surface areas upon which waves and flood forces can act. Because of their vulnerability to breaking waves, the use of closed foundations is prohibited within V Zones and is not recommended within Coastal A Zones.

NOTE

Although the NFIP permits closed foundations in A Zones, they are not recommended in Coastal A Zones. The walls of these foundations will be exposed to large forces from waves and fast-moving waters and may exacerbate scour at the building site.

Properly designed and constructed closed foundations are suitable for SFHAs where the heights of breaking waves are less than 1.5 feet (i.e., non-coastal A Zones). In these instances, the foundation walls must be equipped with openings that allow water to enter the area enclosed by the walls. The openings are necessary to keep unbalanced loads from occurring due to the presence of floodwaters outside the walls (and not inside them). The openings allow water to enter and exit the area behind the foundation. The flow of floodwater into and out of the foundation equalizes water on both sides of the wall. This equalization significantly reduces lateral hydrostatic forces on the walls. FEMA 499, Technical Fact Sheet No. 15, *Foundation Walls*, and FEMA NFIP Technical Bulletin 1: *Openings in Foundation Walls and Walls of Enclosures* (FIA-TB-1), contain information on flood openings for closed foundations.

As with any foundation, closed foundations must adequately support the structure above and transfer loads acting on the elevated building and the foundation to the soil below. In non-coastal environments, wind (or seismic) and gravity loads typically dominate and control foundation design. In coastal environments, flood loads must also be addressed.

Wind loads are transferred through a structure via properly designed and constructed vertical and horizontal load paths. Particular attention should be given where the building attaches to the foundation; the loads created by the wind acting on the roof and walls must be transferred through the building into the foundation and into the ground. For residential construction, connections to resist uplift and shear wall reactions from wind forces are detailed in prescriptive codes and standards such as the IRC, AF&PA's *Wood Frame Construction Manual*, and ICC-600, *Standard for Residential Construction in High-Wind Regions*.

Foundations designed for wind only may lack the strength required to resist flood loads. While wind-resistant foundation designs are prevalent, prescriptive flood- and wind-resistant designs are less available. FEMA 550 is a guidance document which presents many wind- and flood-resistant designs.

For short foundation walls (i.e., those 3 feet high or less) that do not retain backfilled soils, reinforcement may be necessary in order to construct a foundation wall. It should be considered that the reinforcing necessary to resist a 1.5-foot-high breaking wave is comparable to that required to resist wind loads of 120 mph. However, taller foundation walls need additional reinforcement to resist breaking-wave loads. For example, 8-foot-high walls may require the placement of vertical reinforcing steel within masonry walls, with a spacing of 16 inches on center. FEMA 550 contains designs for closed foundations that can resist wind loads and flood loads from 1.5-foot-high breaking waves.

6.4.2.1 Crawlspace Foundations

Crawlspace foundations typically consist of perimeter masonry or concrete foundation walls and a system of interior beams and piers that support an elevated floor framing system. In permanent wood foundations, the perimeter walls are framed with preservative-treated wood framing and sheathing. Elevated floors are typically wood-framed, but they may also be constructed of concrete. This section discusses crawlspace foundations on closed foundation walls. (See Subsection 6.4.3.2 for a discussion on open crawlspace foundations.)

In many instances, crawlspaces are used as a location for mechanical equipment (such as ductwork and piping), and the floor framing is typically constructed of wood. If mechanical equipment is installed in the crawlspace, precautions should be taken in order to make sure that the ductwork is located above the BFE in order to maintain NFIP compliance.

Closed-wall crawlspace foundations are usually constructed on relatively shallow, cast-in-place concrete footings, where the depth of the footing is dictated by the local frost depth. Because closed-wall crawlspace foundations are shallow, they are vulnerable to being undermined from erosion and scour and are not recommended for use within Coastal A Zones. Because closed-wall crawlspace foundations are vulnerable to breaking waves, the NFIP prohibits their use within V Zones. Figures 6-5 and 6-6 illustrate the vulnerability of closed-wall crawlspace foundations within a V Zone.

The NFIP requires flood openings in crawlspace foundations constructed within SFHAs. A minimum of two openings (having a total net area of not less than 1 square inch for each square foot of enclosed area subject to flooding) shall be provided. To remain effective, the NFIP requires that the bottoms of flood openings be placed within 1 foot of grade; this limits lateral forces on foundation walls. (FEMA 499 Technical Fact Sheets No. 15, *Foundation Walls*, and No. 27, *Enclosures and Breakaway Walls*, contain guidance on flood openings.)



Figure 6-5.
Building failure caused by undermining of crawlspace foundation during Hurricane Fran. Breaking waves may also have contributed to foundation failure. (Source: FEMA 290)



Figure 6-6.
Failure of crawlspace foundation undermined by scour. (Source: FEMA 290)

Flood openings can rarely, if ever, be used for air ventilation and humidity control. Vents for humidity control are typically most effective at preventing condensation on vulnerable floor framing when they are installed high within the crawlspace; such placement is not effective for protecting foundation walls from damaging flood loads. Vents with combined purposes should be inspected to verify their proper positioning.

NOTE

FEMA 550 has prescriptive designs for crawlspace foundations up to 8 feet high for Exposure C design-wind speeds of up to 150 mph.

A recent trend involves the use of conditioned crawlspaces for temperature and humidity control. To prove effective (and to avoid exacerbating moisture problems), crawlspaces must be completely sealed to prevent migration of exterior humidity into the space. They must also be insulated to control cold areas, where condensation can form. Properly conditioning crawlspaces is a complex undertaking. Because they must be completely sealed for effective conditioning, conditioned crawlspaces should not be used within SFHAs unless the NFIP-required flood vents adequately seal the space while remaining able to open under the pressure exerted by floodwaters. Also, the NFIP requires that any material placed below the BFE (or DFE) be flood-resistant, thus precluding the use of many types of insulation.

6.4.2.2 Stem Wall Foundations

Stem wall foundations are similar to crawlspace foundations. They consist of perimeter foundation walls (typically masonry or concrete), but the interior space that would otherwise form the crawlspace is backfilled with soils that support a floor slab. In the Gulf Coast region, these foundations are often referred to as chain walls. Figure 6-7 shows a cross section of a typical stem wall foundation.

Anecdotal evidence suggests that during flood events stem wall foundations have performed better than many crawlspace foundations. However, it is important to note that the prescriptive designs set forth in the building codes often limit stem wall height to just a few feet. While higher stem wall foundations can be designed, the cost of suitable fill and proper fill placement often makes their use impractical. The use of stem wall foundations is prohibited within V Zones and is not recommended for use within Coastal A Zones; however, their use is appropriate within A Zones where wave heights are 1.5 feet or less and where footings are deep enough to resist scour and erosion.

Stem wall foundations do not require vents to equalize the pressures exhibited by floodwaters. They do, however, need to be strong enough to resist lateral pressure from retained soils. Because the retained soils can become saturated during a flood event, additional reinforcement is typically needed.

FEMA 550 has prescriptive flood- and wind-resistant designs for stem wall foundations. Designs are provided for two types of walls: cantilevered and laterally supported. In cantilevered walls, reinforcing steel provides sufficient strength to resist lateral forces without relying on the floor slab to laterally support the top of the wall. In laterally supported walls, the top of the wall is tied to the floor slab; the typical result is that less vertical reinforcement is needed in the foundation. Laterally supported walls must be braced to prevent movement or collapse when backfilling.

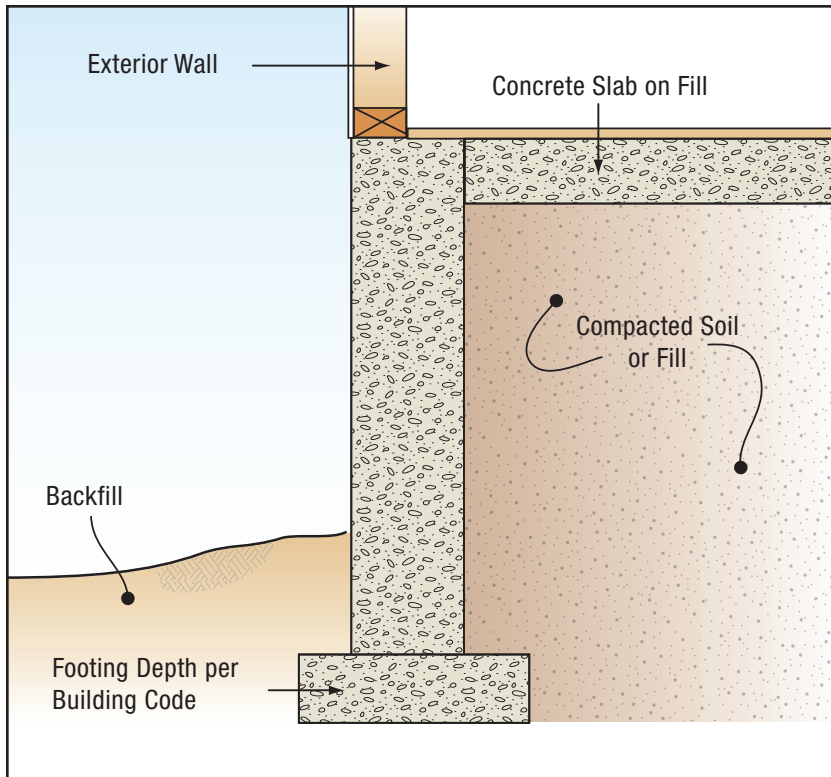

Figure 6-7.
Typical stem wall foundation.
(Source: FEMA 543)

6.4.2.3 Slab-on-Grade Foundations

Slab-on-grade foundations are similar to stem wall foundations. Like stem wall foundations, the floor consists of a concrete-grade slab. Unlike stem wall foundations, however, slab-on-grade foundations do not have a true perimeter foundation wall, but instead have thickened portions of the slab that function as footers for the exterior walls and interior bearing walls.

In many areas, slab-on-grade foundations are the most cost-effective type of foundation. In an SFHA, however, their use carries limitations. From a practical standpoint, they can only be used to elevate a building 1 foot or less (higher elevations require large quantities of concrete). Therefore, where flood depths exceed 1 foot, the use of other foundations should be considered. Slab-on-grade foundations can be used in conjunction with properly placed and compacted fill.

Slab-on-grade foundations are shallow foundations that are susceptible to being undermined by scour and erosion. The use of slab-on-grade foundations is prohibited within V Zones and is not recommended for Coastal A Zones. (Note that parking slabs are often permitted below elevated buildings in V Zones, but they are recommended to be frangible; by their design requirements, they are themselves susceptible to undermining and collapse.)

6.4.3 Open Foundations

Open foundations are constructed in such a manner to allow floodwaters to flow freely through them. Open foundations also minimize the total surface area that floodwaters may act upon. When compared to closed foundations for the same size building, an open foundation will have lower-magnitude flood forces acting on the foundation. Open foundations also offer the benefit of being less susceptible to damage from floodborne debris because they provide less contact area for debris to impact than closed foundations.

Simply stated, the portion of the foundation above exterior grade is minimal and allows nearly unrestricted movement of floodwaters beneath the building. Below-grade foundation components can be described as a deep foundation with deeply driven piers or caissons or shallow foundations with footings or grade beams. Terms such as deep and shallow are relative and are best used to refer to the maximum scour and erosion anticipated during a design event or during the projected life of the building.



Figure 6-8.
FORT MYERS BEACH, FLORIDA:
Oceanfront house constructed on an open foundation sustained only minor damage after being exposed to high winds and storm surge. (Source: FEMA 488)

NOTE

While Hurricane Charley created near design-level winds in Florida, the storm surge created by the hurricane was limited. As a result, it was not a design flood event in most impacted areas.

6.4.3.1 Deep, Open Foundations

Buildings founded and supported by driven piles or caissons in deep soil strata generally offer the greatest resistance to coastal hazards. When supported by foundations deep enough to retain sufficient strength to resist flood loads after scour and erosion have removed soils around the foundation, properly constructed buildings can fare well, even when exposed to wind loads. Post-event assessments have revealed success stories, even when buildings have been exposed to conditions greater than those anticipated during a design event. Figures 6-9 and 6-10 illustrate the successful use of deep, open foundations.



Figure 6-9.
FORT MYERS BEACH, FLORIDA:
Newly constructed house elevated on an open foundation sustained no storm surge damage when surges several feet deep impacted this site in 2004. (Source: FEMA 488)



Figure 6-10.
DAUPHIN ISLAND, ALABAMA:
Successful pile foundation following Hurricane Katrina. The foundation supported the elevated home even after scour and erosion removed several feet of soils.
(Source: FEMA 549)

Unfortunately, post-event assessments of buildings on deep foundations in coastal areas often reveal failures due to poor construction. Many of these failures result from the use of inadequately designed foundations or inadequate connections between the elevated structure and its foundation, as shown in Figures 6-11 and 6-12.



Figure 6-11.
DAUPHIN ISLAND, ALABAMA:
Structure near collapse due to insufficient pile embedment.
(Source: FEMA 549)



Figure 6-12.
LONG BEACH, MISSISSIPPI:
Structure removed from its foundation when waves exceeded the foundation height and connections between the elevated building and its foundation failed. The building was located within a mapped V Zone.
(Source: FEMA 549)

For successful performance, deep and open foundations must be designed to elevate the building above anticipated floodwaters, transfer all loads applied to the elevated building and the exposed foundation components to the supporting soils, and resist the damaging effects of breaking waves, moving floodwaters, and floodborne debris. FEMA 55 and ASCE 24-05 provide detailed design procedures to calculate the loads associated with these criteria. No prescriptive solutions for open foundations are provided in either the IBC or the IRC.

Pile foundations consist of deep vertical piles installed to support an elevated structure. Because pile foundations are typically set deep within the soil, they are inherently less susceptible to scour and erosion. Piles rely primarily on the friction forces that develop between the pile and the surrounding soils (to resist gravity and uplift forces) and on the compressive strength of the soils (to resist lateral movement and maintain the structure's lateral stability). The soils at the ends of the piles also help resist gravity loads. When the piles rest on their pile tips for load bearing, the designer must show that the soil surrounding the piles provides appropriate lateral stability. Serious consideration should be given by the designer to ensure that the structure is capable of maintaining its lateral stability during a storm event.

Several styles of deep, open foundations exist. Piles are typically treated wood timbers, steel pipes, or precast concrete members. Other materials, such as fiber-reinforced polyester (FRP), are available but are not commonly used in residential construction. For load path continuity, consideration should be given to extending the timber piles to the roof level (in single-story buildings) or to the second level (in multi-level buildings). This provides additional stiffness to the structure that reduces undesirable deflection in the building, increases the ability of a building to resist lateral loads, and may reduce the need to cross-brace the piles.

Crucial aspects of a pile foundation include pile size, installation method, embedment depth, bracing, and connections to the elevated structure (see FEMA, 499 Technical Fact Sheets No. 12, *Pile Installation*, and No. 13, *Wood-Pile-to-Beam Connections*). Inadequate embedment and the use of improperly-sized piles greatly increase the probability of structural collapse. Piles are appropriate for use within all coastal zones when the bearing and lateral capacities are verified by a geotechnical engineer.

The method of installation is a major consideration in the structural integrity of pile foundations. The ideal option is to use a driven-pile method, as it disturbs the supporting soil around the pile the least amount and results in the highest bearing capacity for each pile. Through this method, the pile is held in place with leads while a single-acting or double-acting diesel- or air-powered hammer drives the pile into the ground (see Figure 6-13).

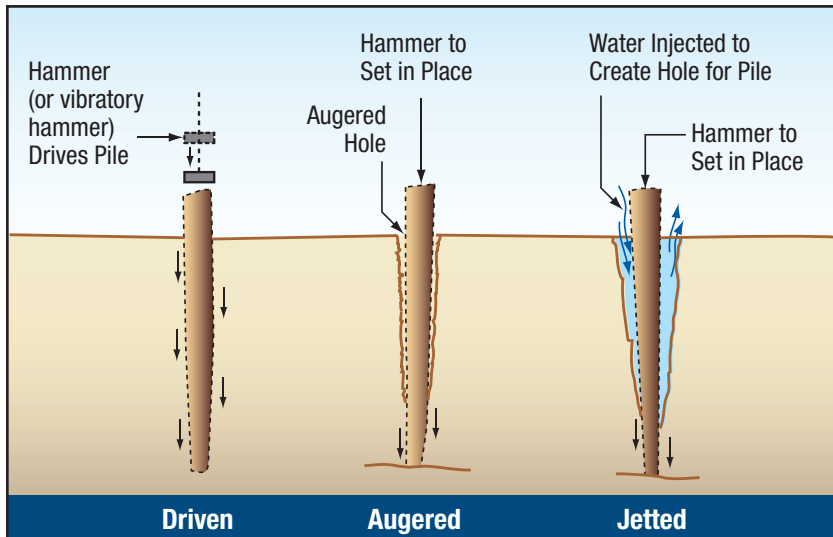

Figure 6-13.
Pile installation methods.
(Source: FEMA 55)

Driven piles may be set with vibratory hammers or with drop hammers, with drop hammers typically proving to be the less expensive choice. A drop hammer consists of a heavy weight raised by a cable (attached to a power-driven winch) which is then dropped onto the pile.

If steel piles are employed, only the driven-pile method should be used. For any pile driving, the authority having jurisdiction or the engineer-of-record may require that a driving log is maintained for each pile. The log will record the number of blows required per foot as driving progresses. This log is a key factor used to determine pile capacity.

Holes for piles may be excavated by an auger if cohesive soils with sufficient clay or silt content are present to prevent cave-in. Augering can be used alone or in conjunction with pile driving. If the hole is full-sized, the pile is dropped in and the void backfilled. Alternatively, an undersized hole can be drilled and a pile driven into it. When soil conditions are appropriate, the hole will stay open long enough to drop or drive in a pile.

Jetting is another frequently used method of inserting piles into sandy soil. Jetting involves forcing a high-pressure stream of water through a pipe that advances with the pile. The water creates a hole in the sand as the pile is driven until the required depth is reached. Unfortunately, jetting loosens the soil that will support the pile and the tip, resulting in a lower load capacity due to less frictional resistance. Figure 6-13 shows various methods of pile placement.

Wood-Pile-to-Beam Connections

Wood piles are used in many coastal areas for open foundation. These piles are often notched to provide a bearing surface for a beam supporting the house above. When this method is used, the notch should not reduce the pile cross section more than 50 percent (such information is typically provided by a designer on the building plans). A larger pile notch than 50 percent will result in a reduced capacity to carry lateral loads at the connection. Also, for proper support of vertical loads, the beam should bear on the surface of the pile notch.

Chapter 5 discussed the importance of connections within the continuous load path. Post-disaster investigations have observed that the wood-pile-to-beam connection point has been a critical link. If there is a poor connection at the point where the top of the pile connects to the building itself, failure may occur. An engineer should design the connection between a wood pile and the elevated structure (see FEMA 499, Technical Fact Sheet No. 13, *Wood-Pile-to-Beam Connections*). This connection may require pile bracing in order to reduce a pile's unbraced length and maintain a strong connection. Engineers should consider the pile group, the connections, and the floor system (diaphragm) as an entire system. In order to eliminate pile and connection failures, it is important that the floor system and the pile group act as a complete system and not independently.

Pile Bracing

While foundation designs that are free of bracing are preferred, most foundation designs using timber piles rely upon bracing. Possible exceptions include short-pile foundations (i.e., those extending between 4 and 6 feet above grade), foundations supporting small homes with limited vertical surfaces exposed to wind loads, or foundations in areas with low basic wind speeds. When installed properly, bracing increases the stiffness of the pile group that (in some cases) may allow for wider spacing of piles beneath the building or smaller diameter piles to be used. The inclusion of bracing increases the axial capacity of a timber pile due to the reduction in unbraced length. Bracing also reduces lateral displacements of the building by stiffening the foundation.

In wood-framed construction, bracing typically involves diagonal cross-bracing or knee-bracing. Diagonal cross-bracing consists of long, slender steel rods or dimensional lumber installed diagonally between adjacent piles. Knee braces are shorter members installed between piles and the beams they support. Knee braces extend from the upper portion of the pile to the beams and support the pile in such a manner that the unbraced length of the pile is effectively reduced while allowing the floor system to be elevated as high as possible. Due to the strength limitations inherent in wood framing, however, some of the proper connections required to transfer the loads are difficult to obtain with wood framing.

Diagonal cross-bracing is the most effective means of bracing a pile to reduce the unbraced pile length, but this method has vulnerabilities when used in coastal foundation applications. The braces themselves can obstruct moving floodwater and increase a foundation's exposure to impact from waves and debris (see Figure 6-14). Knee-bracing is less vulnerable to flood loads and debris impact but may not provide as much stability and support as diagonal cross-bracing.

Because diagonal braces tend to be slender, these members are susceptible to compression failures; hence, most bracing is considered tension-only bracing. Because wind loads and (to a lesser extent) flood loads

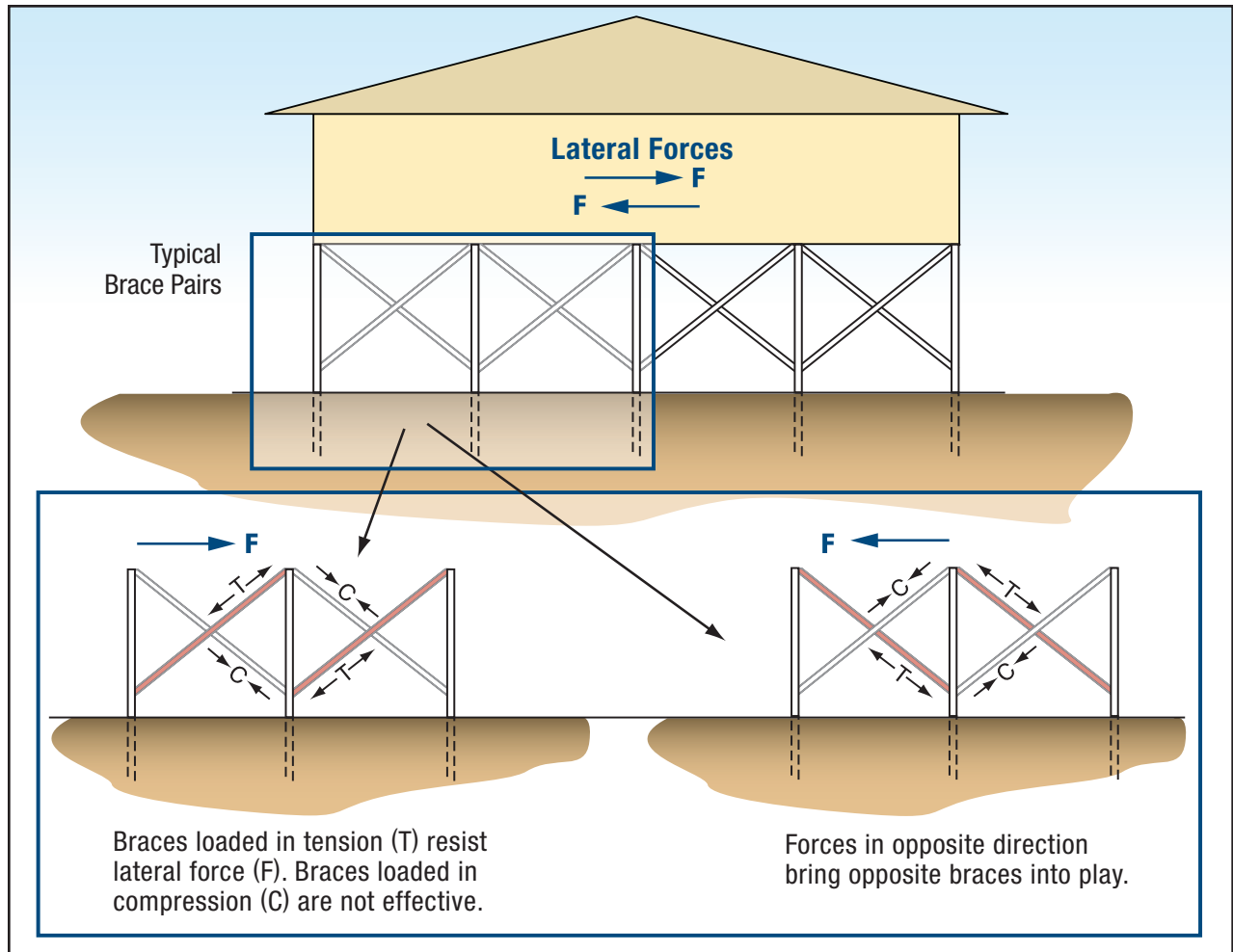

Figure 6-14.
Diagonal bracing schematic. (Source: FEMA 550)

can act in opposite directions, tension-only bracing must be installed in pairs. One set of braces resists loads from one direction while the second set resists loads from the opposite direction.

Figure 6-14 shows how tension-only bracing pairs resist lateral loads on a structure. The orientation of the bracing is an important design consideration and it is important that the bracing is constructed in a manner consistent with the plans. Bracing should be oriented parallel to the anticipated direction of the flow of water to reduce the potential for debris dams.

The placement of the bolted connection of the diagonal cross brace to the pile requires considerable judgment. If the connection is placed too high above grade, the pile length below the connection is not braced and the overall bracing will prove less strong and sturdy. If the connection is placed too close to grade, the bolt hole is more likely to be flooded or infested with termites. Because the bolt hole passes through the untreated part of the pile, flooding and subsequent decay or termite infestation may weaken the pile at a vulnerable location. The bolt hole should, therefore, be treated with a preservative after drilling and before bolt placement. Knots and other imperfections in the pile and bracing should also be considered when selecting the connection points. It is important to review Sections R319, R320, and

R402.1.2 of the IRC to make sure that once timber piles are notched and bolted, the piles are properly field-treated to resist decay and termite infestation.

The use of knee braces (see Figure 6-15) involves installing short diagonal braces between the upper portions of the pilings and the floor system of the elevated structure. The braces increase the stiffness of an elevated pile foundation and can be effective at reducing the lateral forces on a home. While knee braces do not stiffen a foundation as much as diagonal bracing, they do offer some advantages over diagonal braces. For example, knee braces present less obstruction to waves and debris, are shorter than diagonal braces, and are usually designed for both tension and compression loads. Unlike diagonal braces, knee braces do not reduce bending stresses within the piles (in fact, knee braces can actually increase bending stresses) and will not reduce the diameter of the piles required to resist lateral loads.

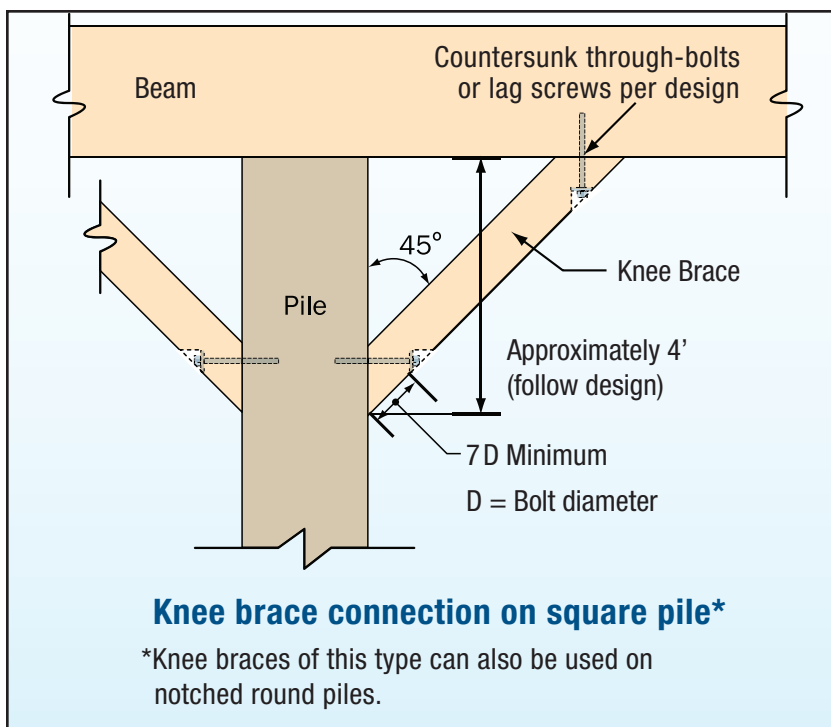

Figure 6-15.
Knee brace connection example.
(Source: FEMA 550)

The entire load path into and through the knee brace must be designed with sufficient capacity. The connections at each end of each knee brace must possess sufficient capacity to handle both tension and compression and to resist vertical loads in the brace. The brace itself must have a sufficient cross-sectional area to resist compression and tensile loads.

Grade Beams in Pile/Column Foundations

The term *grade beam* is used in a variety of ways to describe a number of foundation elements. The most common use in inland construction refers to a spread footing, which allows a foundation to uniformly distribute the load over areas of soil with reduced bearing capacity. However, in coastal areas, the term *grade beam* often refers to a construction technique utilizing a system of concrete pours that help to fix the locations of piles and thus mitigate some flood loads.

Pile foundations (see Figure 6-16) may be designed with grade beams (typically from wood or concrete). Grade beams provide many benefits:

- When incorporated with reinforced concrete or masonry column foundation systems (or with wood piles), grade beams provide lateral stiffness to prevent the need for diagonal cross-bracing or knee-bracing.
- Properly designed and constructed, grade beams facilitate load redistribution and can reduce the potential for collapse during extreme events.
- Grade beams can allow builders to accommodate the inevitable variations that always seem to affect pile placement.

To reduce the effect of scour and erosion on foundations, grade beams must be designed to be self-supporting foundation elements; that is, grade beams must not rely upon the soils beneath them for vertical support. Also, the piles must be designed to carry the weight of grade beams in order to address the condition that results when grade beams are undermined by scour or erosion, in addition to resisting all loads transferred to the piles from the elevated structure and the foundation. For this reason, it is important to ensure that other building elements are not connected to the piles. Slabs used below pile-elevated homes should not be connected to pile foundations or used as grade beams. If the slab is damaged

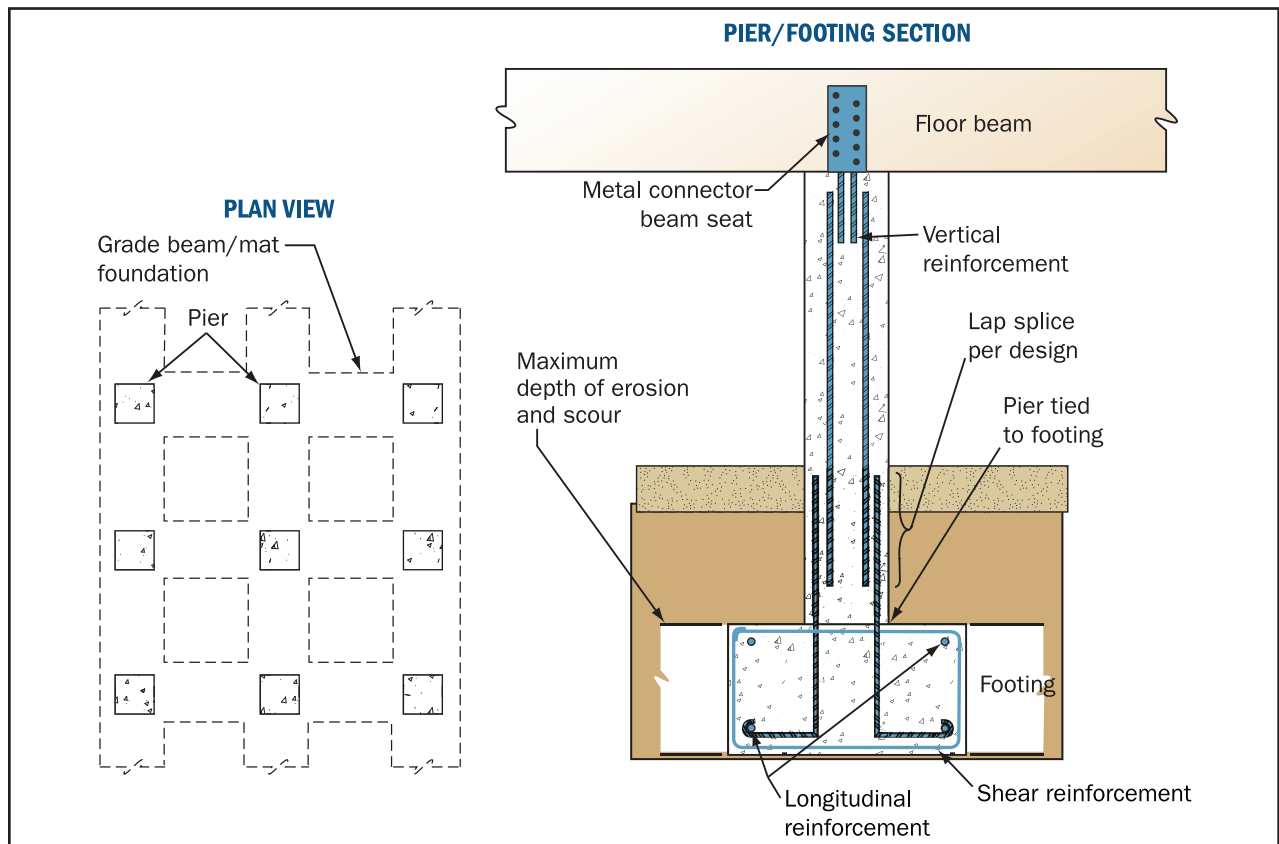

Figure 6-16.
Elevation view (right) of a concrete pile foundation using grade beams. (Source: FEMA 550)

or undermined, the slab may be exposed to flood forces and transfer loads to the foundation. In most cases, the foundation was not designed to resist these higher loads and the foundation may be overloaded, causing it to fail.

Consensus codes and standards generally do not contain prescriptive designs for open foundations; however, criteria are provided for performance-based design. Section 303.4 of SSTD-10 requires that wood-pile foundations, their beams, and connections between the beams and the piles must be designed by a registered engineer or architect. IRC Section R324.2 requires that foundations in V Zones be open (placed on columns or pilings). IRC Section R324.3.3 also requires that foundations in V Zones be designed to resist water loads associated with flooding and precludes the use of shallow (mat or raft) foundations in areas where erosion can undermine foundations. No code or industry standard currently provides prescriptive designs for open foundations. FEMA 550 provides guidance for engineers and architects who design foundations for coastal sites, as well as prescriptive designs for a wide range of buildings and foundation styles.

Breakaway Walls

Within the SFHA, walls may be used to enclose the area below the lowest floor, but these create a condition which must be addressed. The walls or enclosure may consist of latticework, insect screening, or walls specifically designed to fail or break away under water or wind loads without causing structural damage to the rest of the structure. It is important that these walls be constructed with flood-resistant materials. They are designed to break free with loads of not less than 10 pounds per square foot but not more than 20 pounds per square foot to prevent their loading from imparting additional lateral loads on structural members. These walls are typically constructed of wood studs with an exterior sheathing, but they may be constructed of unreinforced masonry units and designed to fail at the mortar joints.

A key feature of a successful breakaway wall is that the exterior sheathing does not overlap the structure's piling or vertical members. Additionally, it may not overlap the lowest horizontal structural member or above that. These design features ensure that the wall failure does not impact the main structure. Breakaway walls should be certified by a professional engineer or architect and the proper documentation submitted with the building permit. (See FEMA NFIP Technical Bulletin 9: *Design and Construction Guidance for Breakaway Walls Below Elevated Coastal Buildings* (FIA-TB-9), for further information.) See Figure 6-17 for an example of the successful use of a breakaway wall and Figure 6-18, which demonstrates building damages due to incorrect construction of a breakaway wall.

6.4.3.2 Shallow, Open Foundations

Shallow, open foundations generally consist of concrete or masonry piers placed on concrete footers. Their open style makes their use desirable in areas where breaking waves may exist. Because they are founded on shallow soils, however, they remain vulnerable to scour and erosion.

Shallow, open foundations may be allowed, but their use may not be suitable for V Zones (see Figure 6-19). If a shallow, open foundation can be undermined by scour or erosion, the foundation would not satisfy the NFIP requirement of preventing collapse. These foundations are more suitable for use within Coastal A Zones, where the presence of erosion and scour is limited. Shallow, open foundations may be used within Coastal A Zones if the tops of their footings can be placed below the maximum scour and



Figure 6-17.
Successful use of
a breakaway wall.
(Source: FEMA 489)



Figure 6-18.
Building damages due to
the incorrect construction
of a breakaway wall.
(Source: FEMA 489)

erosion levels anticipated for the life of the structure. The tops of the footings should be positioned below the maximum anticipated scour or erosion depth because any uncovered area of a footing will be exposed to flood forces. Also, any uncovered area of a footing acts as an obstruction to moving floodwaters and will contribute to localized scour. In all applications (whether inland or coastal), frost-depth requirements must be considered, as they may dictate the depth at which the top of these footings is set. Where expected erosion and scour cannot be accurately quantified, deep and open foundations (such as pilings) should be used.

The performance of shallow, open foundations depends largely upon the style of footing used to support concrete or masonry piers. Discrete pad-style footings rely only upon the weight of the elevated structure and the soil-bearing capacity to resist overturning. When exposed to lateral loads or when undermined by erosion or scour, discrete footings can rotate. Therefore, piers placed on discrete footings are considered to reflect best practices only when wind and flood loads are relatively low. Post-disaster investigations have revealed that a discrete footing may fail when a building is exposed to lateral loads, even when it is not undermined by scour and erosion (see Figures 6-20 and 6-21).

A desired alternative to discrete pad footings is to construct a matrix of grade beams. Piers placed on continuous concrete-grade beams or concrete strip footings provide much greater resistance to lateral loads because the grade beams/footings act as an integral unit and are less prone to rotation.

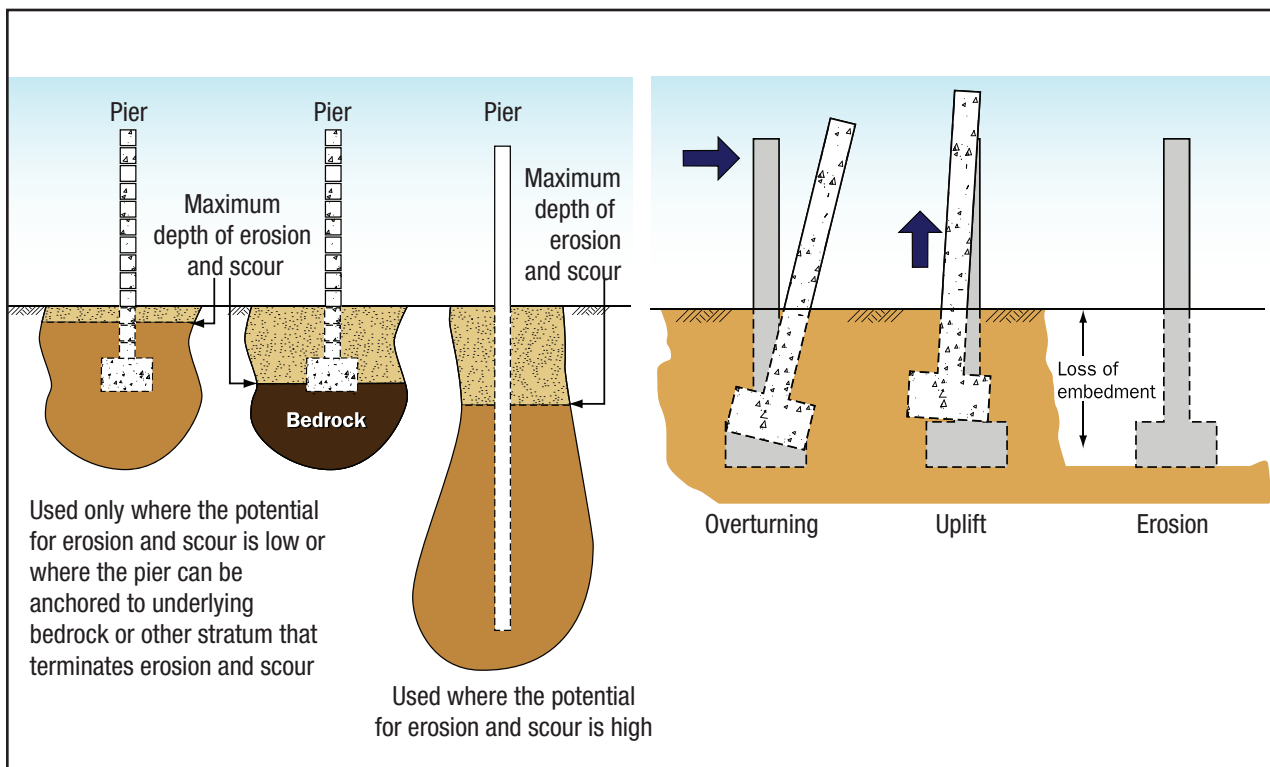

Figure 6-19. Possible failure modes for masonry piers. (Source: FEMA 550)



Figure 6-20.
PASS CHRISTIAN, MISSISSIPPI:
Performance comparison of shallow, open foundations founded on discrete footings (foreground) failed by rotating and overturning, while piers located on more substantial footings—in this case, a concrete mat (background)—survived. (Source: FEMA 549)

Footings and grade beams must be reinforced to resist the bending moments that develop at the base of the piers due to the lateral loads on the foundation and the elevated home (see Figure 6-20). Lateral flood and wind forces result in detailing and connection/reinforcement requirements that are more significant and robust than those commonly used for inland construction. The use of minimal reinforcement or small connectors should be questioned as to their adequacy in coastal applications/foundations (see Figure 6-21).

Although the IRC provides prescriptive solutions that may be used for designing the building above the foundation, the IRC does not provide prescriptive designs for open foundations. FEMA 550 contains guidance for engineers and architects who design foundations for coastal sites. FEMA 550 also offers prescriptive designs for a wide range of buildings and foundation styles. Addendum C of ICC-600 (released in September 2008) includes some prescriptive designs for open foundation. The addendum has prescribed beam designs that can be used in conjunction with FEMA 550 foundation designs.



Figure 6-21.
**BELLE FONTAINE POINT,
JACKSON COUNTY, MISSISSIPPI:**
Column connection failure.
(Source: FEMA 549)

6.5 Soils Investigation

The foundation design chosen should be based upon the soils that exist at the building site. The IBC and IRC require soil-bearing capacities that are identified in IRC Section R401.4 and IBC Section 1802, respectively. Soil parameters can be determined from the following:

- Soil samples from borings or test pits on the site
- A review of borings from nearby sites
- Information from the local office of the Natural Resources Conservation Service (formerly known as the Soil Conservation Service) and soil surveys published for each county
- The types of foundations that have been installed within the area in the past
- The proposed site history, which would indicate the presence of buried materials (This may require a search of land records showing past ownership focused on how the site may have been used in the past.)

One of the parameters derived from a soil investigation is the bearing capacity, which measures the ability of soils to support gravity loads without soil shear failure or excessive settlement. Commonly measured in pounds per square foot (psf), soil-bearing capacity typically ranges from 1,000 psf for relatively weak soils to more than 10,000 psf for bedrock.

Frequently, designs are initially prepared according to a presumed bearing capacity. It is then the homeowner's responsibility to verify actual site conditions. The actual soil-bearing capacity should be determined. If soils are found to have higher bearing capacity, the foundation can be constructed as designed or it can be revised to take advantage of these better soils.

The allowable load-bearing values of soils specified in IBC Section 1804 can be used when other data are not available. However, soils can vary significantly in bearing capacity from site to site. A geotechnical engineer should be consulted when unusual or unknown soil conditions are encountered.

The lateral capacity of the soil should not be overlooked. Building failure due to a lack of lateral soil capacity is common during storm events. In addition to verifying the bearing capacity of the soil at the site, the soil's lateral capacity should be consistent with the presumed lateral capacity in the building plans. In the event that the soil lateral capacity does not meet the design capacity of the foundation, the building foundation will need to be modified in order to account for site conditions.

Building Framing Systems and Best Practices

7.1 Introduction

The importance of properly designed foundations was discussed in Chapter 6, *Coastal Foundations and Best Practices*. In this chapter, the importance of building framing systems is discussed.

A building's framing works in conjunction with its foundation to provide strength and stability for the structure; it is also another critical component of the load path. Properly designed and constructed building framing is important in all locations; however, in coastal areas (where wind, flood, and other loads can be extreme), ensuring proper building framing is critical.

Framing must transfer all gravity, uplift, and lateral loads to the foundation. In buildings (including residential structures), framing systems typically consist of the roof structure that supports the roof deck, exterior and interior load-bearing walls, beams, girders, posts, and floor framing. Shear walls (or steel moment frames in homes with large windows or other large openings) provide the strength to resist lateral loads.

The integrity of the overall building depends not only upon the strength of these components, but also on the adequacy of the connections that exist between them. Critical connections occur throughout the structure but, in most houses, the most critical connections exist where the roof system connects to supporting walls; at openings and headers in the walls; where walls connect to each other at floor levels; and where walls connect to the foundation. Refer to Chapter 5 for a detailed discussion on the continuous load path concept and the importance of connections within the load path.

While the term framing typically refers to either wood or light-gauge steel framing, walls constructed with concrete or masonry systems are also typically used to carry loads and to act as the frame of the building. Load-bearing wall systems of any construction type can and should be considered as part of building framing discussions. As such, load-bearing wall systems are presented in this chapter.

While buildings are constructed from the ground up, Chapter 5 identified how they are often analyzed from the roof down in order to track the presence of a continuous load path. Likewise, this discussion on building framing begins with the roof-framing structure. However, before concentrating on roof framing, a brief discussion of diaphragms and shear walls is presented because they are two of the key elements in the framing of load-bearing wall systems in most residential and light commercial construction.

7.2 Diaphragms and Shear Walls

Most residential and light commercial construction is based on box design. In box design, horizontal diaphragms (e.g., roof and floor systems) work in conjunction with vertical shear walls to support gravity loads, resist lateral loads, and provide structural stability. In wood and light-gauge steel-framed construction, the diaphragms and shear walls (called braced wall lines or braced wall panels in many codes and standards) are constructed similarly. Both use framing members (such as dimensional lumber, engineered lumber, or light-gauge C-shaped steel members) surfaced with structural sheathing (typically plywood or OSB). The IRC and IBC provide prescriptive, framed, shear wall designs that may be incorporated into the building design to resist lateral loads. The prescriptive designs specify requirements for wall bracing, braced wall lines, and braced wall panels.

DEFINITIONS

Shear Wall – Walls used in building construction that aid in transferring lateral loads from the roof system or walls down to the foundation.

Diaphragms – Either roof or floor systems that transfer lateral loads to the shear walls or to the foundation.

Nearly all homes have exterior shear walls. Relatively long homes, large homes, or homes with large openings in the exterior walls may have interior shear walls, as well. Engineered homes with large window or door openings may use moment frames to resist lateral loads in addition to shear walls. While constructed similarly, diaphragms and shear walls act in different ways as they both work to transfer loads down to the foundation of the structure.

The edges (or ends) of diaphragms and shear walls are critical. When diaphragms and shear walls are connected, it is critical that this connection allows loads to be passed in order to ensure that these components will function together as a system. Figure 7-1 illustrates how the shear wall transfers the

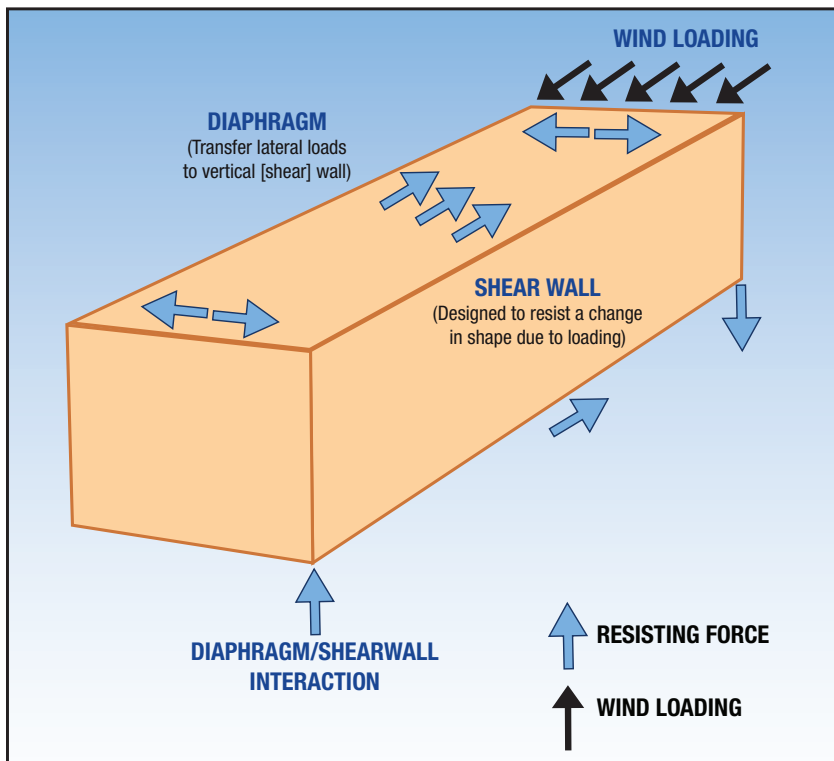

Figure 7-1. Load transfer between diaphragms and shear walls.

loads applied to the roof through the walls and down into the foundation of the house. This chapter provides valuable information that explains what is involved in creating a proper connection in the wall and framing systems of coastal buildings.

When wind forces act on a building, transferring these induced loads through the house will require connections to transfer the loads into the shear wall through both compression (pushing) and tension (pulling). It is important that all of the elements of the building work together in order to create the maximum amount of structural strength and allow the building to maintain its shape and not compromise the building envelope. A failure in the connection or any of the members could result in structural failure. Post-disaster investigations have repeatedly observed roof collapses and wall failures that are representative of the inability to provide a proper connection at this location in the load path. Figures 7-2 and 7-3 show the detailing required in order for the diaphragms and shear walls to maintain their rigidity and shape so that proper connections are maintained.

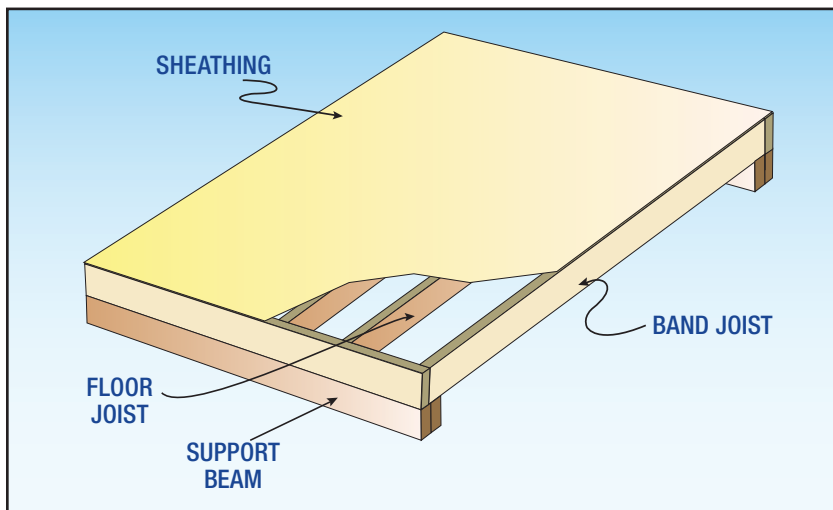

Figure 7-2.
Horizontal diaphragm and diaphragm components.

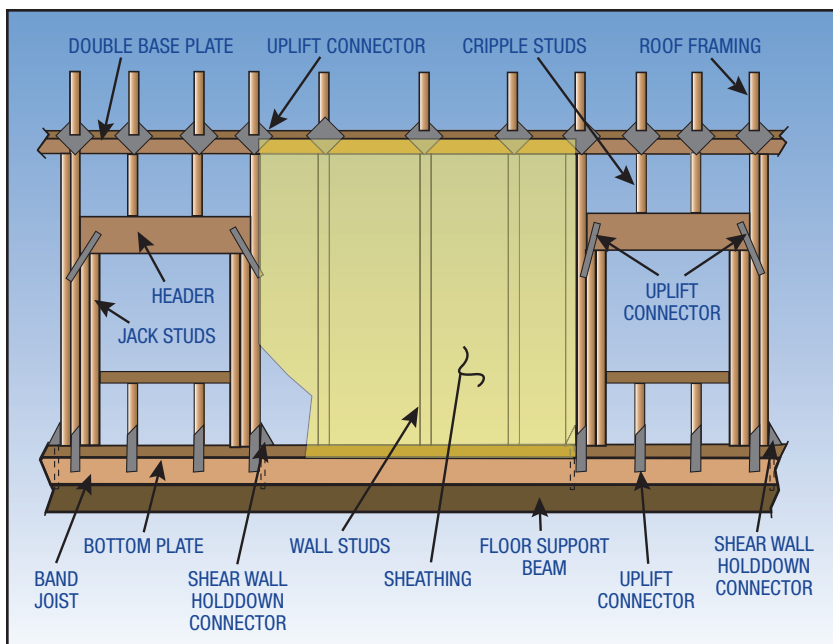

Figure 7-3.
Vertical shear walls and shear wall components.

Many of the requirements in prescriptive codes and standards are intended to ensure that buildings are constructed with adequate floor and roof diaphragms and shear walls. Specifically, the IBC, IRC, WFCM, and ICC-600 provide prescriptive shear wall details and designs that may be applied when certain basic conditions are met. Table 2304.6 of the 2006 IBC lists the minimum thickness of wall sheathing and maximum wall-stud spacing for various types of wooden shear-wall applications; Table R602.3(1) of the IRC prescribes a fastener schedule for wooden structural members used in wall construction. Similar prescriptive measures exist in other codes and standards and vary with material type.

7.3 Roof Construction

Post-disaster evaluations of coastal buildings damaged during high-wind events have consistently shown that structural failures often begin with the roof. Winds can remove roof coverings from the roof sheathing, tear roof sheathing from supporting framing (see Figure 7-4), and rip roof framing from supporting walls. The loss of roof coverings and roof decking can allow water to enter a building and damage or destroy interior finishes and contents, or even worse, may destabilize a structure and lead to building collapse.



Figure 7-4.
Loss of roof sheathing due to inadequate fastening between roof sheathing and framing.
(Source: FEMA 549)

The structural integrity and successful performance of the roof structure during high-wind events depends upon: 1) adequately designed and spaced roof-framing members, 2) adequate lateral bracing to support roof framing, and 3) adequate connections between the roof structure and the top of the wall to create a complete vertical load path. The roof structure (consisting of the roof framing, roof decking/sheathing, and any internal bracing) also functions as a horizontal diaphragm and transfers the horizontal loads imposed on the roof to the supporting walls below.

Roof failures are often observed on areas of the building where wind pressures are concentrated. These areas include the high-pressure eave and corner zones, porch and roof overhangs, gable ends, and where roof framing joins bearing walls or beams. The connection of the sheathing to the supporting members in these areas is most critical and often may be detailed with a higher density of connectors than other roof areas.

7.3.1 Roof Sheathing

Roof sheathing is the first structural component in the load path between the roof system and the foundation. The first envelope components (i.e., the roof covering and roof underlayment) are typically non-structural and are discussed in detail in Chapter 8, *Roof Covering and Best Practices*.

The roof sheathing supports gravity loads, such as the roof live load, snow load, and vertical-uplift loads created by wind pressures. Also, the roof sheathing (working in conjunction with the roof framing) must function as a diaphragm to transfer lateral loads to the building's shear walls.

The IBC, IRC, WFCM, and ICC-600 all contain prescriptive requirements for fastening roof sheathing. The fastening requirements are those required to resist uplift forces from wind pressures and shear forces from lateral loads.

Most codes and standards allow the use of common nails to connect sheathing to supporting members for sites where basic wind speeds are less than 100 mph (110 mph in non-hurricane-prone regions) but require ring-shank nails in higher-wind zones. Ring-shank nails have higher withdrawal capacities (expressed in ratings) and are needed because they provide resistance to the high forces acting on the sheathing panels from the roof pressures in higher-wind zones. Another option is to use wood screws in place of nails because they tend to have higher withdrawal capacities. Best practices recommend the use of wood screws particularly in the eaves and corner zones of the roof, where winds can create large uplift (suction) pressures. Unless directed otherwise by design professionals, wood screws should have (at a minimum) the same diameter as the nails prescribed by the codes or standards and should be located according to the same spacing interval (or be even more closely spaced). It is also important to note that the density of the roof framing member must be taken into account when determining fastener spacing. Relatively dense framing (such as is achieved with Southern Yellow Pine members) holds fasteners better than lower-density framing (such as Spruce Pine Fir members) and may allow for wider spacing of fasteners.

The fasteners securing roof sheathing must penetrate into the supporting roof framing to prove effective.

Shiners (i.e., nails that miss roof framing when hammered into place and whose metal surfaces shine when viewed from the attic space below) provide no strength and no withdrawal capacity and constitute a discontinuity within the load path (see Figures 7-5 and 7-6). Also, fasteners should not be overdriven. Overdriving the fasteners increases the potential for the roof sheathing to tear around the heads of the fasteners as the nail head penetrates into the wood sheathing. The overdriving of nails frequently occurs when pneumatic or gas-powered nailers are used without proper settings. This issue can be addressed onsite by a contractor by properly calibrating the tools being used.



Figures 7-5 and 7-6.
Exterior and interior views of connection issues
between the roof sheathing and the top chords
of the roof truss system. (Source: FEMA 55)



Wood structural panels are rated according to their ability to span between structural members. The prescriptive portions of the IBC and IRC list the minimum thickness of sheathing depending upon the spacing of the roof framing. For example, Table 2304.7(1) of the IBC gives minimum net thicknesses of lumber that may be used in floor and roof sheathing. Table R803.1 of the 2006 IRC prescribes minimum net thicknesses of sheathing depending on rafter-beam spacing for lumber roof sheathing. Section 307.4 of SST-10 specifies minimum 15/32-inch roof sheathing unless other thicknesses are required for adequate roof diaphragm strength. Table 3.12A of the WFCM specifies sheathing based upon the design-wind speed and the spacing of the roof framing for the Exposure B category of wind exposure. WFCM Table A3.12A relates to more stringent Exposure C conditions. Higher basic wind speeds and wider roof-framing spacing requires thicker roof sheathing. WFCM Table 3.12B specifies roof sheathing requirements for snow loads. In areas exposed to both snow and wind loading, the most stringent requirement applies.

A final comment on roof sheathing: It is important to note that the unsupported edges of roof sheathing can flex excessively under load. The American Plywood Association suggests that support be provided for panel edges exposed to walking loads (such as floors and lower-sloped roofs). The use of solid blocking is considered best practice as a means of support, but H-clips can be used for additional edge support. When utilizing H-clips, it is important to consult the manufacturer's spacing requirements to ensure that adequate structural support is attained with the clips.

7.3.2 Roof Framing

Roof framing is the next building component found within the load path. The roof framing must support the roof decking and sheathing and resist loads applied to the sheathing and transfer loads vertically to support walls (or frames). The roof framing must also function as part of the roof diaphragm to transfer lateral loads to the shear walls below.

Roof framing typically consists of dimensional lumber rafters or engineered roof trusses. For rafters, design professionals can calculate rafter sizes or sizes can be determined by prescriptive span tables, such as those contained in the AF&PA's *Span Table for Joists and Rafters* or Table 12 of the WFCM. The IBC and IRC also contain span tables. Rafters must be sized to resist dead loads (i.e., the weight of the roof system including rafters, sheathing, roofing, and underlayment, plus any permanent attachments), roof live load, snow load, and wind load. Roof framing must also be sized to control deflections. In areas where the snow load is less than 20 psf, wind loads often dictate the sizing of rafters. In all areas, the most stringent loading must be determined and the rafters sized appropriately.

Connections to resist uplift and adequately transfer lateral loads can be determined by a design professional or from prescriptive standards. Table 3.4 of the WFCM lists the required capacity of the connections between the roof framing and walls (framing or other). Prescriptive designs for toe-nailed connections are provided in Table 3.4A; connections using 20-gauge galvanized straps are listed in Table 3.4B. Tables 3.4, 3.4A, and 3.4B cover Exposure B conditions. Exposure C conditions are detailed in Tables A3.4, A3.4A, and A3.4B. An example of a masonry wall-to-roof truss uplift connection is shown in Figure 7-7.

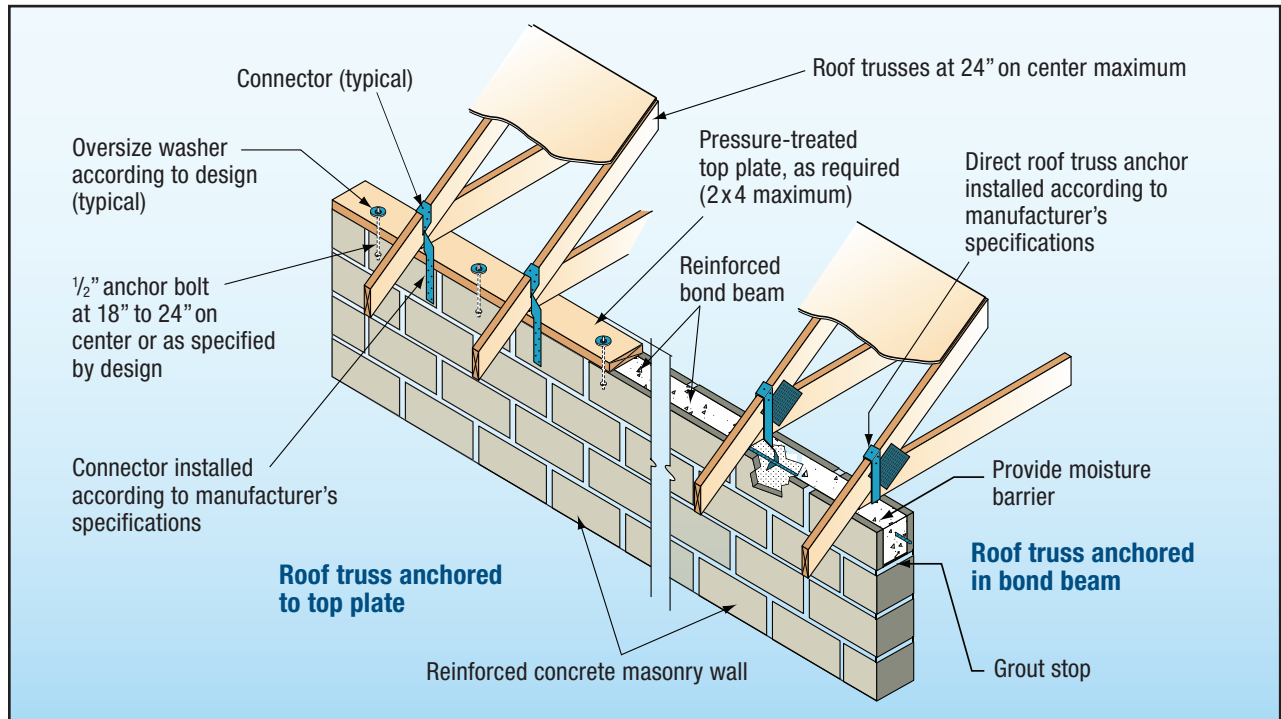

Figure 7-7.
Detail of masonry wall-to-roof trusses. (Source: FEMA 499)

For trussed roofs, the truss manufacturer typically also serves as the truss designer. Therefore, the truss manufacturer is charged not only with providing specific details relating to truss construction (e.g., the size of members and truss plates) but also with indicating the need for field-installed truss bracing that may be required to prevent buckling of compression members. All truss bracing must be properly installed as directed in the plans, in order for the trusses to function as intended. The truss designer generally specifies bearing and uplift reactions, but does not specify which connectors should be used to secure the trusses. Building officials and plan reviewers should pay careful attention to ensure that all appropriate information (such as the basic wind speed) has been provided on truss drawings by the manufacturers and to identify what additional information must be provided by the builder. A copy of the truss drawings should be required as part of the permit submittal. Providing connectors that may be needed to resist uplift and provide a continuous load path at this location within the load path is not the responsibility of truss manufacturers; the use of these connectors must be determined and specified by others. The use of connectors may be recommended either by design professionals or by prescriptive standards, such as the WFCM.

Information on roof-frame inspection points can be found in FEMA 55, Table 13.6: *Roof Inspection Points*. The table and the associated discussion provides the local official with common roof construction items that should be noted, as well as a summary of topics described in detail within this section.

7.4 Wall Construction

Exterior walls are the next building component found within the framing's load path from the roof to the foundation. Like the roof, exterior walls must resist loads imposed on them (particularly by wind or seismic activity) and typically must function as assemblies to provide stability for the entire structure.

Three types of loads can be imposed on exterior walls. First, out-of-plane loads (i.e., loads that exist out of the plane of, or perpendicular to, the wall) are imposed on the walls. These loads result primarily from wind but can also result from seismic activity. All exterior walls are exposed to these out-of-plane forces.

Secondly, vertical loads (also called axial loads) are transferred into some walls from the roof (or upper-story walls) above. The vertical loads can be downward-acting gravity loads that result from the weight of the structure or upward-acting (uplift) loads from wind or seismic events. Uplift and gravity loads are considered in-plane loads since they occur within the plane of the wall, but act along the vertical axis of the wall. All load-bearing walls are exposed to in-plane gravity loads (such as the dead loads of non-load-bearing walls). In addition to the in-plane gravity loads, many walls are also exposed to uplift loads.

Lastly, in-plane horizontal loads can also exist in some walls. These loads typically result from wind forces imposed on building surfaces that are perpendicular to the walls. For example, wind loads acting on a building's roof and front wall create horizontal loads in its left and right walls. Those horizontal loads are collected through horizontal diaphragms such as floors and roof decks, and are called shear loads. The walls that are needed to resist these loads are called shear walls or shear panels. Shear loads are in-plane loads since they occur within the plane of the wall. Shear walls may also be needed to resist out-of-plane loads from wind or seismic events. In addition, shear walls may function as load-bearing walls. Shear walls that function as load-bearing walls are exposed to all three types of loading (see Figure 7-8).

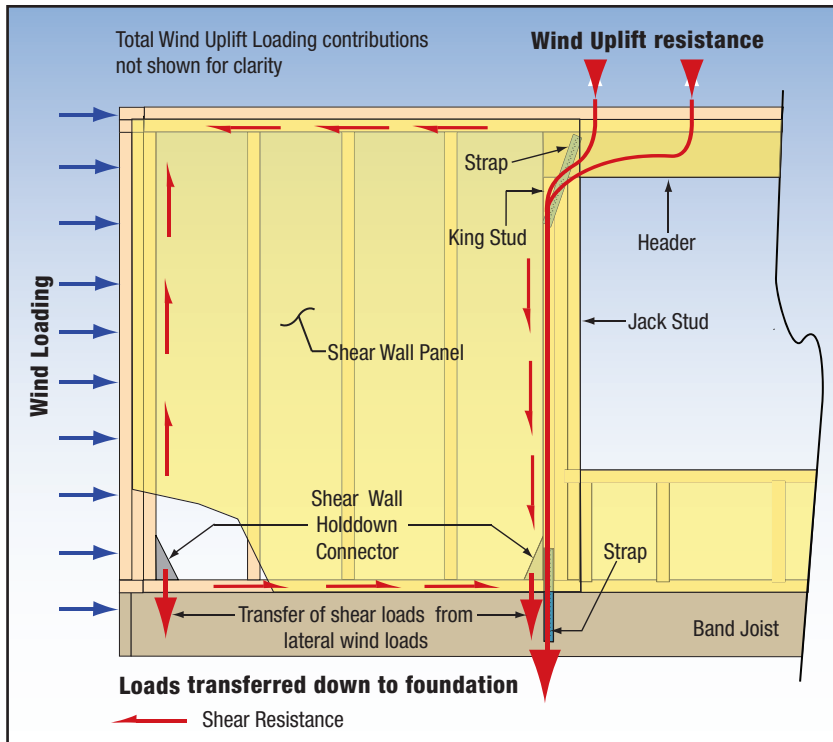

Figure 7-8.
Horizontal loadings exerted on exterior walls.

NOTE

Although exterior walls are typically framed with 2 by 4 lumber, the use of 2 by 6 lumber should be considered. Using 2 by 6 lumber increases the strength of the exterior walls and offers a larger cavity for insulation, thus increasing the energy efficiency of the building.

7.4.1 Wall Sheathing

As mentioned in the previous section, all exterior walls must resist out-of-plane forces. Section 602 of the IRC specifies minimum wall-sheathing thickness and fastening requirements for structural panels, plus a variety of other sheathing styles (such as cellulosic fiberboard and gypsum sheathing). Table 3.11 of the WFCM specifies minimum wall-sheathing thickness for structural sheathing based on stud spacing for Exposure B conditions. Exposure C conditions are specified in WFCM Table A3.11.

While cellulosic and gypsum sheathing is accepted by the IRC as wall sheathing, FEMA and others recommend installing wood structural panel sheathing for all exterior walls as a best practice. It was observed during post-event evaluations that wood structural panels perform better and are more resistant to windborne debris than other sheathing materials that are allowed by building codes for the provision of shear resistance.

7.4.2 Shear Walls

Shear walls provide lateral stability for a structure. Section R602.10 of the IRC provides prescriptive construction details and requirements for braced wall lines and braced wall panels for buildings exposed to 3-second gust basic wind speeds less than 110 mph (less than 100 mph in hurricane-prone areas). The WFCM provides prescriptive shear wall details for 3-second gust wind speeds from 85 mph to 150 mph. In addition, Section 305.4 of SSTD-10 provides shear wall designs appropriate for use in buildings exposed to wind speeds up to 110 mph (fastest mile).

Shear walls may also be constructed with masonry, concrete, ICF (Insulated Concrete Forms) and with structural insulated panels (typically referred to as SIP). SIPs consist of wood structural panels which sandwich a rigid insulation core, which is typically polystyrene (although urethane is also used).

When analyzing shear walls, two classifications of shear walls exist. Segmented shear walls are full-height, fully sheathed wall segments that function independently to resist lateral loads (see Figure 7-9).

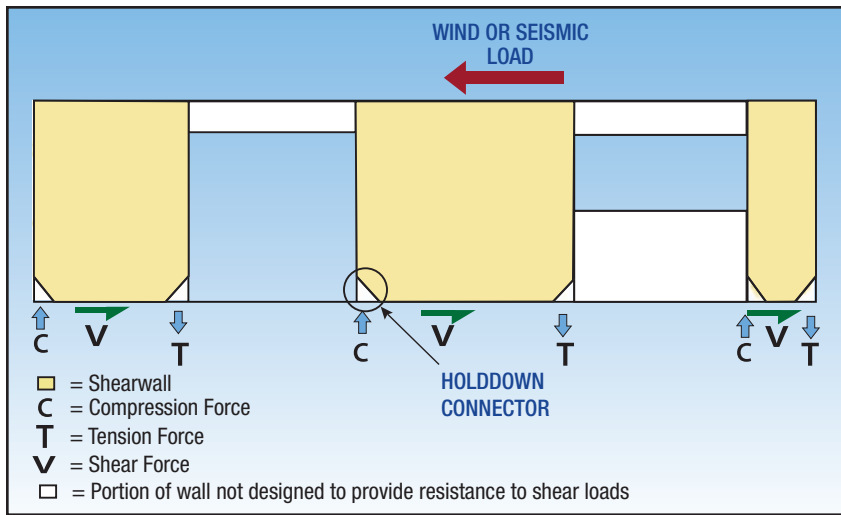

Figure 7-9. Segmented shear walls.

Perforated shear walls contain framed openings for windows and doors. Perforated shear walls rely upon continuous structural elements over windows and door openings to make the shear wall function as a single unit (see Figure 7-10). These elements are called drag struts.

For wind design, the WFCM lists the total lengths of segmented shear walls required in a home in Exposure B areas for winds perpendicular to the roof ridge (Table 3-17A) and parallel to the roof ridge (Table 3-17B). Exposure C requirements are listed in Tables A3-17A and A3-17B. Seismic requirements are listed in Table 3-17C.

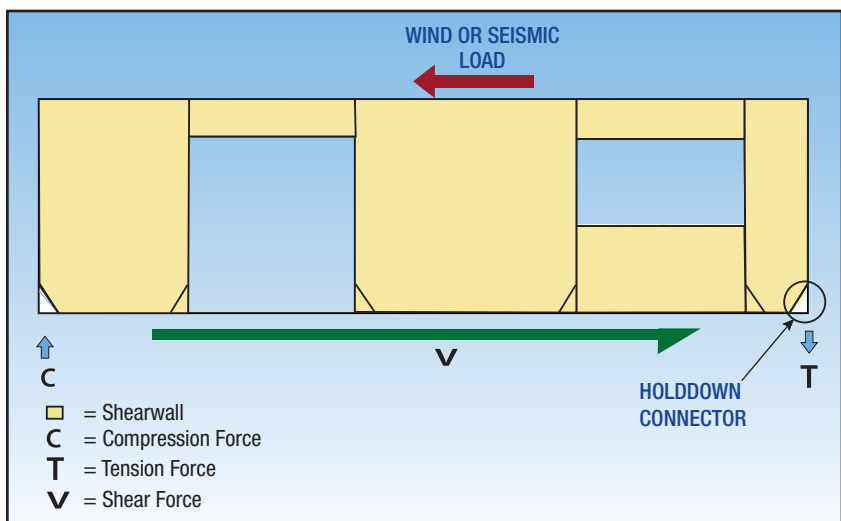

Figure 7-10. Perforated shear walls.

NOTE
Special care should be used when utilizing or checking a design based upon the WFCM tables (or any prescriptive tables) to ensure that all appropriate adjustment factors are being correctly applied.

Per WFCM Section 3.4.4.2, the shear wall lengths tabulated are based upon a standard shear wall. The standard wall is a blocked¹ shear wall constructed with 7/16-inch wooden structural panels attached with 8d nails 6 inches on centers (at panel edges) and 12 inches on centers (within the interior of the panel, also called the field). The inside surface of the standard wall or shear wall panel (i.e., the surface that is exposed to the finished/living space) is surfaced with 1/2-inch gypsum drywall secured with 5d cooler nails at 7 inches on centers along edges and 10 inches on centers within the panel. These standard shear walls provide a shear capacity of 436 pounds per linear foot. Adjustment factors for variations on standard shear wall construction are provided in Table 3.17D. Shear walls with lower shear capacity require longer wall lengths; walls with higher shear capacity require shorter wall lengths.

The WFCM contains criteria needed for constructing perforated shear walls. The criteria are determined by multiplying the tabulated shear wall lengths (in feet) listed for segmented shear walls in Table 3.17A, 3.17B, or 3.17C by adjustment factors listed in Table 3-17E for perforated shear walls. The adjustment factors in Table 3.17E are based upon the size and aspect ratios (height/width ratios) of the framed openings within the perforated shear walls. Tables 3.17A and 3.17B list the minimum segmented shear wall lengths required to resist wind loads. (Table 3.17A is for shear walls parallel to the wind and Table 3.17B is for shear walls perpendicular to the wind.) While Tables 3.17A and 3.17B address shear wall requirements to resist design wind events, Table 3.17C lists shear wall requirements for seismic events. Like Tables 3.17A and 3.17B, Table 3.17C provides the required length of segmented shear walls (in feet). Unlike Tables 3.17A and 3.17B (which list the minimum lengths of shear wall segments), Table 3.17C contains formulas necessary to determine those lengths.

For example, if Table 3.17A requires a minimum of 15 feet of shear wall segments be provided to resist winds perpendicular to the ridge and Table 3.17E lists a perforated shear wall adjustment factor of 1.33 based upon the size and aspect ratios of openings within that wall, then 20 feet (15 feet x 1.33) of perforated shear wall must be provided.

Generally, greater lengths of perforated shear walls are needed to resist lateral loads than segmented shear walls. Also, in perforated shear walls, more attention in the detailing and design is needed above doors and windows, where framing functions as drag struts. The greater attention is needed to ensure that the drag struts and their connections are adequate to transfer in-plane loads through the shear wall. The benefit of perforated shear walls is that they only need to be anchored at their ends while the ends of each segment of a segmented shear wall need to be anchored. This is discussed in the following section.

7.4.2.1 Shear Wall Anchorage

Shear walls (whether segmented or perforated) must be anchored to the foundation² (or the shear wall below when on an elevated floor) to complete the continuous load path within this area of the building. A proper anchorage or connection prevents the shear walls and, in turn, the rest of the structure from laterally racking, displacing, or overturning during a high-wind or seismic event.

¹ Blocking is short framing members installed between wall studs or floor joists. Blocking provides a method to fasten the unsupported edges of sheathing panels.

² Small, relatively heavy homes (or homes placed in low-wind areas) may have sufficient weight to avoid requiring shear-wall anchorage. Even in such instances, shear-wall anchorage is advised for structural redundancy.

Segmented shear walls need to be anchored at the edges or ends of each shear wall panel. Perforated shear walls typically only need anchorage at their ends. Figure 7-11 illustrates a typical large anchor that may be connected at the end post of a framed shear wall.

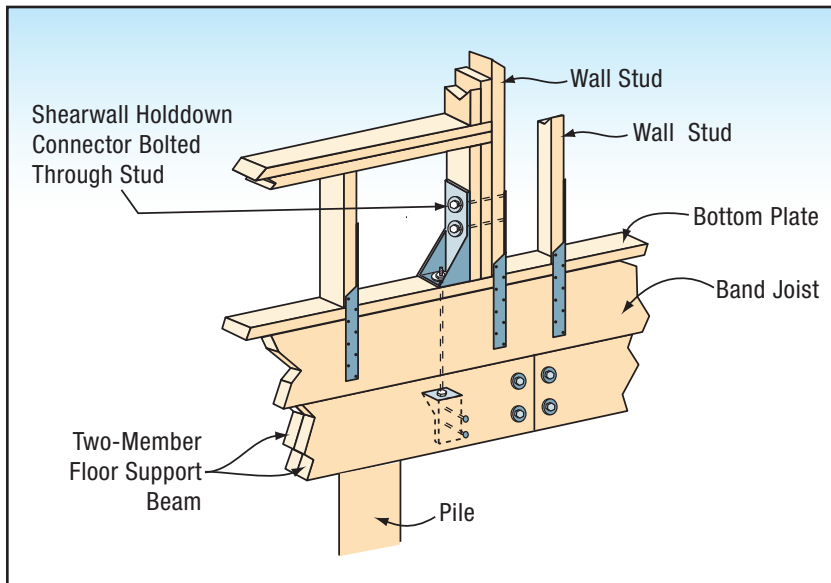

Figure 7-11.
Shear wall anchor. (Source: FEMA 55)

Shear wall anchorage capacities for multi-level buildings are additive. In other words, anchorage for upper-level shear walls needs to be provided in addition to first-floor anchorage. Where segmented shear wall panels line up vertically, the panels can share anchorage devices provided the anchorage device is capable of resisting the total load for all shear panels that it anchors. The same is true for the ends of perforated shear walls. Multi-level perforated shear walls can share anchorage at their ends, provided the anchor is capable of resisting shear wall reactions for all levels.

The reactions (loads) at the ends of shear walls are proportional to wall height. Taller walls develop larger reactions and require stronger anchors, and anchorage requirements for even small homes can be thousands of pounds. Table 3.17F of the WFCM lists hold-down requirements (in pounds) for wall heights ranging from 8 feet to 20 feet. Many anchor types and styles are available and should be designed based on the manufacturer's published anchor capacities. An example of an anchor is shown in Figure 7-11. For load-path continuity, anchors should extend from shear wall to shear wall (if the building has several levels) and eventually into the foundation. Shear wall tie-downs generally resist or transfer vertical loads only; other fasteners are needed to resist the horizontal loads (called *base shear*) that accompany wind or seismic events.

7.4.2.2 Gable End Walls

Gable end wall failures continue to be observed after hurricanes impact structures. The gable end walls are those that are oriented parallel to roof/floor framing and extend past the top plate of the wall framing and up to the roof ridge. Gable end walls do not support the roof and do not benefit from the lateral support that the roof framing provides unless they are joined by structural members or connectors.

Gable end wall construction requirements are reasonably well-detailed for masonry and concrete but less guidance is provided for wood framing. Figure 205E4 of ICC 600 contains a detail of gable end bracing for a masonry wall with a wood-framed gable (see Figure 7-13), but ICC 600 does not provide details on bracing a wood-framed gable atop a wood-framed (or metal stud) wall.

Figure 305J of SSTD-10 indicates that gables should be balloon-framed (with vertically continuous studs across the ceiling diaphragm (see Figure 7-12) and Figure 305K of SSTD-10 shows platform-constructed gable walls (i.e., those constructed with a top plate) but only shows walls being secured to the finish sheathing of the ceiling diaphragm, and not a structural member from the roof-framing system. SSTD-10 Section 306.3 specifies the use of bracing ceiling joists/truss bottom chords with 6-foot-long lateral braces at maximum 6-foot intervals, but the bracing is not shown in the graphic details.

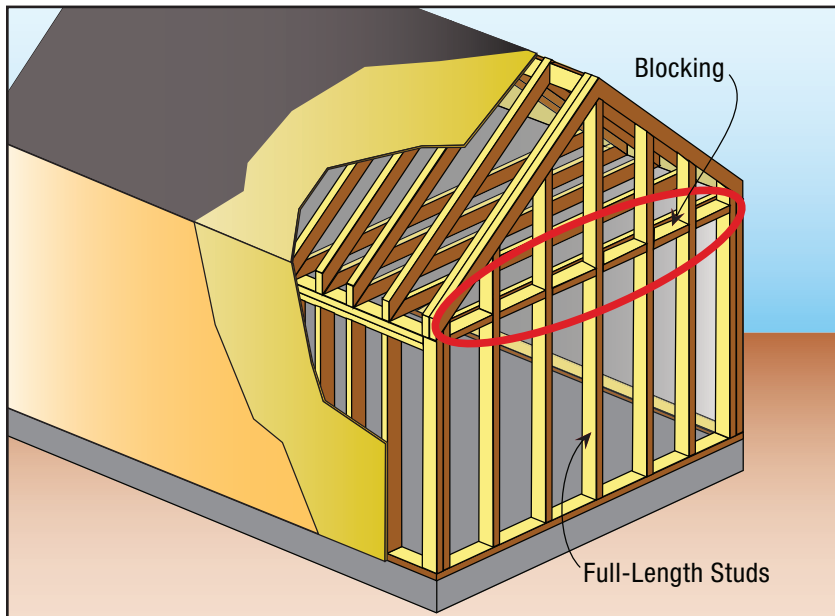

Figure 7-12.
Example of balloon framing.

NOTE

Balloon framing is a construction technique reserved for specific applications and cannot be used in certain applications, due to restrictions on the height of members. It is typically possible for one-story houses, but balloon framing does not usually work for two-story houses.

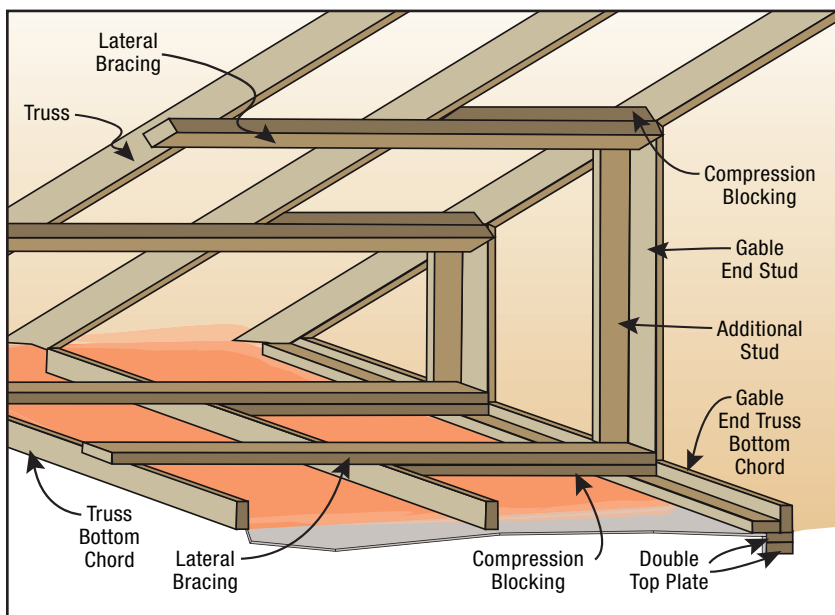

Figure 7-13.
Additional bracing at a gable end wall.

NOTE

Gable end walls may be constructed through a variety of different building materials and techniques, but the discussion presented here is primarily focused on framed construction.

As a best-practices approach, the ceiling diaphragm should be constructed with wood framing and the gable end wall should be braced to that framing. IBHS (Institute for Business and Home Safety), FEMA, and other entities have developed methods to brace wood-framed gables to wood-framed walls. Figure 7-13 provides an example of a gable end wall bracing scenario. (The Hurricane Retrofit Guide, available at <http://www.floridadisaster.org>, provides several examples of various framing situations.)

Taller gables may lack adequate framing to resist wind loads and pressures; bracing the mid-point of longer studs used in tall gable end walls may be necessary in order to meet design loads. Design professionals can design and detail the bracing for taller gable walls.

Gable walls on buildings with cathedral ceilings often have an added disadvantage. With cathedral ceilings, the top plate of the building's gable wall may be offset from the sloped ceiling diaphragm (see Figure 14). When offset, the ceiling diaphragm cannot provide lateral support for the portion of the wall where the top plate is located—an area that is inherently weak and vulnerable to out-of-plane forces acting on the wall.



Figure 7-14.
Improperly braced gable walls.
The ceiling diaphragm (i.e., the bottom chords of the scissor truss) is located several feet above the top of the end wall top plate and no wall-to-truss bracing is provided. (Source: FEMA 549)

To address gable end wall weaknesses that may exist, proper bracing is needed. For conventional framing, augmenting the code-referenced bracing methods with cross-bracing secured to the rafters and ceiling joists (or to the top and bottom chords of roof trusses) is suggested (see Figure 7-13). For buildings framed with cathedral ceilings, two actions are recommended. First, the gable ends should be balloon-framed and constructed so wall studs continue unspliced across the ceiling diaphragm. Secondly, the upper portion of the framing should be braced as detailed for conventional gable ends.

7.4.2.3 Interior Shear Walls and Moment Frames

Occasionally, buildings are laid out in such a manner that insufficient space has been allocated for the constructing of adequate standard exterior shear walls to resist lateral loads. This can occur with relatively long and narrow buildings or when (as in the case of many coastal homes) designers and

homeowners want to maximize the amount of windows installed in a home. In such cases, a few options exist for providing lateral load-resisting systems.

A first option to address the lack of exterior shear walls involves making the exterior shear walls stronger in order to resist greater shear forces. Installing structural panels on both sides of the wall framing can increase (and will typically double) the load capacity in a shear wall. Keep in mind that with larger shear forces, shear forces at tie-downs become greater and adequate tie-down and anchorage become more difficult to achieve.

A second option is to construct interior shear walls. Interior shear walls are typically designed to be stronger (i.e., have more load capacity) than exterior shear walls because interior shear walls resist shears collected from diaphragms located on both sides of the interior shear wall (while exterior shear walls only collect loads from diaphragms on one side). Interior shear walls typically need to be located over foundation walls or over a line of pilings or piers. This is required to ensure that the reactions developed in the shear walls can be adequately transferred to the foundation.

A third option is to construct interior moment frames. Further, moment resistant frames are considered specialized construction and are not addressed in prescriptive codes or standards. To ensure adequacy, therefore, moment resistant frames should be designed by a structural engineer. Once designed by the engineer for the appropriate wind and flood loads, the fabrication of steel moment resistant frames will usually be performed by a subcontractor that specializes in steel fabrication and erection and who should first prepare a set of shop drawings from the design drawings for review by the building department. The contractor and designer should both check the accuracy of the subcontractor's shop drawings. Most moment resistant frames will have to be transported in sections and assembled onsite through field bolting or welding (see Figure 7-15).



DEFINITION

Moment Resistant Frame – A series of columns and beams which resists lateral loading through its ability to bend. Typically utilized in residential construction, moment resistant frames are often used in combination with shear wall systems.

Figure 7-15.
Residential use of a moment resistant frame. (Source: FEMA 55)

7.4.3 Headers, Beams, and Girders

Headers are horizontal beams constructed to support loads over framed openings. Headers are typically required over all openings in exterior walls and over all interior load-bearing walls. Headers support not only gravity loads (e.g., live loads, snow loads, and dead loads) but must also resist uplift loads from wind events (see Figure 7-16).

Tables 3.22A through 3.22E of the WFCM contain header sizes for gravity loads for various building types (single-, two-, and three-story), various building widths (from 12 to 36 feet), and ranges of ground snow loads (from 30 to 70 psf). Table 3.23A provides header sizes for openings in walls exposed to wind loads for 3-second gust wind speeds up to 150 mph. In areas where the 3-second gust basic wind speed is 110 mph or less, gravity loads typically control header size. In areas where the 3-second gust basic wind speed exceeds 110 mph, wind loads may control. Both tables need to be checked and the most restrictive of them should be used to determine header size. Table 3.23A relates to Exposure B conditions; Exposure C conditions are listed in Table A3.23A in Appendix A of the WFCM.

Each end of headers should have uplift connectors to resist wind uplift forces and to complete the load path. The wind forces that connectors must resist in Exposure B areas are tabulated in WFCM Table 3.7; uplift forces for Exposure C areas are tabulated in WFCM Table A3.7. The uplift connections are based upon a roof dead weight of 15 psf (and other criteria that must be met for these tabular values to remain valid for a particular application). It should be noted that these values are conservative for heavier roof structures. For buildings with lighter roof structures, uplift loads need to be determined by a design professional.

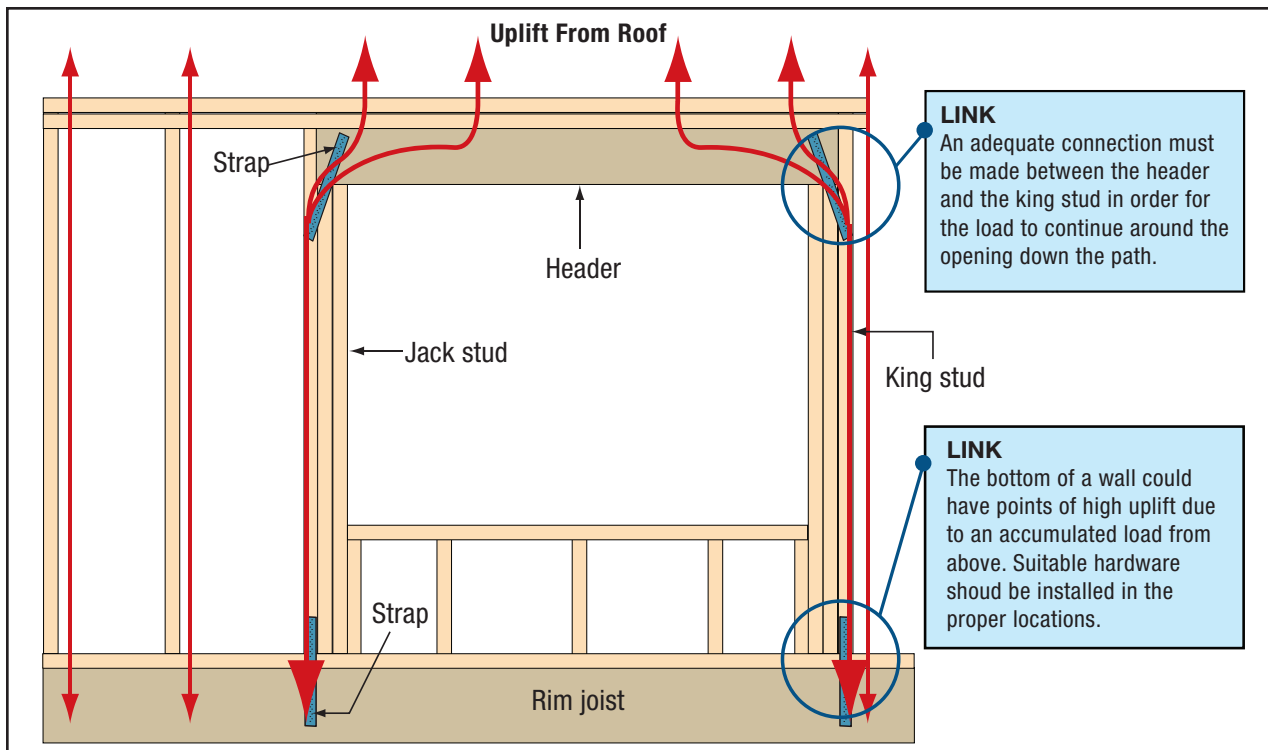

Figure 7-16.
Uplift connections for headers. (Source: FEMA 499)

The bottoms of framed openings for windows also need to be properly connected to resist out-of-plane loads. Window-sill plates are sized in Tables 3.23B (Exposure B) and A2.23B (Exposure C); and lateral forces acting on window sills must also be resisted. These loads are tabulated in Tables 3.8 and A3.8 for Exposure B and C areas, respectively.

Girders are horizontal members which collect loads and support floor framing and floor joists. Girders connect the floor systems to the columns or posts of the foundation. Unlike headers (which are constructed integrally with walls that can resist shear), the girders and posts used in wood-framed construction are typically not parts of the lateral load-resisting system and are used to support gravity loads only.

Table R502.5(1) of the IRC provides prescriptive designs for girders based upon the distance between supports, number of floors supported, and width of the home. The table lists requirements for dimensional lumber and specifies the use of built-up beams with a thickness of up to four plies. The table is based upon simply supported beams where individual members of the beam are spliced over the supports. In the IBC, Tables 2308.9.5 and 2308.9.6 provide wood-header and girder-span requirements for exterior and interior load-bearing walls, respectively. The spans are a function of the building construction type (one- or two-story dwellings), header or girder size, and building width.

Designing built-up beams (where some of the members are used in a continuous manner over the supports) will: 1) result in more efficient designs that require less framing material, and 2) typically result in significant reductions in deflection. Wherever a splice is made, the spliced member does not contribute to beam strength, so correctly locating splices is critical for ensuring proper performance. Splices need to be placed in locations where induced moments in the beam are low. Engineers should design beams that are considered to be continuous over supports and should detail where splices in the individual members are located. Continuous beams carry moment forces in the beams across the top of the supporting post or column. By contrast, simply supported beams have zero moment at the supporting post or column.

7.4.4 Concrete, Masonry, and ICF Walls

The use of walls constructed from reinforced concrete or concrete masonry units (CMU) is becoming more prevalent in communities impacted by hurricanes. When properly designed and constructed, these styles of walls can perform well when exposed to high winds. Typically, concrete and CMU construction is used in conjunction with wood-framed roofs and, in the case of multi-story buildings, wood-framed floors. Concrete and masonry walls lack the thermal performance required by the IRC and typically require framed walls or thick furring to allow the addition of sufficient insulation. But with the advent of ICF (Insulated Concrete Form) wall sections, sufficient thermal and structural performance can be obtained with a single, reinforced concrete-wall section because its permanent insulating form remains in place. Figure 7-17 illustrates a well-designed masonry wall system.

NOTE

Insulating Concrete Forms (ICF) are used in a construction technique that utilizes pre-formed blocks or panels to form a pre-insulated wall system that relies upon concrete for its structural integrity. More information about acceptable ICF applications is available in the IRC.

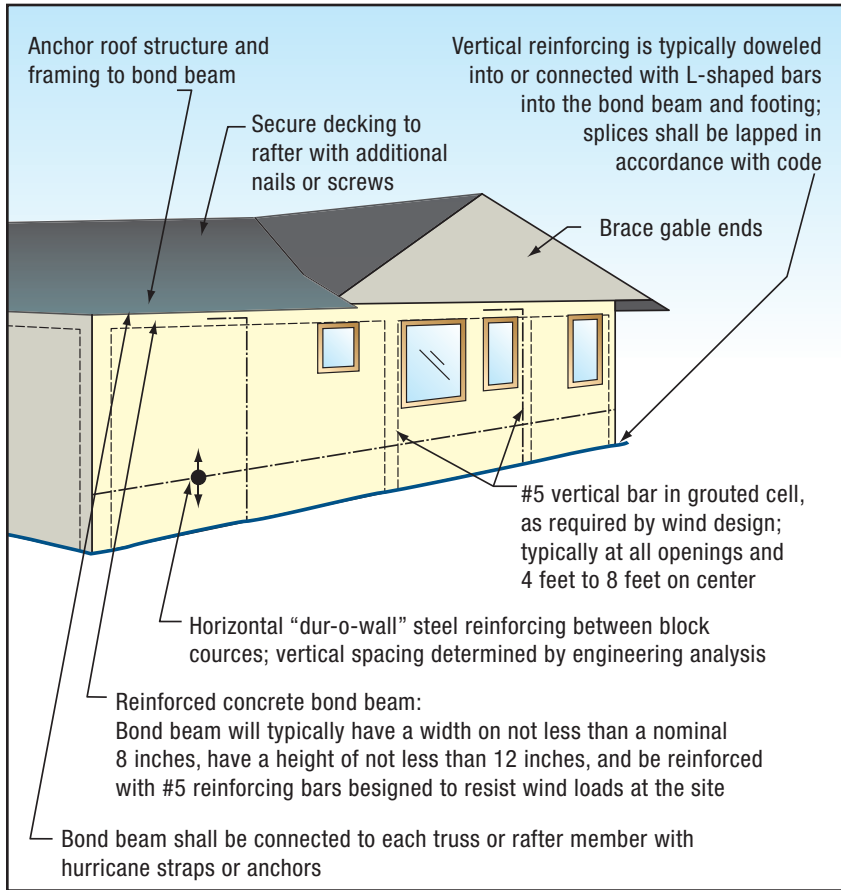

Figure 7-17.
Design of a reinforced masonry wall system.
(Source: FEMA 488)

Requirements for masonry shear walls are specified in Sections R606, R607, and R608 of the IRC. The IRC contains some prescriptive designs for masonry walls (e.g., wall reinforcement, minimum width of walls, rafter and joist connections, and floor diaphragm connections), however, there will be some aspects of masonry construction that will need to be designed. For example, IRC Section R606.12.2.2.1 requires that connections to shear walls be designed in accordance with the performance standard ACI 530/ASCE 5/TMS 402, *Building Code Requirements for Masonry Structures*. Requirements for ICF construction are provided in IRC Section R611. The prescriptive designs for ICF are well-developed and detailed.

Examples of prescriptive designs for concrete and masonry walls in high-wind regions are contained in Section 205.5 of ICC 600. It is important to note that reinforcement is specified for walls both parallel to and perpendicular to the roof ridge for one-, two-, and three-story buildings. Prescriptive ICF designs that meet high-wind requirements of the IRC may be found in Section 209 of ICC 600.

Information on wall-framing inspection points can be found in FEMA 55 Table 13.5: *Wall Inspection Points*. This table provides the official with common items that should be inspected or observed in wall-framing construction, as well as a summary of the topics described within this section.

7.5 Floor Construction

People are generally quite aware of the floors on which they live and work. People notice the squeak of a loose floorboard, feel the softness of plush carpet, and experience the fatigue that results from standing on hard concrete slabs. Many people are unnerved when floors give or deflect too much under foot

traffic. What many people are not aware of is the structural importance of floor systems. In addition to supporting a building's occupants, floor systems are critical components in resisting lateral loads.

Floors (and ceilings) function as diaphragms and collect lateral loads that have been exerted on a building's exterior from wind or flood forces. Floor systems transfer loads either to shear walls in the stories below or, in the case of the lowest floor, to the foundation. Floors and ceilings prevent torsional racking of the building and together constitute a major component of that building's structure.

Older versions of prescriptive codes and standards concentrated on floor construction that resisted gravity loads. Emphasis was placed on the proper sizing of floor joists for adequate strength and deflection control (because deflection of the floor is often the governing criteria when selecting member sizes, spacing, and the maximum span of floor joists). Newer codes and standards (i.e., those issued after 1990) place an increasing emphasis on lateral loads. Details are provided (in the form of prescriptive or performance requirements) to ensure that floor systems function as diaphragms and adequately transfer loads through the structure.

It is recommended that buildings be constructed higher; the NFIP requires structures built in A Zones be elevated to at least the BFE and that all materials below the BFE be flood-resistant. In floodprone areas, elevated wood framed floors, floor joists, floor decking and insulation all need to be flood resistant if they are not elevated above the BFE. This criteria typically requires the framing and flooring to be treated to resist moisture and decay and precludes the use of fiberglass batt insulation.

7.5.1 Floor Framing and Sheathing

Like roof framing, floor framing typically consists of dimensional lumber spanning an open area; these members are called floor joists. The use of engineered wood products such as floor trusses and I-joists (see Figure 7-18) is becoming more common in floor framing, especially when long, open areas are desired beneath the elevated floor. For dimensional lumber, design professionals can determine joist sizes or they can be determined using span tables, such as those contained in the AF&PA's *Span Table for Joists and Rafters* or the WFCM. The IBC also contains span tables for a variety of lumber species and loading conditions.

As mentioned, the use of floor trusses and I-joists is becoming more prevalent in floor-framing systems in many parts of the United States. The proper installation of these materials may require additional steps. For example, some I-joists require solid blocking to prevent web crushing under bearing walls (such as where a wall above is being supported by a floor without the use of a beam or girder). Where longer-span floor framing is installed, blocking is needed for lateral support, as is typical in longer-span dimensional lumber floor-framing applications. When using any engineered product, the manufacturer's installation procedures must be followed to ensure that the system functions as designed.

Floor joists must also be sized to resist dead loads (i.e., the weight of the floor system including joists, floor sheathing, and flooring, plus any permanent attachments) and live loads. In addition, maximum allowable deflections corresponding to beam length are specified in the code and material standards. It is important to note that, in most cases, floor-framing deflection limits are more stringent than roof-framing deflection limits.

Perimeter framing of the floor system must prevent the floor system from racking and function as a collector to transfer forces to the shear walls or foundation below. The IRC, ICC-600, and the WFCM all contain prescriptive requirements for blocking and for connections to walls plates (located above) and sill plates (below).

Gravity and live loads typically control the design or specification of the thickness of floor sheathing. In addition, floor sheathing must be constructed in a fashion to create diaphragms that resist lateral loads. Section 503 of the IRC specifies boards and structural panels to be used as floor sheathing for various joist spacing and floor live loads.

The provisions of prescriptive codes and standards generally address most floor construction situations. They cover many issues that typically arise in a coastal environment. One area, however, where the provision of additional details is warranted concerns the protection of metal fasteners against salt spray. While much discussion on corrosion protection has gone into code development, the corrosion of metal building elements under elevated structures remains a potentially serious problem. Fasteners under elevated structures are exposed to salt spray but are not exposed to the cleansing action of rain. Also, the undersides of elevated structures are not exposed to sunlight and can remain damp longer because of their sheltered location. The use of hot-dipped galvanized fasteners provides connectors with a reduced rate of corrosion (when compared to untreated connectors). But since portions of the galvanized areas are often damaged when nails are driven, even galvanizing is not considered fully effective in resisting corrosion. Stainless-steel connectors provide the most corrosion resistance offered in a metal connector, but the availability of stainless-steel fasteners and framing connectors is limited in some areas.

One method to reduce exposure to salt spray is to sheath the undersides of floor-framing systems in order to enclose the space where connectors are located. Plywood sheathing (at least 1/2-inch thick) is recommended and should be installed to enclose the floor-framing system. Sheathing should be scribed around utility and framing penetrations to reduce the infiltration of salt-laden air. Methods that allow portions of the sheathing to be removed to allow periodic inspection should also be considered and incorporated into any design. Further, since metal-plate wood trusses may become unstable under gravity loads when their metal plates lose strength, metal-plate wood trusses should not be used in coastal environments unless corrosion is adequately controlled.

Information on floor-framing inspection points can be found in FEMA 55, Table 13.4: *Floor Framing Inspection Points*, which provides the official with common items in floor-framing construction that should be noted, as well as a summary of topics described in detail within this section.



Figure 7-18.
Wooden I-joists used for floor framing. (Source: FEMA 55)

Roof Coverings and Best Practices

8.1 Introduction

During storm events, a roof is expected to perform many functions—from preventing water intrusion to acting as a structural diaphragm in certain situations. As stated in the 2006 IBC, roofs must serve to protect the building. This requires roofs to resist high and low temperatures, rain, wind-driven rain, high winds, exposure to ultraviolet radiation, and (in some areas) snow, ice formation, and hail stones. In coastal areas, high winds and the hazards that often accompany high winds (such as windborne debris and wind-driven rain) can prove particularly problematic, as this is not specifically addressed by the codes (despite a few exceptions). Corrosion from salt-laden air can also be a factor in the performance of roof coverings as materials, systems, or fasteners can be weakened from extensive corrosion. Roof systems typically fail when winds produce forces greater than the roof's strength. Winds can tear roof coverings from roof decks and can tear roof decks from framing. Roofs can also fail if punctured by wind-borne debris. In most cases, debris punctures are less of a problem on residential structures where the roof's slope limits the amount of rain that can enter a puncture (unless the puncture occurs in a valley or other areas of the roof where water is channeled or collected). However, in buildings with flat or low sloped roofs, punctures from wind-borne debris can be devastating.

Roof systems (ranging from roof coverings to structural members) typically fail when winds produce forces greater than the capacity provided by the elements of the roof system. Winds can tear roof coverings from roof decks and can separate roof decks from framing. Roofs can also fail if punctured by windborne debris. In most cases, debris punctures pose less of a problem on residential structures, where a roof's slope may limit the amount of rain that can enter a puncture (unless that puncture occurs in a valley or other area of the roof where water is channeled or collected). However, in buildings with flat or low sloped roofs, punctures from windborne debris can lead to extensive interior damage.

Historically, damage to roof coverings is the leading cause of building problems during hurricanes and other coastal storm events. High winds and windborne debris can damage the roof covering and rains that accompany those high winds can enter the building, soaking its contents and interior (Figures 8-1 and 8-2). After water enters a building, excess moisture becomes trapped within the building and mold can grow unchecked unless actions are taken quickly to secure and dry the building. Roof problems can occur in any area; in coastal environments that have higher wind speeds and greater potential for torrential rains, problems resulting from roof system damage and failures are more prevalent.



Figure 8-1.
Instance where wind pressures exceeded the strength of the asphalt roofing. (Source: FEMA 549)

Roof systems can also fail if roof-mounted equipment is damaged or dislodged by high winds. During Hurricane Katrina, loss of mechanical equipment caused the majority of water damage that was observed in several buildings. In some of those buildings, structural roof damage itself was quite minimal yet the buildings experienced extensive water damage.



Figure 8-2.
GULFPORT, MISSISSIPPI:
Winds dislodged roof mounted equipment and created large openings in the roof system. (Source: FEMA 549)

There are many parameters to consider when good roof performance is desired. Although this process begins with the proper selection of the roof system for that particular environment, there are other important factors to consider, such as the roof covering, deck, ends, underlayment, flashing, and other components. Proper roof installation is achieved through experience and sound construction techniques, thorough inspections, and compliance with code requirements, standards, and manufacturer recommendations. Other steps can be taken to produce roofs that can perform better than code-mandated systems. Those steps, often called “best practices,” will be discussed in the following sections.

8.2 Roof Coverings – General Code Requirements

Building codes provide requirements for the design and installation of roof coverings. Roof coverings are addressed in Chapter 15 of the IBC and Chapter 9 of the IRC. Both codes provide requirements for roof coverings commonly used on high-sloped roofs (such as asphalt shingles, clay and concrete tile, wood shakes and shingles, and metal roofing) and for roof coverings typically used for low-slope applications (such as built-up roofing, thermoset single-ply roofing, thermoplastic single-ply roofing, sprayed polyurethane foam roofing, and liquid-applied coatings). Both codes also contain requirements for roof decks, underlayment, flashing, structural performance, and materials and testing criteria. Requirements for roof coverings installed in high-wind areas (i.e., where the basic wind speed is 110 mph or greater) are provided. Further, both codes contain provisions for re-roofing existing buildings, which will be discussed later in this chapter.

NOTE

The FEMA MAT reports for hurricanes Charley (FEMA 488), Ivan (FEMA 489), and Katrina (FEMA 549), along with FEMA 499 provide extensive and updated examples of roof covering best practices originally presented by FEMA in the *Coastal Construction Manual* (FEMA 55).

Chapter 5 of SSTD 10 contains requirements for the installation of asphalt shingles and concrete roof tiles in high-wind areas. It is important to note that the requirements apply only to shingle and tile fastening and do not address underlayment, flashing, and other roof-covering components. Test standards such as ASTM D7158 are available to provide performance metrics for asphalt shingles. The new ICC-600 standard is the residential design standard for hurricane-resistant construction, replacing SSTD 10, and to reference the ASTM D7158 standard.

While the IRC is generally considered a prescriptive code, many of the roof-covering provisions are performance-based and mimic those contained in the IBC. The performance of more research has been recommended in recent FEMA MAT reports in order to understand and identify acceptable systems and appropriate (i.e., compliant) installation techniques for residential applications.

The technical nature of these roofing systems, and how they rely upon installation for code-compliance and warranty compliance, is often much more involved than other aspects of residential construction (such as wall and roof framing or foundation construction). The codes often rely upon the use of the manufacturer’s installation instructions to ensure proper installation. For many areas of construction, the codes state that roof covering must be installed per the manufacturer’s installation instructions. Instructions should be available onsite so that the proper installation of the roof covering can be achieved and verified. To facilitate the transfer of this information, it is common to see manufacturer’s installation requirements printed on the roof packaging itself.

8.2.1 IRC Roof Covering Requirements

General. The IRC addresses roof covering requirements in several areas. Fire resistance is covered in Section R902 and insulation is addressed in Section R906, but the majority of the requirements are presented in Section R903 and R904, which address weather protection and materials, respectively. Requirements for individual roof covering systems (e.g., asphalt shingles, clay or concrete tile, etc.) are listed in Section R905.

Load and pressure requirements are contained in Section R301. Section R301.2.1 requires that roof coverings resist the C&C loads listed in Table R301.2(2) as a function of basic wind speed and roof slope. Table R301.2(2) lists pressures for Exposure B conditions with mean roof heights of 30 feet or less. The pressures must be adjusted for other heights and exposures by factors listed in Table R301.2(3). This section provides the required loads that all components of a roof system (such as roof covering, roof deck, etc.) must be designed to resist the full C&C wind loads. Some exemptions exist for air permeable cladding and other roofing components, provided they have been certified by testing.

Roof Decks and Underlayment. The IRC generally requires roofing to be installed on continuous sheathing. Spaced sheathing is allowed for some metal roofing systems (specifically those listed for use on spaced sheathing) and for some wood and tile shingles (in areas where an ice barrier is not required). Building officials and builders should keep in mind that Chapter 9 of the IRC pertains to roof assemblies only and does not address structural system compliance for load-carrying systems such as diaphragms. While the use of spaced sheathing may be allowed beneath some roof covering systems, it may not satisfy structural diaphragm and bracing requirements contained elsewhere in the code. A conscious decision must also be made whether spaced sheathing is an appropriate system to use, based upon the roof slope.

When complying with the IRC, most roofing systems will require two layers of underlayment when the roof slope is between 2:12 and 4:12. Roof slopes greater than 4:12 require only one layer of underlayment. Underlayment in high-wind areas (i.e., where wind speeds are 110 mph or greater) must be secured with corrosion-resistant fasteners spaced no more than 36 inches apart.

As a best-practices approach, an augmented underlayment can provide an effective secondary roof barrier to reduce water penetration in the event that the primary roof is damaged by wind or windborne debris (see Figure 8-3). FEMA 499, Technical Fact Sheet No. 19: *Roof Underlayment for Asphalt Shingle Roofs*, provides guidance on improving the performance of roof systems by augmenting underlayment installations.

NOTE

ASTM D 3161 tests samples of asphalt roofing shingles for exposure to high winds. This is accomplished by conditioning the samples (in order to seal their self-sealing strips) and then exposing them to an air stream. The conditioning involves heating the samples between 135° F and 140° F for 16 hours. After conditioning, the samples are cooled to between 70° F and 80° F and are then exposed to air-stream testing for 2 hours. The test involves blowing a stream of air across the test sample from three different directions. Shingles that restrain tabs from lifting, disengaging, or being torn loose pass the test.

ASTM D 3161 lists two types of asphalt shingles (Type I and Type II) and three wind speeds (Class A, D, and F). Type I shingles have self-sealing tabs; Type II shingles have interlocking tabs. Class A shingles pass the ASTM test with a simulated wind speed of 60 mph, Class D shingles pass the test at 90 mph, and Class F shingles pass at 110 mph. While the IRC requires that shingles needing special fastening be considered Class F, the ASTM standard itself does not contain special fastening methods.



Figure 8-3.

Example of an augmented underlayment installation that helps provide a secondary barrier against water intrusion during a storm event. (Source: FEMA 488)

Asphalt Shingles. The IRC permits the installation of asphalt shingles on continuous sheathing for roofs with slopes as low as 2:12. When this covering is installed on roofs sloped between 2:12 and 4:12, two layers of underlayment are required. Roofs with slopes greater than 4:12 require only one layer of underlayment. Section R301.2.1 requires that asphalt shingles be designed in accordance with Section R905.2.6, which permits asphalt shingles classified using ASTM D 3161 to be installed in areas with basic wind speeds below 110 mph. Areas with wind speeds of 110 mph or higher require special fastening methods. Special fastening is also required for roof pitches greater than 20:12. Special fastening requires shingles that are classified using ASTM 3161 be considered Class F. Recommendations on the required special fasteners should be attained through the shingle manufacturer.

ASTM D 7158 is a relatively new standard for certifying asphalt shingles with self-sealing strips for uplift resistance. The test combines physical testing (similar to wind-tunnel testing) and an analytical approach to determine wind speed resistance ratings. During certification, shingles are provided with pressure taps that allow pressure measurements to be taken at selected locations. The taps are provided to measure pressures at exposed portions of the shingle as well as concealed portions of the shingle (i.e., at the underlayment). Exposed and concealed taps are placed both above and below the self-sealing strip. The shingle assembly is then exposed to relatively low wind speeds (approximately 35 mph) and pressure measurements to determine external pressures (those above the shingle) and internal pressures (those at the underlayment). These low-speed tests provide external and internal pressure coefficients that are combined into an uplift coefficient. The coefficients are used to determine the uplift force that each shingle tab will experience for a given wind speed. The shingles are then mechanically tested to determine their tab's resistance to uplift. Shingles with tabs strong enough to resist the factored uplift force for a given wind speed are certified for that wind speed by class. ASTM D 7158 lists three classes of shingles:

NOTE

There are a few nuances of ASTM D 7158 that remain of interest to building officials, designers, and builders. These nuances include: building occupancy category (from ASCE 7-05 Table 1-1), topographic effects, and mean roof height. The tab uplift calculations used in ASTM D 7158 are appropriate for Category I and Category II buildings (i.e., non-critical and non-essential facilities) that are less than 60 feet tall and located in areas not exposed to topographic wind effects (i.e., the ASCE 7-05 Chapter 6 topographic effect factor K_{zt} equals 1.0). If asphalt shingles are to be used on Category III or Category IV buildings, buildings higher than 60 feet tall, or buildings exposed to topographic effects, the shingle certification must use higher uplift forces.

- Class D shingles pass tests with basic wind speeds up to and including 90 mph.
- Class G pass tests with basic wind speeds up to and including 120 mph.
- Class H pass tests with basic wind speeds up to and including 150 mph.

This new standard has yet to be referenced by the IRC or IBC, but is recognized by ICC-600. ASTM D 7158 cannot be used to certify Type II shingles (i.e., those with interlocking tabs). Type II shingles will need to be tested per current ASTM D 3161 tests.

As previously stated, manufacturer's installation instructions need to be followed to ensure proper installation and, in some instances, code compliance. Post-disaster MAT investigations have noted that two errors are often made in regard to the shingle installation technique. These two errors often result in the failure of the roof covering during high-wind events.

The first common installation error concerns the improper installation of the starter strip (see Figure 8-5). For proper bonding of the self-sealing strips, the starter course must be rotated 180 degrees and the tabs must be cut off. If the tabs are not removed, they will prevent the self-sealing strip from functioning. Figure 8-4 is an example of proper shingle installation methods.

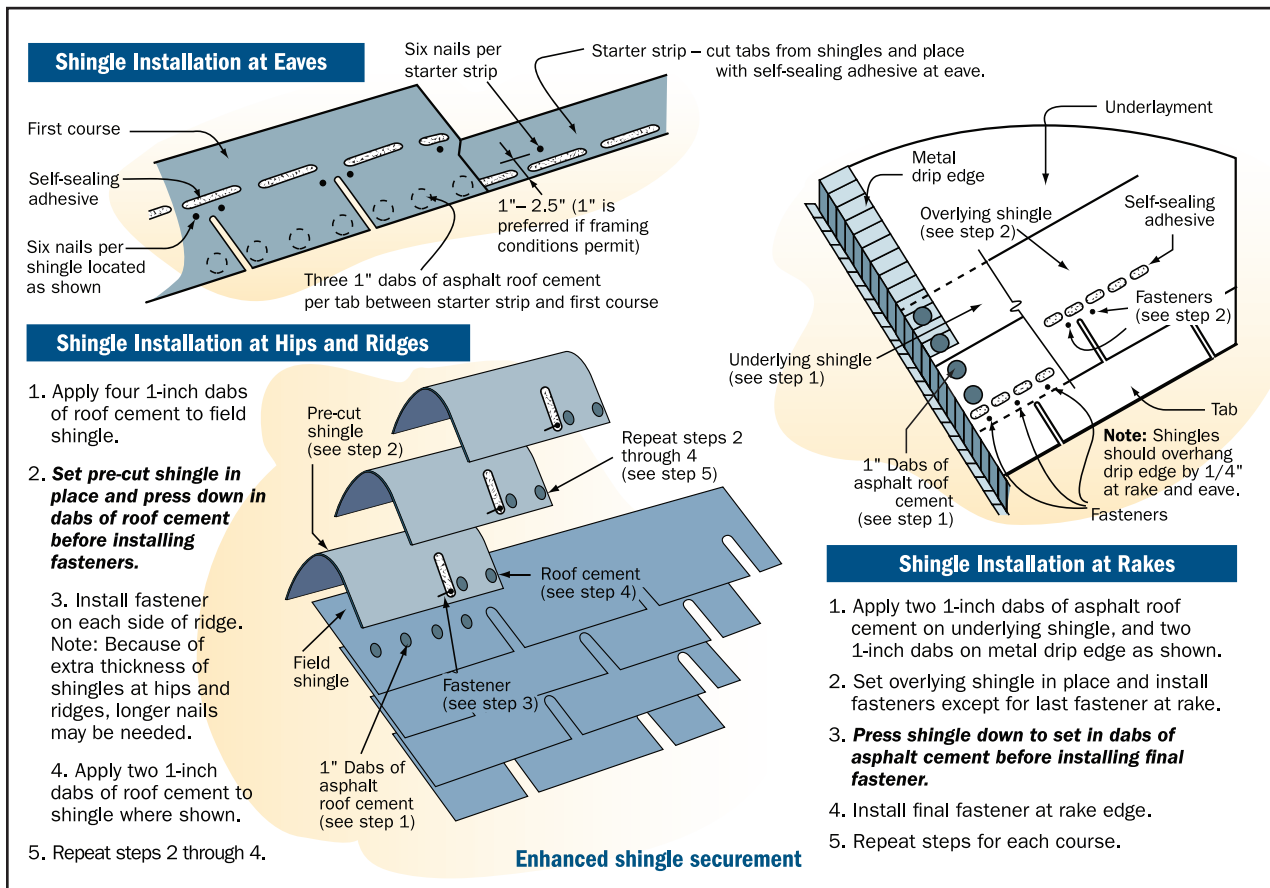

Figure 8-4. Example of proper shingle installation. (Source: FEMA 499)

The second common installation error occurs when shingles are installed in vertical sections. While this method allows roofers to traverse back and forth across the roof less, it may not allow for all of the shingles to be properly nailed. The ends of shingles installed after the first column of shingles can likely not be nailed without meticulously lifting the tabs of shingles that have already been fastened. This procedure, called raking, has been identified by MAT investigations in numerous failures involving asphalt shingle roofs during high-wind events and is attributed to the shingles having been damaged and improperly nailed. Figure 8-6 demonstrates an example of shingle failure attributed to raking. An example of improper shingle installation is also shown in Figure 8-7.

FEMA 499, Technical Fact Sheet No. 20: *Asphalt Shingle Roofing for High-Wind Regions*, provides guidance on asphalt shingle installations. Many of the recommendations presented are similar to those described in the installation instructions provided by many manufacturers.



Figure 8-5.
Roof failures that resulted from improper starter-strip installation. (Source: FEMA 549)



Figure 8-6.
Roof failures that resulted from asphalt shingles being installed in a raking fashion. (Source: FEMA 489)



Figure 8-7.
Loss of asphalt shingle roofing along hip. Best Practices approaches contained in Technical Fact Sheet No. 20 help prevent this mode of failure. (Source: FEMA 489)

Clay and Concrete Tile Roofing. The IRC permits the installation of concrete or clay tile on roofs with slopes as low as 21/2:12. Tile-roofing underlayment requirements are similar to asphalt roofing surfaces; two layers of underlayment are required for low-slope applications and additional fastening for the underlayment is needed for areas with basic wind speeds of 110 mph or greater. Section 905.3.7 requires clay and concrete roof tiles to be installed per manufacturer instructions when used in areas where the basic wind speed is 100 mph or greater and in all areas where the tiles are installed more than 40 feet above grade.

FEMA (and other entities that have conducted post-disaster investigations since Hurricane Andrew struck Florida in 1992) have noted that tile roof coverings have not performed well during several high-wind events. Although performance of these roof covering systems has improved since Hurricane Andrew (due largely to better design and construction guidance from the manufacturers), roof covering systems still frequently fail during hurricanes. The performance of mortar-set tile roof systems continues to be very dependent upon the quality of the installation. This installation method has consistently been observed during MAT investigations to not perform as well as other tile installation methods. Tiles also remain vulnerable to being damaged by windborne debris because they are considered brittle coverings. When clay or concrete tiles are impacted by windborne debris, they commonly break and leave the underlayment exposed to high-wind forces it was not designed or constructed to resist (see Figures 8-8 and 8-9). This condition has been observed to lead to a progressive failure of the roof covering across the roof surface. Also, once damaged, it is important to note that the tile shards can become airborne, adding debris to the wind field. This debris may cause damage to the building itself as well as damage to downwind buildings.



Figure 8-8.
Clay tile roof failure. The tiles were dislodged due to inadequate anchorage. (Source: FEMA 549)

Adequate design, testing, and installation can significantly reduce the potential for tiles to be dislodged, but vulnerability to debris damage remains. FEMA 499, Technical Fact Sheet No. 21: *Tile Roofing for High-Wind Areas*, provides guidance for installing tile roofing systems within coastal areas.



Figure 8-9.
Storm damage to a tile roof system.
(Source: FEMA 488)

Wood Shingles and Shakes. Sections 905.7 and 905.8 contain the requirements for wood shingle and shake coverings. Roofing can be installed on solid or spaced sheathing, but solid sheathing is required where ice dams or low temperatures require an ice shield. Wood shake installations differ from wood shingle installations particularly in their underlayment and rake installations. Due to the irregular surface of wood shakes, an interlayment layer of 30-pound roofing felt is required to improve weather tightness. This interlayment layer is applied between each course.

The IRC does not contain prescriptive requirements for shingles and shakes used in high-wind regions. Although they are not specifically cited, shingles and shakes must satisfy the wind-loading requirements of Section R301.2.1. In order to verify proper installation techniques, users of these products should consult with the shingle or shake manufacturer or the Cedar Shake and Shingle Bureau for installation instructions required to satisfy the wind load requirements in areas where the basic wind speed exceeds 100 mph.

Metal Shingles and Metal Roofing Panels. Section R905.4 discusses metal roofing shingles and Section R905.10 covers metal roofing panels. The area exposed to weather distinguishes shingles from panels. Shingles offer less than 3 square feet of weather exposure per shingle; panels have exposures of 3 square feet or more.

Metal shingles and panels can be installed on solid sheathing, spaced sheathing, or purlins — except where the roof covering is designed for spaced supports. As previously stated, when roof coverings are installed upon decking that is not solid, the requirements of Chapter 9 of the IRC do not apply, as the IRC does not address roof diaphragms. Requirements for structural stability need to be checked for compliance with other portions of the code. For these systems, bracing will need to be installed to provide the code-required structural stability (described by engineers and designers as diaphragm action). An exception in the code is provided when the metal roof covering is designed to act as a structural diaphragm and when it is installed on spaced supports or spaced sheathing.

The IRC states that the minimum roof slope for metal shingles is 3:12. The minimum slope for metal panels depends upon the methods used to join the panels. Lapped, non-soldered panels have the same slope requirements as metal shingles and can be used on roof decks with slopes as low as 3:12. Lapped panels joined with an applied lap sealant can be used for slopes as low as 1:12. Standing-seam roofing can be used on roof surfaces with slopes as low as 1:12. Table R905.10.3(1) lists material requirements for metal roof panels (these requirements also apply to metal roof shingles).

The IBC does not include prescriptive fastening designs for metal shingles and metal roof panels. While the IRC does not specifically address the use of metal shingles and metal roof panels in high-wind areas, the manufacturer should be consulted to determine fastening and other installation requirements for basic wind speeds exceeding 100 mph. It is notable that MAT investigations from 1998 to 2008 continue to observe good performance of metal-panel roof systems.

Roof Coverings for Low-Sloped (< 1:12) Roofs. Modified bitumen roofing, thermoset, and thermoplastic single-ply are approved for nearly flat roofs. IRC Sections R905.11, R905.12, and R905.13 outline the requirements for these types of roof covering.

The requirements focus on material specifications and application of the roof covering. Modified bitumen membranes are typically fully adhered and, when installed on a properly constructed roof deck, can perform well during high-wind events. Single-ply systems, however, have been observed to perform poorly when exposed to high winds, particularly if these systems are not fully adhered. When used in areas where the basic wind speed exceeds 100 mph, single-ply systems should be fully adhered.

With all membrane systems, care must be taken along the edge and corner zones of the roof, where wind turbulence creates high localized uplift pressures. Post-event MAT assessments have determined that roofing failures commonly begin at the edges or corners of the roof, when insufficient attention is given to fastening, flashing, and coping.

8.2.2 IBC Roof Covering Requirements

The IBC requirements for roof coverings are similar to those included in the IRC. Like the IRC, much emphasis is given to weather protection. However, emphasis is also given to the fire ratings of roof coverings.

Section 1504.1 states that the roof coverings must be designed to resist the wind load requirements of Section 1504 and Chapter 16. Chapter 16 states that the wind load requirements for roof coverings unless specified otherwise are to comply with wind pressures based upon ASCE 7.

The requirements for installation of asphalt shingles in the IBC are the same requirements as those contained in the IRC. The IBC requirements are listed in Section 1540.1.1. Clay and concrete tiles are treated similarly but an alternative procedure for determining and certifying wind resistance is allowed by Section 1504.2. The alternative procedure is similar to the new procedures of ASTM D 7158, which are described earlier in this chapter and specified for self-sealing, asphalt shingles. Like the procedures of ASTM D 7158, the alternative procedure does not address critical or essential facilities and its applicability is limited to buildings 60 feet tall or lower.

The deck and underlayment requirements of the IBC are similar to those contained in the IRC. The IBC does exempt ice membrane requirements for underlayment when used on detached accessory buildings that are not heated.

8.2.3 IBC Requirements for Aggregate Ballast (Gravel and Stone) Roof Coverings

High winds can dislodge aggregate ballast (e.g., gravel and stone) from roofs. Once dislodged, the roof ballast can become airborne with sufficient energy to damage downwind buildings. Buildings with unprotected glazing are particularly vulnerable.

Since 1972, researchers have been observing damages to glazing on high-rise buildings located next to or in close proximity to structures with stone or gravel roofs. These damages have been attributed to the aggregate being dislodged and blown into the glazing of the adjacent building. FEMA observed several instances of this behavior in New Orleans after Hurricane Katrina. (See FEMA 549 and FEMA 543 for additional information.) The 2000 IBC and ASCE 7-95 identified wind hazard areas known as windborne debris regions. Since then, these regions have been mapped to delineate areas near the coast where windborne debris issues can affect not only glazing, but the structural integrity of the building, as well. Subsequent versions of the code have included specific requirements that address measures to mitigate damages.

IBC Section 1504.8 provides requirements for aggregate ballast on roof systems. The section precludes the use of aggregate ballast on roofs in hurricane-prone regions (i.e., areas where the basic wind speed is 120 mph or higher). In areas with a lower basic wind speed, Table 1504.8 places restrictions upon the exposure categories for aggregate ballast at wind speeds less than 120 mph and limits on the heights of roofs that use aggregate ballast for buildings sited in higher exposure categories. For example, when a building is sited in Exposure C areas where the basic wind speed is 85 mph, Table 1504.8 prohibits the use of aggregate surface coverings when the mean roof height exceeds 60 feet.

The values listed in Table 1504.8 of the IBC denote the maximum allowable mean roof height permitted for buildings with gravel or stone roofs in areas outside of a hurricane-prone region. Presently, this table does not take into account the size or density of the gravel or stone. In addition, it does not account for the effect of roof parapets, which can significantly augment the turbulence. Recent anecdotal information suggests this table should take into account these important phenomena. However, more research tests and quantifiable results need to be conducted before a code revision can be considered.

Section 1504.4 of the IBC requires low-slope aggregate-surface roof systems to comply with ANSI/SPRI *Wind Design Standard for Ballasted Single-Ply Membrane Roofing* (RP-4). RP-4 contains provisions that allow aggregate ballasted systems to be installed within some windborne debris regions. The requirements depend upon a number of factors including the basic wind speed, exposure, presence and height of parapets, and method by which the aggregate is secured.

8.2.4 Roof Vents

Roof vents pose a design and construction challenge because they are located where the roof covering and roof sheathing may be separated. If the vents are not properly installed, water may find its way beneath the roof covering, causing roof covering failures or (potentially) total roof system failures. The Florida Department of Community Affairs (DCA) Web site contains recommendations to improve the performance of ridge vents, off-ridge vents, and turbine vents. These and other recommendations are available at <http://www.floridadisaster.org/mitigation/rcmp/hrg>:

- The DCA Web site suggests inspecting off-ridge vents to see if they are loose.
- Check for the presence of fasteners anchoring turbines to the round duct that penetrates the roof.
- Check to make sure that the duct is secure.
- Check around all pipes that penetrate the roof and ensure that the flashing around the pipe is sealed to the pipe without any gaps or cracks.

In addition, it is important to determine the spacing and size of nails or screws used to hold down ridge vents, off-ridge attic vents, turbines, and any kitchen or bathroom vents that protrude through the roof. This inspection is performed in order to determine if the appropriate nails were used and if they were driven in the correct locations. Many times roofers use the same length nails to fasten these elements as they use to fasten the shingles. In most situations, a longer nail will be required for adequate anchorage of these items. If longer nails are used and they stick far enough through the roof deck, the anchorage can be improved by clinching the nails (i.e., using a hammer to bend nail heads over) from inside the attic.

8.3 Re-Roofing Code Requirements & Best Practices

Section 1510 of the IBC and Section 907 of the IRC address roof covering replacement. The IBC refers to this as *re-roofing* the IRC as *re-covering*.

The IRC and the IBC generally require re-roofing to meet the requirements of new roof installations. One notable exception to these requirements concerns the slope of the roof. Re-roofing does not need to meet the slope requirements for a new roof if that roof provides positive drainage.

IBC Section 1510.3 requires old roofing to be removed before installing a new roof covering, as stated below:

1. *Where the existing roof or roof covering is water soaked or has deteriorated to the point that the existing roof or roof covering is not adequate as a base for additional roofing*
2. *Where the existing roof covering is wood shake, slate, clay, cement, or asbestos-cement tile.*
3. *Where the existing roof has two or more applications of any type of roof covering.*

There are exceptions to tear-off requirements for complete and separate roof systems that can transmit roof loads directly to the building's structural system. These requirements are applicable to metal

panel, metal shingle, and concrete and clay tile roof coverings over wood shake roofs, as well as for new roofing over an existing sprayed polyurethane foam system.

Some state-specific codes contain requirements for re-roofing. For example, the Florida Building Code (FBC) has more stringent requirements for roof coverings within its High Velocity Hurricane Zone (HVHZ) than are required for other portions of the state.

The HVHZ re-roofing section requires a greater level of inspection and restrictions when re-roofing. Re-roofing without tear-off of the existing roof covering is allowed but applications are limited. For example, FBC section 1521.17 allows asphalt shingles to be installed over an existing layer of shingles only when not more than $\frac{1}{8}$ inch difference in level of the existing shingle material exists.

A re-roofing project provides a perfect opportunity to improve existing buildings. When a roof covering is removed, access is created to roof decking and other building components (particularly fasteners) that typically remain concealed and inaccessible otherwise. During these projects, the load path from the top of the wall to the roof deck may be upgraded, new connectors may be installed, and new flashing and underlayment may be installed. Even though many of these best practices are not required by the codes, a number of them should be completed during a re-roofing effort. The following list applies to many roof systems, but is primarily geared to roof systems typically found on one- and two-family dwellings:

- Whenever a roof covering is to be replaced, a complete tear-off should be considered and should be completed unless environmental or other issues make removal prohibitive.
- Once the roof covering is removed, the entire roof sheathing should be inspected and all damaged sections of roof sheathing should be replaced. If the sheathing thickness does not conform to current codes and standards, the sheathing should be replaced and proper fasteners should be installed. Roof-sheathing fasteners in the high-wind pressure zones along roof edges and corners should be given particular attention.
- Portions of the roof sheathing may also be removed to provide access to the connections between the roof framing and the walls below. Connections needed to comply with current codes for new construction should be installed.
- A secondary roof barrier should be installed for enhanced water-intrusion protection. When installing a roof underlayment as a secondary barrier, it is important to remember that there are multiple successful methods of installation. FEMA 499 provides guidance on selecting and installing secondary roof barriers.
- When re-roofing, choose a roof covering appropriate for the basic wind speed within the area. Select a roof covering rated for a higher wind speed, if budget allows.

Recent legislative rules issued by the State of Florida promote roofing mitigation through Rule 9B-3.0475. While this rule applies only to residential structures and has restrictions per monetary values, it promotes efforts to strengthen the connections of residential buildings and other mitigation efforts during re-roofing. After connections have been strengthened to meet or exceed the latest effective code, the removed sheathing should be properly reinstalled according to the code. It is paramount to ensure that buildings which may experience high-wind events have the roof decking properly secured to the framing.

Exterior Cladding Components and Best Practices

9.1 Introduction

Chapter 7 presented information on the building structure—specifically roof decking and wall systems. Chapter 8 presented information on roofing materials and coverings. This chapter discusses exterior wall coverings, also known as *cladding*. As in previous chapters, the information herein will present specific building code requirements first, followed by guidance (or industry best practices) for various cladding materials. When possible, a discussion will be included on how these systems may prove resistant to those natural hazards that are prevalent in coastal environments. The discussion of the building envelope will conclude in Chapter 10 with the presentation of design criteria and best practices related to doors and windows.

The building envelope includes: cladding, roof coverings, glazing, exterior walls, door assemblies, window assemblies, skylight assemblies, and other components enclosing the building. In coastal areas, the floors of buildings elevated on open foundations may also be considered part of the envelope. Unlike construction that occurs within inland areas, coastal construction must be designed and built to withstand high-wind events (which can trigger windborne debris), flood events (possibly including wave effects), and other issues, such as the corrosion of fasteners and connectors.

The building envelope can be one of the weakest and most susceptible components of a building. Far more common than structural failures, envelope failures often lead to water intrusion and progressive envelope failures over a larger part of the building. Envelope failures—typically involving a failed component that is itself small in magnitude—may result in disproportionately greater building damage (and associated repair costs) than that caused by the initial breach in the envelope.

The durability of the structure's envelope is dependent upon the type of materials used, the design, and the method of installation. Building envelope components have also been observed to be the predominant source of windborne missiles, as generated from damaged buildings. Close design attention should be given to buildings within special wind regions and within areas where the basic wind speed exceeds 90 mph (in 3-second gusts). Technical guidance for improving the performance of building envelope elements and systems within coastal areas can be found in FEMA 55 and in MAT and BPAT reports. FEMA 499 Technical Fact Sheets also provide specific information on exterior cladding material, installation, and general best-practice guidance for coastal areas.

9.2 Exterior Wall Coverings and Claddings

High winds and flooding are natural hazards that can cause severe damage to exterior wall systems. Seismic events can also damage heavy wall systems or coverings such as brick veneer. Large hail has been reported to damage walls, although widespread damage is uncommon.

A variety of systems can be used for exterior wall construction or cladding. The following wall coverings are commonly used over wood-frame and masonry construction: aluminum siding, cement-fiber panels or siding, exterior insulating finishing system (EIFS), stucco, vinyl, sawn-wood siding, and wood-panel siding. Each of these wall coverings can exhibit varying performance characteristics, including those related to permeability. While material such as vinyl is non-permeable, when used as a siding material it is designed to resist but not prevent water intrusion. Concrete and masonry walls function differently than framed and surfaced walls. While framed walls are designed to shed water; when not surfaced with cladding materials, concrete and masonry construction is designed to absorb water and release it through evaporation. FEMA 499, Technical Fact Sheet No. 8: *Coastal Building Materials* contains additional information on coastal building materials and best practices for selecting and using different materials.

NOTE

ASCE 7-05, Section 6.1.4.2, on components and cladding (C&C), requires that the minimum design pressure for C&C shall be +/- 10 psf regardless of the basic wind speed at a site.

After recent hurricanes, MAT reports have documented that wall coverings ripped from houses can become windborne debris, easily capable of damaging other structures. These reports also show that pressurization and damage to the interior contents of buildings is often the result of a progressive failure of the exterior wall covering. High winds are the most common cause of these initial failures. While compliance with current codes and standards will make buildings much less vulnerable to water entry and damage from debris impacts, some actions (considered code plus or best practices) have been shown to improve building-envelope performance. Those construction practices exceed code minimums and their use is often warranted when trying to achieve improved protection within a coastal environment.

9.2.1 Designing for Wind Forces

Exterior walls must be designed and built to withstand code-specified basic (design) wind speeds; this includes both MWFRS and C&C loads. Basic wind speeds can be found using wind maps from various codes and standards (ASCE-7-05 contains a wind map used by the IBC, IRC, and most contemporary construction standards). In coastal areas, wind speeds are generally greater, so the effects of high winds on exterior cladding are a primary concern in coastal construction.

NOTE

Another solution still being developed involves air-permeable wall coverings. The discussion of air-permeable roof coverings presented in Chapter 8 also applies to air-permeable wall coverings, such as siding. Research on special-pressure coefficients for air-permeable wall claddings need to be conducted before new code requirements can be developed.

Wind design of exterior wall coverings on residential structures can be performed using prescriptive or performance-based codes. The prescriptive solutions in both the IBC and the IRC concern areas where the basic wind speed is less than 110 mph (or less than 100 mph in hurricane-prone regions). In areas where the basic wind speed is 110 mph or greater (or 100 mph or greater in hurricane-prone regions), the prescriptive solutions of the IBC and IRC do not apply. For those areas, Section R301.2.1 references high-wind standards such as AF&PA's WFCM, the ICC-600, and the *AISI Standard for Cold-Formed Steel Framing: Prescriptive Method for One- and Two-Family Dwellings*. As an alternative to prescriptive designs (and as required for buildings that fall outside of the range of prescriptive solutions), buildings can be engineered to meet the requirements of the IBC, which requires that building components resist loads in accordance with ASCE 7-05.

Many jurisdictions are still using the SSTD 10 and following its prescriptive guidance for the main wind force resisting system (MWFRS) of the building envelope. Although this is a very helpful standard, this detail for C&C design is limited. The ICC-600 provides more detailed guidance on the building envelope and addresses both the MWFRS and the C&C.

IBC Requirements

Wall-covering requirements are covered primarily in Chapter 14 of the IBC. Various requirements are contained in Section 1405.1 (general), Section 1405.2 (weather protection), and Section 1405.3 (flashing). Requirements for specific wall-covering systems are contained in subsequent sections: Section 1405.5 (wood veneers), Sections 1405.5 and 1405.9 (anchored and adhered masonry), Section 1405.6 (stone veneers), Section 1405.7 (slab-type veneers), Section 1405.8 (terra cotta veneers), and Section 1405.10 (metal veneers). Some of the more common exterior cladding materials include vinyl siding (Section 1405.13) and fiber-cement siding (Section 1405.17).

Each section includes requirements that are unique to that style of cladding. For example, heavier cladding materials (such as masonry or stone) have additional seismic requirements identified. Lighter materials, such as vinyl siding, may have additional requirements concerning backing material and fastening.

IRC Requirements

Like the IBC, the IRC contains general requirements for all exterior systems, as well as more specific requirements for individual wall covering systems, which are contained in other sections. Section R703.1 contains general requirements for all systems. These general requirements include: providing the building with a weather-resistant envelope, providing flashing (with some exceptions), preventing the accumulation of water within the wall, and protections from condensation. Water-resistive barriers requirements are contained in Section R703.2 and general requirements for wall system attachments are outlined in Section R703.4.

Exceptions exist for Section R703.1 requirements that pertain to concrete and masonry construction (that are less vulnerable to water damage) and tested systems that provide the same performance as the systems prescribed in Section R703 without using the specific components required in Section R703.1.

Subsequent sections address specific exterior coverings: Section R703.3 (wood, hardboard, and wood structural panel siding), Section R703.5 (wood shakes and shingles), Section R703.6 (plaster or stucco), Section R703.7 (stone and masonry veneer), Section R703.9 (Exterior Insulation Finishing System, or EIFS), Sections R703.9.1 and R703.9.2 (specific EIFS requirements for water-resistive barrier and flashing), Section R703.10 (fiber-cement siding), and Section R703.11 (vinyl siding).

Moisture Barriers

The IBC and IRC recognize three methods of weather protection for walls: 1) walls can be constructed with flashing and water-resistant barriers (WRB) (see Figures 9-1 and 9-2), 2) walls can be constructed with an exterior wall system which has been certified to resist wind-driven rain, or 3) walls can be constructed with concrete or masonry.

The first method (which is often used with wood siding, cementitious stucco, and brick veneer) functions to prevent water from entering the cladding and provides drainage paths for water that does enter. The second method (which includes many EIFS, curtain walls, and other specialized systems) strives to prevent water from entering the cladding and may or may not have drainage provisions to address water that does enter. The third method utilizes weather protection (using concrete or masonry walls), which allows water to be absorbed by the building and then be released to the exterior or interior through evaporation.

The first two methods are referred to as barrier methods, with the first method serving as a traditional barrier method. The general requirements set forth by the IBC (Section 1403.2) and IRC (Section R703.1) state that a building must have a weather-resistant exterior wall envelope (unless that building is constructed with a concrete or masonry wall system that meets IBC and IRC requirements). Alternatively, the wall envelope must be demonstrated to resist wind-driven rain through testing of the envelope (including joints, penetrations, and intersections constructed of dissimilar materials) in accordance with ASTM E 331 and in accordance with the conditions listed in the sections of the standards. For protection over studs or sheathing, the IBC requires a minimum of one layer of No. 15 asphalt felt, complying with ASTM D 226 for Type 1 felt or other approved materials, shall be attached to the studs or sheathing. The IRC states the same stipulations, but goes further to say that such felt or material shall be applied horizontally, with the upper layer lapped 2 inches over the lower layer and 6 inches at vertical end joints.

Traditional barrier systems function best when an air space exists between the exterior cladding and the WRB. Thin furring strips can be installed between lapped siding and the WRB to create this air space. Systems that incorporate a drainage gap into the WRB are also available. When brick veneer is used, mortar should not fill the air gap between the veneer and the WRB, even though doing so is allowed by code.



Figure 9-1 and 9-2.
Examples of moisture barrier systems. (Source: FEMA 549)

In areas where the duration of severe or wind-driven rains is brief, the weather-protection methods allowed by the IBC and IRC should perform satisfactorily. In coastal areas, however, rains can be prolonged, severe, and frequently driven by high winds. Prolonged wind-driven rains can overwhelm the water-storage capacity of mass systems (i.e., concrete or masonry structures) and driving winds can create pressures that exceed those of tested systems. The use of traditional barrier systems with flashings and drainage paths should be considered within coastal areas. Tested systems are appropriate to use if they have been certified for wind speeds and rain conditions present within coastal environments. Mass systems will function best when multiple layers of moisture protection are implemented. For example, if the building skin utilizes concrete or masonry, the building will withstand the significant wind forces of a hurricane, but will likely be oversaturated by the sustained heavy rains that also accompany hurricanes. This will cause water damage and associated problems in the building (e.g., mold). To effectively control water intrusion, the layers of moisture control should be increased by adding siding over the concrete or masonry walls and designing proper drainage paths between the two materials.

If siding is used, proper lapping must be ensured to maximize moisture control (see Figure 9-3). Capillary action causes water to travel in all directions and allows water to infiltrate siding if lapping is installed incorrectly. It is important that siding is spaced with enough lap distance to limit water intrusion. Manufacturer specifications should always be followed during installation; for improved performance, consult with a design professional for a longer lap distance. More information can be found on FEMA 499, Technical Fact Sheet No. 9: *Moisture Barrier Systems*.

The use of a secondary layer of protection against wind-driven water infiltration (e.g., an air-barrier film) is recommended underneath wall coverings. Designers should specify that horizontal laps be installed so that water is allowed to drain from the wall (i.e., the top sheet should lap over the bottom sheet in order to allow water running down the sheets to remain on their outer face). The bottom of the secondary protection needs to be detailed to allow drainage.

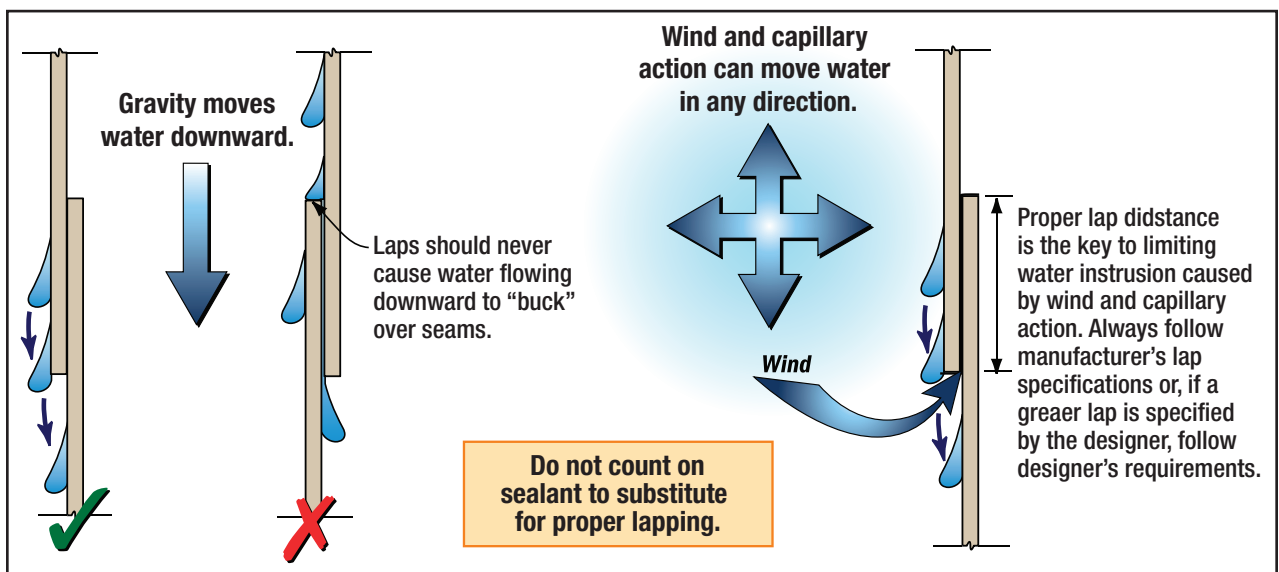

Figure 9-3. Proper siding lapping to prevent moisture penetration. (Source: FEMA 499)

9.2.2 Flashings

Flashing is required by the IBC (Section 1405.3) and IRC (Section R703.8) in order to prevent moisture from entering the wall system or to redirect it to the exterior. Flashing is typically located at exterior door and window assemblies and at any penetrations, projections, or terminations in the exterior of the building. The poor performance of flashing, resulting in the loss of water-intrusion protection, is a common problem in many coastal homes. In areas that frequently experience strong winds, enhanced flashing details are recommended to provide better protection against wind-driven rain. Enhancements include flashings that have extra-long flanges, and the use of sealant and tapes. General guidance is offered herein, but it is recommended that designers also attempt to determine what type of flashing details have successfully been used within the area where the residence will be constructed.

Flashing design should recognize that wind-driven water can be pushed vertically. The height to which water can be pushed increases with wind speed. Water can also migrate vertically and horizontally by capillary action between layers of materials (e.g., between a flashing flange and house wrap).

9.3 Exterior Covering and Best Practices

While the exteriors of homes constructed to current building codes generally perform well in coastal environments, actions that go beyond code-minimums often improve building performance. Code-plus or best-practices approaches for common exterior-covering materials are presented in the following sections. With the evolution of modern building codes, approaches that have consistently resulted in good performance have been incorporated into codes and are now required.

Flashing guidance specific to roof/wall connections, windows, and doors is provided here. For more information, see FEMA 499, Technical Fact Sheets No. 22: *Window and Door Installation* and No. 24: *Roof-to-Wall and Deck-to-Wall Flashing*.

Roof/wall flashing. Specifically, roof and roof-to-wall flashing is addressed in Section 1503.2 of the IBC and Section R903.2 of the IRC. Figure 9-4 illustrates a good roof/wall flashing detail that is code-compliant and includes best practices recommended in this section. It recommends that where enhanced protection is desired above the code minimums, use step flashing that has a vertical leg that is 2 to 4 inches longer than normal. (This detail has been used successfully by a builder on the Delaware coast.)

Alternatively another recommendation (or for a more conservative design, in addition to the long leg), suggests taping the top of the vertical flashing to the wall sheathing with 4-inch-wide self-adhering modified bitumen roof tape. (Apply about 1 inch of tape on the metal flashing, and 3 inches on the sheathing.)

It is also considered good practice to extend the house wrap over the flashing in the normal fashion. It is important not to seal the house wrap to the flashing; if water reaches the house wrap higher up the wall, that moisture needs to be able to drain out at the bottom of the wall.

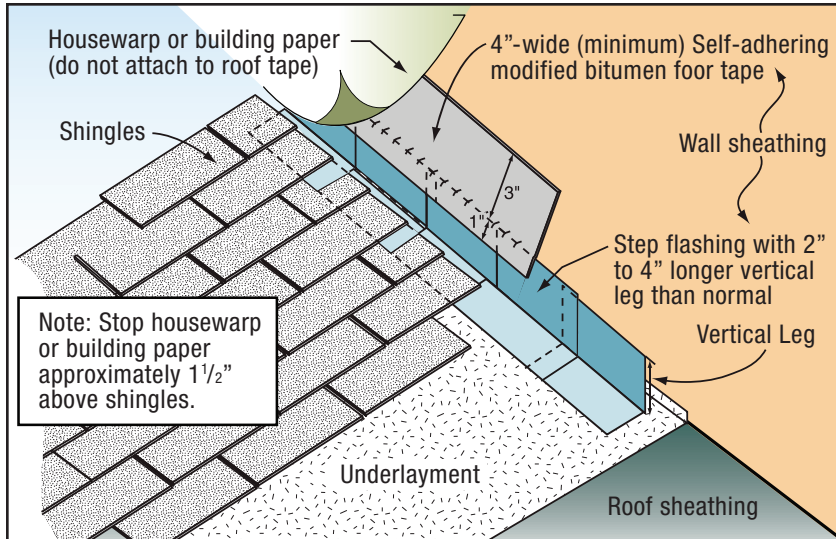

Figure 9-4.
Roof flashing. (Source: FEMA 499)

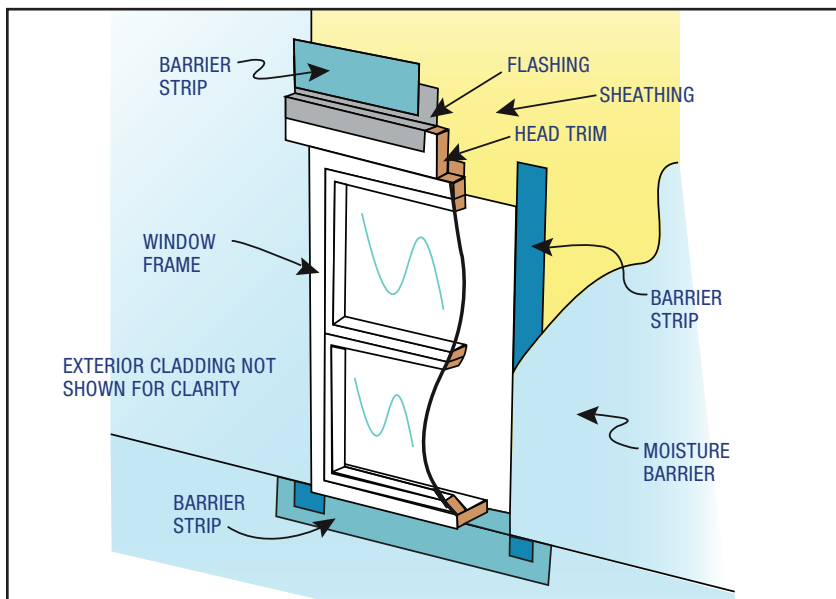

Figure 9-5.
Window flashing details.

Window/Door Flashings. For windows with nailing flanges, it is considered good practice to apply a generous bead of butyl sealant to the wall sheathing before setting the window. Then place the sealant inward of the fasteners. At sheathing joints, place sealant over the joint, from the window opening out past the flange. Place the housewrap over the head-trim flashing, and tape the flange to the housewrap with duct tape or modified bitumen roof tape. A recommended flashing detail is shown in Figure 9-5.

Conceptually, the exterior siding should not be thought of as the only barrier to water intrusion. The housewrap (typically required under most sidings), flashings, and underlayment must be used to shed and direct water away from openings in the building envelope. The overriding principle of successful water diversion is to install the layers of building materials correctly so that water cannot get behind any one layer and into an opening.

Vinyl Siding. Vinyl siding can successfully protect homes and function adequately within a coastal environment, if properly installed. Designers and builders should choose siding that is rated for high winds. These products typically have an enhanced nailing hem and are sometimes made from thicker vinyl. Figures 9-6, 9-7, and 9-8 provide details and illustrate proper installation techniques for vinyl siding. Thick, rigid panels provide greater wind resistance, withstand dents, and lie flatter and straighter against the wall. Panels that have performed well possess an optimum thickness ranging from 0.040 inch to 0.048 inch, depending upon the style and design. Also, many vinyl-siding systems must be installed over solid sheathing to perform at their rated wind speed without damage or failure. Manufacturers' installation instructions should contain this information and other requirements. More information can be found in FEMA 499, Technical Fact Sheet No. 25: *Siding Installation and Connectors*.

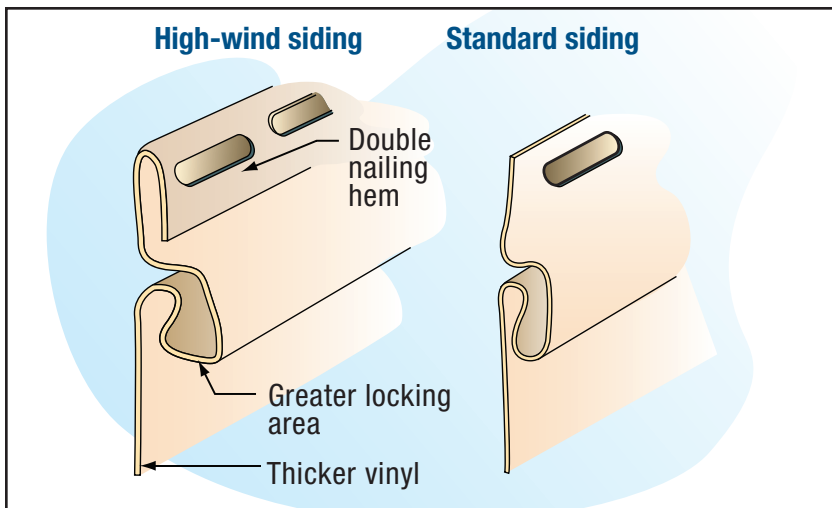

Figure 9-6. Comparison of typical high-wind siding versus standard siding. (Source: FEMA 499)

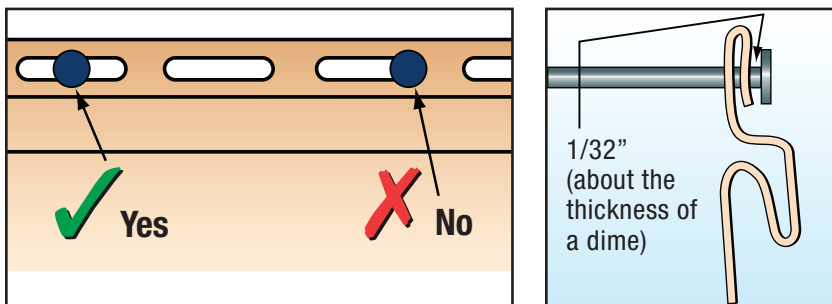

Figure 9-7. The center of the nailing slot is the proper fastener location. (Source: FEMA 499)

Figure 9-8. Proper fastener clearance. (Source: FEMA 499)

After Hurricane Katrina, the FEMA MAT Report (FEMA 549) concluded that, while much of the vinyl siding damage from the storm was due to application deficiencies (i.e., excessive spacing of fasteners), the siding observed was rated only for 90 mph basic wind speeds (at 3-second gusts) yet it was installed in an area without code-specific basic wind speeds of 110 to 120 mph. Findings reported in the Hurricane Charley MAT (FEMA 488) Report also show that vinyl siding frequently tears around the fasteners during high-wind events. Some general recommendations to improve the performance of vinyl siding within coastal areas include:

- Drive nails straight and level to prevent distortion and buckling in the panel.
- Do not caulk the panels where they meet the receiver of inside corners, outside corners, or J-trim. Do not caulk the overlap joints.

- Do not face-nail or staple through siding.
- Use aluminum, galvanized steel, or other corrosion-resistant nails when installing vinyl siding. Aluminum trim pieces require aluminum or stainless steel fasteners.
- Nail heads should be no less than $\frac{5}{16}$ of an inch in diameter. Shank should be $\frac{1}{8}$ inch in diameter. (Source: FEMA 499)

Wood Siding. Many requirements for wood siding materials are cited in Chapter 23 of the IBC, but the detailed design and fastening of wood siding needs to be calculated according to the C&C loads described in ASCE 7. The IRC gives C&C loads in Table R301.2(2) that are applicable to designing and selecting wood-siding systems for wind speeds up to 110 mph. Section R603.7 provides prescriptive guidelines for areas in which the basic wind speed is less than 110 mph. To meet the design requirements when the wind speed exceeds 110 mph (for these code sections), a designer must determine wind loads per the IBC or other publications referenced in Chapter 3 of this guide. Figure 9-9 shows an example of each layer of material applied to the exterior of a wood-framed house using wood siding. Some general recommendations to improve the performance of wood siding within coastal areas include:

- Use naturally decay-resistant wood such as redwood, cedar, or cypress.
- Back-prime wood siding before installation.
- Carefully follow the manufacturer's detailing instructions to prevent excessive water intrusion.
- Use high-quality stainless-steel nails to prevent siding damage (i.e., staining).

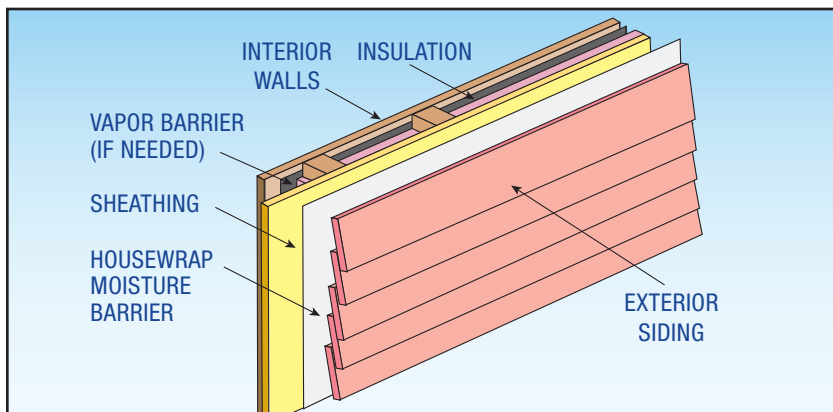

Figure 9-9.
Example of wood siding on
a wood-framed house.

Brick Veneer. The current masonry code referenced in the IBC and IRC is ACI 530-08/ASCE 5-08/TMS 402-08, 2008 Building Code Requirements for Masonry Structures. This code provides both prescriptive and performance-based requirements. Brick-veneer construction in residential applications tends to follow prescriptive requirements. Brick veneer is addressed by the IRC with prescriptive minimum requirements for sizing and spacing of masonry ties. In high-wind areas (where more than 30 pounds per square foot of pressure is applied to the brick), each tie is not permitted to support more than 2 square feet of wall area. The ICC-600 provides design requirements that vary with design wind speed. At greater speeds, ties are required to be designated as a percentage

of the tributary area that would be used at lower wind speeds. Figures 9-10 and 9-11 illustrate how brick veneers failed during Hurricane Katrina, due to improper design and construction of the wall covering.

Appendix E of FEMA Hurricane Katrina Recovery Advisory (*Attachment of Brick Veneer in High-Wind Regions*) provides recommended practices for brick-veneer attachment. This advisory was based upon observations from hurricanes Ivan and Katrina.

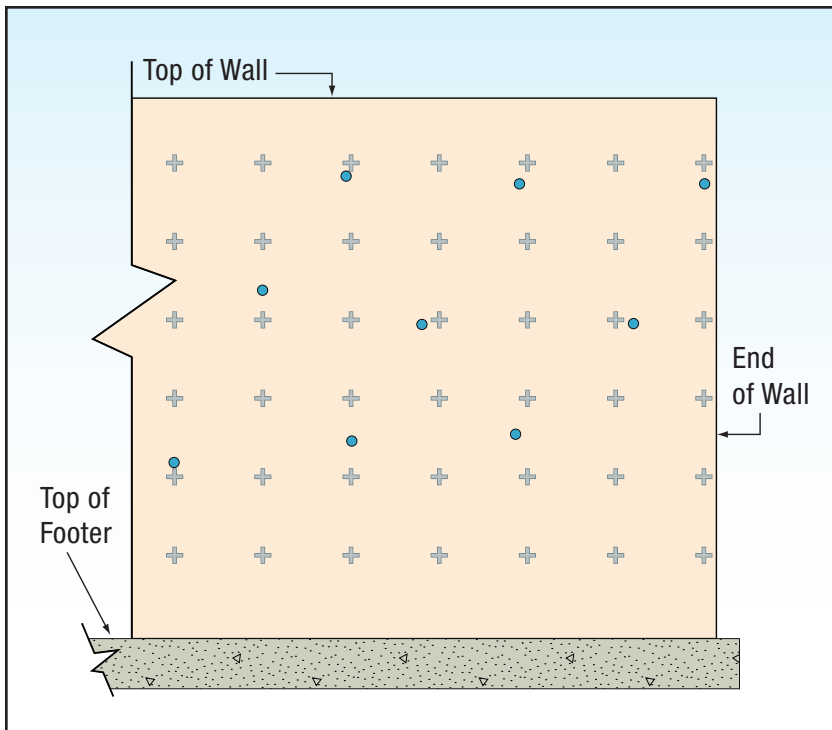

Figure 9-10.
This figure illustrates the layout of brick ties at house under construction in Ocean Springs, Mississippi, observed after Hurricane Katrina. At this wall, nine ties were installed (blue circles); however, 42 ties (“+” symbol) are needed to comply with the advisory. (Source: FEMA 549)



Figure 9-11.
WAVELAND, MISSISSIPPI: House with collapsed brick veneer as a result of insufficient wall ties. (Source: FEMA 549)

Exterior Insulation and Finish System (EIFS). This exterior wall covering system has been assessed in detail in FEMA MAT reports and the official should consult FEMA 488, 489, and 549 for information related to the performance of these systems following storm events. In addition, the official should consult the manufacturer's product information before making a final determination on the suitability of the system for the requested application.

9.4 Exterior Floor Coverings

Residential buildings located near the ocean are almost always elevated. In such a structure, the space underneath the building is exposed to the elements unless it has been enclosed with sheathing or another weather-resistant covering. Applying sheathing to the underside of the bottom-floor joists or trusses helps minimize corrosion of framing connectors and fasteners by limiting exposure to salt spray and other environmental factors. The sheathing also protects insulation installed between the joists/trusses from the effects of wave spray. (If fiberglass insulation is installed, the paper or foil face should be installed adjacent to the underside of the floor decking. Barring this, the insulation should be faced correctly if a moisture trap is used, so that downward water-vapor migration is not impeded. For long-term durability, exterior-grade sheathing is recommended for the exposed sheathing and it should be fastened with stainless-steel or hot-dipped galvanized nails or screws.)

Suction forces induced by high winds will cause floor systems to be pulled downward. Installing rated roof sheathing at under-floor applications and securing it to the floor framing using the same nailing schedule as that required for roof sheathing will adequately secure the under-floor sheathing. To prevent moisture from being trapped, the floor-joist cavity created by the under-floor sheathing should be vented. Figure 9-12 shows how the exterior floor covering (which was damaged during the event itself) prevented decay of the floor system and may have contributed to the survival of the building.



Figure 9-12. Example of an exterior floor covering system damaged by Hurricane Ivan. Note the good condition of the floor joists and flooring, due to their protection from salt spray prior to the storm. (Source: FEMA 489)

9.5 Soffits

Vinyl (along with aluminum) is also a commonly used material for soffits in residential buildings. However, aluminum and vinyl soffits are very prone to failure when exposed to high winds. If the soffits of a home fail, wind-driven rain can enter the ceiling and areas above the top of the wall and cause extensive water damage. Also, loss of soffits can increase internal pressures and lead to loss of the roof sheathing and, ultimately, to building failure.

To perform adequately, these building elements must be able to resist suction (i.e., downward) pressure and positive (upward) pressure. The general requirements (that include wind loads) contained in Section 1609.1 of the IBC and in Section R301.1 of the IRC mandate that all portions of buildings (this includes soffits) resist design-wind pressures. However, neither the IRC nor the IBC include prescriptive designs for soffits and very little industry guidance or information about best practices exists. In the IRC, most of the attention given to soffits focuses on fire resistance. Section R703.11.1 requires that vinyl siding, soffit and accessories shall be installed in accordance with the manufacturer's installation instructions.

Recent assessments of high-wind events—most notably FEMA 488 (in Florida) and FEMA 549 (in the Gulf Coast)—report widespread failures in building soffits. The lack of prescriptive designs for vinyl soffits has likely contributed to these widespread failures. The MAT reports recommend that research be performed so that prescriptive requirements may be developed and proposed for adoption in the I-codes.

9.6 Concrete and Masonry Walls

Concrete and masonry walls are valued in coastal construction for their ability to resist high wind loads and windborne debris when properly grouted and reinforced. However, with respect to drainage, the material properties of both concrete and masonry allow them to absorb water into their mass for evaporation later. When exposed to long, sustained periods of rain, the water-storage capacities of concrete and masonry assemblies may be overwhelmed, forcing excess water to the interior of the building. Thus, the moisture-collecting properties of these wall systems may not yield positive results. While both the IBC (Section 1403.2) and IRC (Section R703.1) allow concrete and masonry walls to be installed without water-resistive barriers, it is recommended that a properly installed exterior cladding system with a water-resistive barrier be installed to provide excellent overall protection within coastal areas.

NOTE

Durability: To avoid corrosion problems, stainless steel or hot-dipped galvanized fasteners (preferably heavy-duty, hot-dipped galvanized fasteners) are recommended for buildings located within 3,000 feet of an ocean shoreline. If air can freely circulate in a cavity (i.e., above a soffit), access panels should be provided so components within the cavity can be periodically observed for corrosion. In areas with severe termite problems, if the use of wood is specified, it should be pressure-treated.

Siding, panels (e.g., textured plywood), and stucco over masonry and concrete typically perform well during high winds. The key to the successful performance of a siding and panel system is proper attachment, involving a sufficient number of proper corrosion-resistant fasteners (based upon design loads and tested resistance) that are correctly located. The dislodging of stucco applied directly to concrete walls has occurred in areas where wire mesh was not applied over concrete.

Where required by code, concrete and masonry walls (and veneers) need to be designed for the seismic load. When the use of a heavy covering (such as stucco, cement-fiber panels or siding, or brick veneer) is specified, the seismic design should account for the added weight of the material, and its connection to the base material (in the case of veneer). Inadequate connection of veneer material to the base substrate has been a problem during past earthquakes and can result in a life-safety hazard. Some non-ductile coverings (e.g., stucco and cement-fiber products) may become cracked during seismic events. If the use of these coverings is specified in areas prone to large ground-motion accelerations, the structural sheathing behind the covering should be designed with additional stiffness to minimize damage to the wall covering.

Fiber-cement siding is a product used in applications similar to wood siding materials. Following flood events, it was noted to be an effective exterior siding within those areas exposed to sustained floodwaters. Careful consideration should be given to the installation procedures required for these products and the manufacturer's recommendations should be consulted for proper application. Anecdotal evidence following Hurricane Katrina noted that for wood-framed buildings it was important that the siding be attached to the building at the stud locations and that this distance should not exceed 24 inches. The siding should not have fasteners within 1 inch of the top of the siding. The manufacturer should be consulted on whether concealed fasteners are appropriate based upon the building's required design wind speed.

For buildings in areas prone to wildfires, the greatest protection is offered by concrete, masonry, stucco, or cement-fiber panels or siding. Sheathing the underside of joists or trusses with a fire-resistant material (such as cement-fiber panels) is recommended. Cement-fiber panels should be attached with stainless steel or hot-dipped galvanized screws. If a wall surface is specified, a fire-resistive system should also be specified for soffits (e.g., stucco or cement-fiber). Gable and soffit vents should have openings covered with wire mesh that itself has openings no greater than 1/4 inch, in order to inhibit the entry of burning brands. For added protection, non-combustible hinged shutters that can quickly be placed in the closed position could be designed and installed.

NOTE

Additional guidance on seismic-resistant residential construction can be found in FEMA 232, *Homebuilders' Guide to Earthquake Resistant Design and Construction*. This guide provides supplemental information on the 2003 IRC and also includes "above-code recommendations" and low-cost measures to improve building performance.

Windows, Doors, and Opening Protection

10.1 Introduction

Windows, skylights, vents, and glazed portions of doors are critical components of a building's envelope. Codes and standards use the term *glazing* to address all windows and openings containing glass. Specifically, ASCE 7-05 (which is incorporated by reference into both the IBC and IRC) provides the following definition for glazing:

GLAZING: Glass or transparent or translucent plastic sheet used in windows, doors, skylights, or curtain walls.

Glazing systems simultaneously allow natural light to enter the building's interior and provide a scenic view of the coast. However, these systems are very vulnerable to damage from wind forces and windborne debris unless specifically designed to resist such forces and impacts. Recent MAT investigations and laboratory tests have shown windows and doors are also susceptible to wind-driven rain penetration. Special consideration should be given to these features of the building envelope. In all areas where buildings are constructed, windows and doors tend to be more vulnerable to damage than other portions of a building's envelope. In coastal areas—where high winds, windborne debris, and wind-driven rain are common and often intense—their vulnerabilities are more pronounced.

This chapter presents actions needed to ensure that windows and doors can resist the hazards common to coastal areas. This chapter describes typical failures in windows and doors, discusses requirements contained in national codes and standards, outlines the nuances of window- and door-testing and certification, and discusses some best-practices approaches to installing and protecting windows and doors. The chapter finishes with a discussion of garage doors.

10.2 Window and Door Failure

In coastal environments, numerous post-disaster investigations conducted by FEMA have shown that windows and glazed portions of doors are vulnerable to impact from windborne debris. This impact force is the principal failure mode for these systems. Debris from the natural environment (e.g., tree limbs) and from the built environment (e.g., roofing material, siding material, sawn lumber, etc.) can become windborne debris and break window and door glazing. Once broken, windows and glazed portions of doors can allow wind, windborne debris, and rain into the interior of the building. This can result in the following:

- Large amounts of water may enter a building and damage its contents and finishes. There is also the possibility that the water could compromise certain structural members. If water intrusion occurs, action will not only be needed to eliminate the water-induced damages on appurtenances (such as carpets, cabinets, and floors), but also to mitigate all potential long-term moisture problems associated with certain construction materials.

- Wind forces or pressures inside a building are dramatically increased when the building's envelope is breached. It is not uncommon to observe significant damage to structural and nonstructural building elements from this internal pressurization. Such damage may remain isolated to a small area or room or it may result in damage severe enough to initiate the complete structural failure of the building.

Water leakage around windows and doors is also quite common but because the effects of leakage are often subtle, the full effects of leakage are often not readily apparent. Leakage from poor flashing or weather stripping, from improper installation, or from doors or windows being inadequate to resist local conditions can allow water to enter a building's interior—even when the structure of the window or door remains intact. Water intrusion can cause rot and fastener corrosion that weaken the window or door frame or the wall framing itself. Leakage can also cause damage to interior finishes and facilitate mold growth.

Wind-pressure failure of glazing is also occasionally observed. Windows and doors can fail if they are not strong enough to resist wind pressures from a high-wind event or if forces exerted on the doors or windows exceed the strength of their anchorage. Figure 10-1 shows how the failure of a large window led to the loss of the roof structure. When strength is inadequate, the window or door's glazing or frames fail; when anchorage is inadequate, the entire door or window unit can be torn from its mounting. Negative pressure (i.e., suction) failures are more common but positive pressure failures can occur as well. Figure 10-2 shows a window separated from its frame due to positive pressures acting inward on a window system.



Figure 10-1.
PUNTA GORDA, FLORIDA:
Failure of a roof structure from
pressurization of a house when the
window failed on the windward face.
(Source: FEMA 488)

New and older buildings may have windows broken by debris if windows are not protected. Figure 10-3 shows a window on a home under construction that was broken by windborne debris, while Figure 10-4 shows an oceanfront home that experienced window breakage when unprotected glazing was impacted by windborne debris. Properly addressing these failures requires doors and windows to be: 1) correctly designed and anchored to resist wind pressures, 2) adequately protected to resist windborne debris, 3) sufficiently flashed and weather-stripped to limit water infiltration, and 4) appropriately selected to resist local conditions.

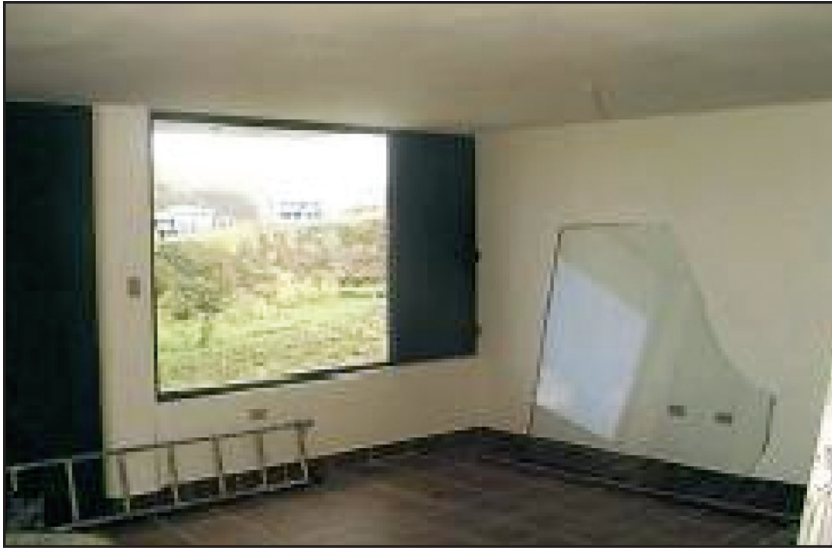

Figure 10-2.
PUERTO RICO, 1998:
Failure due to inadequate pressure rating of window. The window frame remained attached to the wall but the glazed portion was blown inward by positive pressures.
(Source: FEMA 55)



Figure 10-3.
PUNTA GORDA, FLORIDA:
Glazing failure due to windborne debris from displaced roofing.
(Source: FEMA 488)



Figure 10-4.
Glazing failure due to windborne debris. An oceanfront home damaged during Hurricane Ivan due to windows being broken by windborne debris.
(Source: FEMA 489)

10.3 Windborne Debris Protection Systems

Damage to glazing systems can be prevented, or at least minimized, by using glazing or opening protection systems that have been designed to resist wind and windborne debris forces specified in the building code. Impact-resistant (i.e., debris-resistant) systems provide protection through the use of laminated glass or polycarbonate glazing systems. The use of physical-opening protection systems such as shutters, screens, or structural wood panels (as allowed by the IBC and IRC in certain hazard areas) is also a common means of achieving protection for glazing.

By far, the most effective solution is impact-resistant glazing systems. These systems provide in-situ protection and require no human action or involvement after installation; the protection system is in place at all times and does not need to be installed prior to storm events. Further, these systems do not need to be closed, lowered, or installed like storm panels or shutter systems. While impact-resistant glazing systems are one of the more expensive options for debris protection, their use may be determined to be appropriate for high-end homes (where the relative cost of laminated systems as compared to the total building cost can be low) and for buildings used for vacation homes (which are not continuously occupied). Their application may also be appropriate on the upper levels of homes or buildings, where the installation of shutters may prove difficult.

Shutters, screens, and panel systems are the next-most-desirable option after impact-resistant systems. These systems protect vulnerable glazing from windborne debris but only when installed in place before the event strikes. Some styles of shutters (e.g., roll-up or accordion-style) are made to be deployed or positioned to protect glazing with little effort; many have electric-powered motors that facilitate their operation. Of course, electrically operated shutters need power to run and occasionally power is lost early during a storm. Other styles, often called storm panels, are designed to be easily removed and kept in storage and installed only when a storm is approaching. If in place during a high-wind event, properly tested and certified shutters, screens, and storm panels are as effective as laminated, in-situ systems. However, installing these panels requires more effort and planning by home and property owners.

Wood structural panels (which include plywood and OSB) are allowed by the IBC and IRC in certain applications. Often these panels are large, single panels that are unwieldy and difficult to install particularly when winds begin to build and the panels need to be installed in order to protect upper-floor windows, glazing, or skylights. It is also difficult to prevent a homeowner from using wood structural panels if these custom wood panels meet the deflection requirements for which they are used. Wood structural panels, however, are relatively inexpensive and may be the most appropriate method for low-cost housing.

10.3.1 Impact-resistant Glazing Systems

Laminated glazing systems typically consist of assemblies fabricated with two (or more) panes of glass and an interlayer of a polyvinyl butyral (or equivalent) film laminated into a glazing assembly. Laminated systems are non-porous and have slightly different pass/fail criteria in ASTM E1996. During impact testing, the glass panes in the system can fracture but the interlayer must remain intact to prevent water

NOTE

It is very important to note that shutters, screens, and other panel systems that protect glazing from debris impacts are rarely, if ever, rated to reduce wind pressures on the windows they protect. A system that typically has been rated for a pressure rating has been rated to resist that pressure in order to avoid blow-off or excessive deflection—not to decrease pressure on a window or door that the system protects.

and wind from entering the building. Depending upon the level of protection (i.e., enhanced or basic), tears are allowed in the film used in windows but tears must be less than $\frac{1}{16}$ inch wide and less than 5 inches long and cannot allow a 3-inch-diameter ball to pass through the tear. After impact testing, the laminated glazing systems must resist the cyclic pressure tests of ASTM E1886.

Polycarbonate glazing systems are also used in place of traditional laminated glazing systems. Polycarbonate systems typically consist of plastic resins which are molded into sheets which provide lightweight, clear glazing panels with high impact-resistance qualities. The strength of the polycarbonate sheets is much higher than non-laminated glass (i.e., more than 200 times stronger) or acrylic sheets or panels (more than 30 times stronger). Several brands of polycarbonates used as glazing (such as Lexan and Makrolon) are commonly available. Both impact-resistant windows and shutter systems may be constructed using polycarbonates.

10.3.2 Shutter, Screen, and Panel Systems

Shutters, screens, and non-wood panel systems are separate systems and are tested independently from the glazed portions of the windows and door they protect. While certified shutters protect glazing from debris impact for an identified missile at a prescribed impact speed, most shutter systems are porous and do not significantly reduce wind pressures on the glazing itself. Glazing protected by shutters does not need to be debris-impact-resistant but it does need to be strong enough to resist design wind pressures.

During testing, the shutter system must withstand the impact of the test missile while preventing the missile from penetrating the innermost plane of the test specimen. Also, after successful testing, there can be no openings formed that allow a 3-inch-diameter ball to pass through them.

To be effective, shutters should fully cover the glazing they are meant to protect. In retrofit installations, shutters are occasionally observed that do not cover the entire window or are obstructed by window unit air conditioners or other appliances (see Figure 10-5).

Also, as a best-practices approach, shutters should be anchored to the wall surrounding the window, and not to the window or door frame itself. Shutters should never be anchored to the window frame unless: 1) the window is properly anchored to the wall in a fashion that resists imposed wind pressures, and 2) the shutter is certified to perform properly when attached to the window or door frame. Typical installation of shutters, screens, and panels requires brackets or other mounting devices (such as anchors) to be secured to the walls or other elements that surround the window and not the window or door itself.

Shutters installed on upper floors or in difficult-to-reach areas can be challenging to install or operate. Several motorized styles are available to facilitate the operation and deployment of shutters in difficult-to-reach areas. If motorized shutters are used, the shutter system should also be manually operable. If not, loss of electrical power can render the shutters ineffective prior to an event and might prevent opening after an event.

10.3.3 Wood Structural Panels

Wood structural panels are not required to be tested and certified, but are assumed to offer an acceptable level of protection if installed as prescribed. The IBC and IRC specify minimum panel-thickness requirements along with maximum spans for the wood structural panels. Limiting panel spans places upper limits on the stresses within the panel and controls deflection of the panel. Like shutters, wood structural panels are considered porous and are not certified to reduce wind pressures on the glazing itself. Windows and doors protected by wood structural panels must still meet wind-pressure requirements specified in the code.

10.4 Protection Requirements for Windborne Debris

While the potentially devastating effects of windborne debris have been known for years, windborne debris provisions have only recently been introduced into national codes and standards. The 1995 edition of ASCE 7 first specified the debris-impact protection requirements for glazing from windborne debris. That standard stated that glazing in the lower 60 feet of all buildings located in regions where the basic 3-second gust wind speed equaled or exceeded 110 mph had to be protected against windborne debris or that buildings had to be designed to resist higher internal pressures. The standard allowed buildings in these high-wind areas to have unprotected glazing but required that the structure be designed to resist higher wind pressures (from internal pressurization). This approach, while valid from a structural standpoint, allowed building contents and furnishings to be damaged by water entry from broken glazing. Further, this approach left the building envelope unprotected against known hazards. Loss of windows due to windborne debris may result in damage that is many times the replacement cost of the building. This is due to what is often extensive damage to building contents and the loss of operations of the damaged building. These costs were comparable to a full-building loss, although the structure had not failed.

Since 1995, the performance requirements for windborne debris protection have increased while the locations where windborne debris provisions are required have been lessened slightly. Currently, the IBC and IRC no longer allow designers to have the option of designing buildings for higher internal pressures with unprotected glazing in windborne debris regions; the glazing must be protected. This ensures that new buildings not only can resist wind pressures but also can provide protection against windborne debris and minimize impact to homes and businesses, thereby reducing insurance claims caused by water entering broken glazing.

The IRC, IBC, and ASCE 7-05 currently define windborne debris regions as follows:

Windborne Debris Region: *Portions of hurricane-prone regions that are within 1 mile of the coastal mean high-water line where the basic wind speed is 110 mph (49 m/s) or greater; or portions of the hurricane-prone region where the basic wind speed is equal to or greater than 120 mph (54 m/s); or Hawaii.*

and where hurricane-prone regions are defined as:

Hurricane-prone Regions: *Areas vulnerable to hurricanes, defined as:*

1. *The U.S. Atlantic Ocean and Gulf of Mexico coasts where the basic wind speed is 90 mph (40 m/s), and*
2. *Hawaii, Puerto Rico, Guam, Virgin Islands, and American Samoa.*

As defined, windborne debris regions in the continental United States extend along the Gulf of Mexico from Texas to the southern tip of Florida, and along the Atlantic Coast from the southern tip of Florida to Massachusetts. This also includes Hawaii, U.S. territories and protectorates, and most of coastal Alaska.

The windborne debris regions described in the 2006 IBC and IRC are less extensive than what was specified in ANSI/ASCE 7-95. In the 1995 standard, all hurricane-prone areas with a basic wind speed of 110 mph or greater were considered to be windborne debris regions. Now only hurricane-prone areas with a basic wind speed of 110 mph that are within 1 mile of the coast are considered to be in the windborne debris region (except in Hawaii, where all portions of all islands exist, by definition, within the windborne debris region).

The requirements for residential construction are listed in IRC Section R301.2.1.2. This section requires that glazed openings in buildings located in windborne debris regions be protected from windborne debris and that such protection must meet the requirements of the Large Missile Test of an approved impact-resisting standard, or ASTM E1996 and ASTM E1886 (using Missiles C or D). Section 1609.1.2 of the IBC has requirements that take into consideration the use of the building and location of the glazing. Glazed openings within 30 feet of grade must resist the Large Missile Test of ASTM E1996 (using Missile D or E) and glazed openings more than 30 feet above grade must meet the Small Missile Test of ASTM E1996. It is important to understand that when glazing protection is required, it is required for all glazing on a building. It is an incorrect assumption that the protection only needs to be installed to protect openings on the side of the building that receives positive (or predominant) wind pressures. Further, the approved systems need to be inspected for compliance. Figure 10-5 illustrates how a panel shutter was installed incorrectly around window-mounted air conditioning units, leaving much of the window unprotected.

NOTE

Delineating windborne debris regions is not an exact science and would benefit from further research. While post-event assessments indicate that 3-second gust winds as low as 80 mph can dislodge aggregate surfaced roofing with sufficient momentum to damage glazing, recent research suggests that in wooded areas, the 2006 windborne debris regions may be conservative. According to the best practices recommended in recent FEMA MAT reports from the 2004 and 2005 hurricane seasons, windborne debris protection is suggested for all Exposure C areas where wind speeds are 110 mph or greater.



Figure 10-5.
PENSACOLA, FLORIDA:
Shutters had been attached to this building in order to protect it from windborne debris. However, areas above and below the air conditioning units were left unprotected.
(Source: FEMA 489)

ASTM E1886, *Standard Test Method for Performance of Exterior Windows, Curtain Walls, Doors, and Impact Protective Systems Impacted by Missile(s) and Exposed to Cyclic Pressure Differentials* is a consensus-based testing protocol for certifying glazing systems. However, certification to ASTM E1886 in and of itself is not adequate to determine adequacy of a glazing system for a given area.

ASTM E1886 is not a standalone document and requires input from a specifying authority or the AHJ such as a city, county, or state code enforcement office which determines actual testing conditions and regulates compliance with such tests and conditions. The test method standardizes the size and weight of a small missile, the size and range of weights for large missiles at various speeds, and sets forth the methods to test assemblies for missile impacts and subsequent cyclic pressure tests (although it remains the responsibility of the specifying authority to provide the actual testing criteria). These criteria include: number of test specimens, basic wind speed, missile impact speed, number and location of impacts required during certification, and the number of cycles and duration of the cyclic load testing.

NOTE

The Engineering Wood Association (formally the American Plywood Association) has prepared five brochures that present hurricane-resistant shutter design for wood-frame and masonry buildings. The brochures are available online at the Engineering Wood Association Web site at <http://www.apawood.org>.

ASTM E1996 augments ASTM E1886 by specifying the weight of the large missile to be used in testing per ASTM E1886 and the impact velocities for the large and small missiles. The ASTM standards identify more stringent requirements for buildings in higher basic wind speed zones and for critical facilities. Table 10-1 presents two ASTM E1996 large missile requirements for different wind zones and building classifications.

The ASTM standard defines basic protection levels for glazing for all buildings, and for buildings requiring enhanced protection. Section 6.2.1 of ASTM E1996 describes facilities and their required protection level. The wind zones listed in ASTM E1996 are:

Wind Zone 1 – Areas where the basic wind speed is greater than or equal to 110 mph and less than 120 mph, and Hawaii.

Wind Zone 2 – Areas more than 1 mile from the coastline where the basic wind speed is greater than or equal to 120 mph and less than 130. The coastline is delineated by the mean high-water mark.

Wind Zone 3 – Areas where the basic wind speed is greater than or equal to 130 mph and areas within 1 mile of the coastline, where the basic wind speed is greater than or equal to 120 mph.

This may be confusing to designers, builders, and local officials, because it appears that these are different criteria than what is presented in the IBC and IRC. However, this is not the case. The ASTM standard wind zones help define the missile size and speed to be used for debris impact-resistance testing and are needed to carry out the tests required by the codes. Local officials need to closely review the certification of tested glazing systems to determine if they are appropriate for that jurisdiction, building location, and building use. Particular attention should be given to:

- Basic (design) wind speed. (It should match the ASCE 7-05 basic wind speed map or the maps contained in the IRC or IBC.)
- Design wind pressures. (Pressures should be based upon C&C loads per ASCE 7-05, the IBC, or IRC.)
- Size of the appropriate missile (which depends upon building use, building height, and wind speed).

Table 10-1.
(Source: ASTM E1996)

TABLE 2 - Applicable Missiles						
Missile Level	Missile		Impact Speed (m/s)			
A	2 g ± 5% Steel Ball		39.62 (130 f/s)			
B	910 g ± 100 g (2.0 lb. ± 0.25 lb.) 2x4 in. 52.5 cm ± 100mm (1 ft. - 9 in. + 4 in.) Lumber		15.25 (50 f/s)			
C	2050 g ± 100 g (4.5 lb. ± 0.25 lb.) 2x4 in. 1.2 m ± 100mm (4 ft. ± 4 in.) Lumber		12.19 (40 f/s)			
D	4100 g ± 100 g (9.0 lb. ± 0.25 lb.) 2x4 in. 2.4 m ± 100mm (8 ft. ± 4 in.) Lumber		15.25 (50 f/s)			
E	4100 g ± 100 g (9.0 lb. ± 0.25 lb.) 2x4 in. 2.4 m ± 100mm (8 ft. ± 4 in.) Lumber		24.38 (80 f/s)			

TABLE 3 - Description Levels						
NOTE 1 – For Missiles B, C, D and E also use Missile A for porous shutter assemblies (see 8.4)						
Levels of Protection	Enhanced Protection (Essential Facilities)		Basic Protection		Unprotected	
Assembly Height	≤ (30 ft) 9.1 m	≥ (30 ft) 9.1 m	≤ (30 ft) 9.1 m	≥ (30 ft) 9.1 m	≤ (30 ft) 9.1 m	≥ (30 ft) 9.1 m
Wind Zone 1	D	D	C	A	None	None
Wind Zone 2	D	D	C	A	None	None
Wind Zone 3	E	D	D	A	None	None

It is also important to note that wind pressures specified on product approval or certification sheets for shutters, screens, and panel systems are the pressures at which the system was tested for resistance to blow-off. These systems have not been tested to reduce the pressures on the windows and glazing they protect and, therefore, the window or glazing system behind the opening protective device must still be designed to resist the design wind pressure; the protective device only prevents debris impact to the glazing.

Both the IRC and IBC contain exceptions that permit 7/16-inch thick (minimum) wood structural panels to be for used for windborne debris protection. It is important to note that these panels should not have a maximum dimension of more than of 8 feet and they must be properly fastened to the building to resist wind forces appropriate for that location. In addition, when wood structural panels are used for windborne debris protection, the IRC and IBC both require that the panels be: 1) precut, 2) attached to the framing surrounding the glazed openings, 3) secured with attachment hardware provided, and 4) the attachments shall be designed to resist the C&C loads determined in accordance with IBC Section 1609 (i.e. ASCE 7-05). Table R301.2.1.2 of the IRC and Table 1609.1.2 of the IBC contain prescriptive attachment schedules (i.e., details) suitable for buildings with mean roof heights up to 33 feet for basic wind speeds up to 130 mph. Figure 10-6 shows a glazed door that was not protected with any type of system and was subsequently damaged by windborne debris.



Figure 10-6.
PENSACOLA, FLORIDA:
Failure of glazing from windborne
debris created by dislodged tile roofing.
(Source: FEMA 489)

The IBC contains other exceptions, which allow greenhouses with no public access and glazing in the upper floors of taller buildings to be constructed without windborne debris protection. Exceptions to glazing protection in taller buildings apply when: 1) the glazing is at least 60 feet above the ground, and 2) the glazing is located a minimum of 30 feet above any aggregate surfaced roofs within 1,500 feet of the building glazing in question. (These exceptions are consistent with the requirements of ASTM E1996.)

Prescriptive standards generally assume that a building's envelope (e.g., walls, wall coverings, windows, roof decking, roof coverings, etc.) will remain intact and the building will not be damaged by the impact from windborne debris. The assumption is that a hole in the exterior of the building may be created, but it will not expose the inside of the facility to winds that would result in high internal pressures acting on the structural system. ICC-600 requires glazing in windborne debris regions to be protected to meet the large

missile criteria of ASTM E1886 and ASTM E1996 to prevent damage. ASCE 7-05 also states in Section 1.4 that, Buildings and other structures shall be designed to sustain local damage with the structural system as a whole remaining stable and not being damaged to an extent disproportionate to the original local damage. However, it is very important to note that walls, roof decks, and other non-glazed building components are not required to be impact-resistant systems by the IRC, IBC, or ASCE 7-05. Only some state codes (such as the Florida Building Code) contain impact-resistance requirements for non-glazed building components. These requirements are limited to hazard areas defined as High Velocity Hurricane Zones (HVHZ) and only for critical and essential facilities operating within the HVHZs. FEMA 361 and the ICC-500, which provide design criteria for safe rooms and storm shelters, respectively, require all roof, wall, glazing, doors, and openings on the safe room or shelter to be debris-impact resistant.

10.5 Window and Door Leakage

Hurricanes and coastal storms can pose significant problems from water-infiltration due to wind-driven rain. Leakage can occur between the door or window and their frames and between the door/window frames and the walls onto which they are mounted. Coastal storms such as tropical storms and hurricanes generate winds that may approach or exceed the wind speeds observed during design wind events. As such, these winds generate high-wind pressures on the outsides of the buildings, exploiting any vulnerability around doors and windows and allowing water to enter buildings. Further, leakage rates typically increase with greater wind speeds. While the amount of water entry that can result from leakage around windows and doors will typically be much less than the amount of water entry that can result from a breach in the building envelope, actions can and should be taken to help reduce leakage around doors and windows. These actions are often code-plus or best-practices approaches.

10.5.1 Code Requirements for Window and Door Leakage

Proper door and window construction is critical to reducing water infiltration. Section R613.4 of the IRC and Section 1714.5.1 of the IBC require windows and sliding doors to be certified per AAMA/WDMA/CSA 101/LS.2/A440, *Standard/Specification for Windows, Doors, and Unit Skylights*. Hinge doors must be certified per ASTM E330, *Standard Test Method for Structural Performance of Exterior Windows, Doors, Skylights, and Curtain Walls by Uniform Static Air Pressure Difference*. Both standards specify wind-pressure and water-leakage criteria that must be met in order to comply with code requirements.

In general, water-leakage tests are conducted at much lower differential pressures (typically 20 percent) than the pressures used to determine the strength of the glazing, window, or door assembly. This implies that some water entry through doors and windows should be anticipated during an event that produces design wind pressures and wind-driven rain.

10.5.2 Reducing Window and Door Leakage

FEMA 499, Technical Fact Sheet No. 22: *Window and Door Installation*, Window and Door Installation, provides some best-practices approaches that can be taken to reduce water infiltration. Pan flashing (i.e., flashing under window sills), weather stripping, and threshold seals are discussed. Other actions can be taken to reduce the potential for water entry. These include:

Vestibules. Designing a vestibule to protect a door entry is one method of managing water infiltration problems. Through this approach, both the inner and outer doors can be equipped with weather stripping, and the vestibule itself can be designed to tolerate water. For example, water-resistant finishes

(e.g., concrete or tile) can be specified, and the floor can be equipped with a drain. As a result, a secondary layer of protection is provided for the primary entrance (via the vestibule and vestibule door).

Door swing. Out-swinging doors offer an advantage compared to in-swinging door assemblies. With out-swinging door assemblies, the weather stripping is located on the interior side of the door, where it is less susceptible to degradation than the exposed weather stripping on in-swinging door assemblies. Also, some interlocking weather-stripping products are available for out-swinging door assemblies that provide better performance than those used on in-swinging door assemblies.

Finish selection. One design approach to deal with leakage is to avoid running carpet (or other finishes that can be damaged by water) entirely to the edge of walls that contain a large amount of glazing. Instead, a strip of water-resistant material (such as tile) could be specified along the wall so if light to moderate leakage occurs, the potential for damage to interior finishes and contents is greatly reduced.

10.6 Window and Door Assembly Capacities

Window and door assemblies must be strong enough to withstand wind pressures acting on them and be fastened securely enough to transfer those wind pressures to the adjacent wall. Pressure failures of doors or windows can allow glazing to fracture or glazing frames or supports to fail. Anchorage failures can allow entire door or window units to be ripped from their walls, as shown in Figure 10-7. Either type of failure results in the failure of the building envelope and allows wind and water into the building.

10.6.1 Code Requirements for Strength and Anchorage

Both the IRC and IBC contain specific requirements for the wind resistance of windows and doors. Section R613.3 of the IRC requires that exterior windows and doors be designed to resist the wind pressures specified in Table R301.2(2). Table R301.2(2) lists positive and negative wind pressures for C&C for various locations within the building. Areas near roof and wall edges and areas near corners, where turbulence creates localized high wind pressures, must be designed for higher loads. Table R301.2(2)



Figure 10-7.
PUNTA GORDA ISLES, FLORIDA:
Anchorage failure in sliding
glass door failure.
(Source: FEMA 488)

is based upon Exposure B conditions for buildings with a mean roof height of 30 feet or less. Table R301.2(2) pressures must be multiplied by factors listed in Table R301.2(3) for different mean roof heights and exposures.

The IBC requirements are similar but are less prescriptive and more performance-based. While the IRC has tabulated wind pressures, Chapter 16 of the IBC specifies acceptable methods of calculating wind loads and (in Section 1603.1.4) requires that construction documents list wind pressures for C&C.

IBC Section 1405.12, Exterior Windows and Doors, requires windows and doors to be tested in accordance with IBC Section 1714.5, which lists two methods of establishing wind resistance. Section 1714.5.1 allows doors and windows to be labeled per AAMA/WMDA/CSA 101/I.S.2/A440; Section 1714.5.2 allows doors and windows to be tested per ASTM E330. The latter option has additional requirements regarding glass supports and framing that are outlined in Section 2403 and pressure ratings for Section 1714.5.2 are outlined in Chapter 16, the structural design chapter of the IBC.

AAMA/WMDA/CSA 101/I.S.2/A440 lists design test pressures of 15, 25, 30, and 40 psf. Windows and doors used in areas where wind pressures are greater than 40 psf need to be tested per ASTM E330. For residential construction, local officials must ensure that products proposed are adequate to resist the C&C loads of Table R301.2(2). For engineered construction, the designer should specify wind pressures required for windows and doors and should base them on C&C loads from either Chapter 6 of ASCE 7-05 or Chapter 16 of the IBC.

Section R613.8.1 of the IRC requires that windows and glass doors be anchored in accordance with published manufacturer's recommendations. The manufacturer's installation instructions should match those used when the units were tested and certified. Substitute anchorage systems are allowed if they provide equal or greater anchoring performance as demonstrated by accepted engineering practice.

IRC contains Figures R613.8(1) through R613.8(8) that provide minimum anchorage details. The details require windows and doors to be anchored in a fashion that adequately transfers loads from the windows and doors to the adjacent walls (the walls are called substrates in that code). When the space between the window or door frame and the wall's rough opening is 1½ inches or less, shims or bucks can be installed and fasteners can extend from the door or window frame to the wall. When the space is greater than 1½ inches, the bucks need to be securely fastened to the wall and the door, or window frames need to be securely fastened to the bucks. This requirement limits the shear length of fasteners to 1½ inches and reduces the potential for bending failures in the fasteners.

The IBC requirements are similar but do not provide the prescriptive details contained in the IRC. IBC Section 1405.12.1 requires windows and doors to be installed in accordance with approved manufacturer's instructions. The IBC requires fastener size and spacing be provided in the instructions and that the fastener size and spacing be based upon the maximum loads used in certification or compliance tests.

For adequate performance, the manufacturer's installation instructions must be followed. Local authorities should require that the installation instructions be present onsite. Further, installations should be inspected to ensure that compliance has been achieved with those instructions.

To minimize issues related to corrosion, the use of fiberglass or vinyl frames are recommended for buildings located within 3,000 feet of an ocean shoreline. The use of stainless steel frame anchors, fasteners, and hardware is also recommended within these areas. In areas where severe termite or insect infestation problems exist, wood frames should either be treated or should be constructed with wood that is naturally insect- and rot-resistant. Shims and bucks should be pressure-treated. Since some pressure treatment increases the moisture content of framing, the use of material that is kiln dried after treatment is suggested to control shrinkage.

In areas where insect infestation problems exist, metal door assemblies are recommended. If concrete, masonry, or metal wall construction is used to eliminate termite problems, wood used for blocking or bucks should be treated or naturally insect- and rot-resistant species of wood should be used.

10.7 Garage Doors

Post-event hurricane and tornado assessments include numerous examples of failures of garage (or vehicle-access) doors. Garage doors have experienced:

- **Outward-acting Suction Failures.** Doors have buckled and pulled outward, as shown in Figure 10-8.
- **Inward-acting Positive Pressure Failures.** Doors have buckled or pushed inward, as shown in Figure 10-9.
- **Hardware Failures.** Failures in the hardware that laterally supports garage doors and allows them to open and close.

Failures of garage doors can allow significant amounts of water and wind to enter a building. Because it is common for garages to be constructed (at least in part) with water-resistant materials, water entry is often less of a concern than the internal pressure increase that garage-door failures create. A garage-door failure is a breach of the building envelope. The breach increases internal pressures within that area of the building and may lead to building failure.

Because of their size and relatively long spans (as compared to windows and other doors), garage doors must resist higher forces from the same wind pressures that act on windows and access doors. However, garage doors typically have room to deflect more than windows and access doors and the increased deflection can be used to resist loads (provided that the tracks do not fail).

Section R613.5 of the IRC requires garage doors to be tested in accordance with ASTM E330, *Standard Test Method for Structural Performance of Exterior Windows, Doors, Skylights, and Curtain Walls by Uniform Static Air Pressure Difference* or ANSI/DASMA 108, *Standard Method for Testing Sectional Garage Doors: Determination of Structural Performance Under Uniform Static Air Pressure Difference* and requires doors to meet the acceptance criteria of ANSI/DASMA 108. ASTM E330 establishes the methods used to apply and measure wind pressures; ANSI/DASMA 108 establishes failure criteria related to building failure.

Like the testing of windows and doors per AAMA/WDMA/CSA 101/I.S.2/A440, neither ASTM E330 nor ANSI/DASMA 108 establishes test pressures. Therefore certification data must be closely examined to determine if the labeled product is appropriate for the design wind pressures at the proposed location. Also, some municipalities require garage doors to be tested at pressures in excess of the design wind pressures. The C&C wind pressures in Table R301.2(2) of the IRC provide minimum design pressures that the labeled door should meet.

Table R301.2(2) lists positive and negative wind pressures on C&C for basic wind speeds between 85 mph and 170 mph. Positive pressures act toward the building surface; negative pressures act away from the building surface. As discussed in Section 10.6, the listed pressures relate to Exposure B conditions for buildings with a 30 foot mean roof height; the values must be multiplied by the adjustment factors listed in Table R301.2(3) for other exposure categories and other mean roof heights.



Figure 10-8.
Negative pressure failure
of garage door.
 (Source: FEMA 488)



Figure 10-9.
Positive pressure failure
of garage door.
 (Source: FEMA 549)

Table R301.2(2) also lists wind pressures for various locations within a building that constitute effective wind areas. The locations include three areas specified for the roof (Zones 1, 2, and 3 corresponding to the interior, corner, and eave and gable zones) and two areas specified for the walls (Zones 4 and 5). Zone 4 wall pressures are for locations away from corners; Zone 5 pressures are for areas within 4 feet of the corner, where wind pressures are higher. IRC Figure R301.2(7) graphically shows the locations of the C&C wind zones.

While some manufacturers provide wind speed and exposure ratings for their products, labels on many garage doors do not include wind speed or wind pressure ratings. While not required to be included on the product labeling, ANSI/DASMA 108 does require that the positive and negative pressure used in testing be recorded on the ANSI/DASMA 108 Test Report Form. The standard also requires that the model number, description, and operating hardware be documented. Where wind speed or wind pressures are not specifically provided for the product, builders and officials can refer to the Test Report Form to ensure that the garage door assembly has been tested to resist the design wind pressures listed in Table R301.2(2). In windborne debris regions, the IRC Section R301.1,2 also requires that glazing in garage doors be protected from windborne debris.

10.8 Additional Resources

American Society for Testing and Materials:

- ASTM E1886, *Performance of Exterior Windows, Curtain Walls, Doors, and Storm Shutters Impacted by Missile(s) and Exposed to Cyclic Pressure Differentials*
- ASTM E1996, *Standard Specification for Performance of Exterior Windows, Curtain Walls, Doors and Impact Protective Systems Impacted by Windborne Debris in Hurricane;*
- ASTM E2112, *Standard Practice for Installation of Exterior Windows, Doors and Skylights*
- ASTM E330, *Structural Performance of Exterior Windows, Doors, Skylights and Curtain Walls by Uniform Static Air Pressure Difference.* (www.astm.org)

American National Standards Institute:

- ANSI/DASMA 108, *Standard Method for Testing Sectional Garage Doors: Determination of Structural Performance Under Uniform Static Air Pressure Difference*

APPENDIX A

No. _____

FLOODPLAIN DEVELOPMENT PERMIT

Specify for what purpose the permit is issued -
New construction, alterations, fill, excavation, other
(circle one)

ISSUED TO: _____

ADDRESS: _____

PROJECT ADDRESS: _____
(if different from permittee's address)

ISSUED BY: _____
Floodplain Management Administrator

DATE: _____
(This permit expires 180 days from this date)

THIS PERMIT MUST BE POSTED ON THE PREMISES IN A CONSPICUOUS PLACE SO AS TO BE
CLEARLY VISIBLE FROM THE STREET.

U.S. DEPARTMENT OF HOMELAND SECURITY
Federal Emergency Management Agency
National Flood Insurance Program

ELEVATION CERTIFICATE

OMB No. 1660-0008
Expires March 31, 2012

Important: Read the instructions on pages 1-9.

SECTION A - PROPERTY INFORMATION		For Insurance Company Use:
A1. Building Owner's Name		Policy Number
A2. Building Street Address (including Apt., Unit, Suite, and/or Bldg. No.) or P.O. Route and Box No.		Company NAIC Number
City	State	ZIP Code
A3. Property Description (Lot and Block Numbers, Tax Parcel Number, Legal Description, etc.)		
A4. Building Use (e.g., Residential, Non-Residential, Addition, Accessory, etc.)		
A5. Latitude/Longitude: Lat. _____ Long. _____ Horizontal Datum: <input type="checkbox"/> NAD 1927 <input type="checkbox"/> NAD 1983		
A6. Attach at least 2 photographs of the building if the Certificate is being used to obtain flood insurance.		
A7. Building Diagram Number _____		
A8. For a building with a crawlspace or enclosure(s):		A9. For a building with an attached garage:
a) Square footage of crawlspace or enclosure(s) _____ sq ft		a) Square footage of attached garage _____ sq ft
b) No. of permanent flood openings in the crawlspace or enclosure(s) within 1.0 foot above adjacent grade _____		b) No. of permanent flood openings in the attached garage within 1.0 foot above adjacent grade _____
c) Total net area of flood openings in A8.b _____ sq in		c) Total net area of flood openings in A9.b _____ sq in
d) Engineered flood openings? <input type="checkbox"/> Yes <input type="checkbox"/> No		d) Engineered flood openings? <input type="checkbox"/> Yes <input type="checkbox"/> No

SECTION B - FLOOD INSURANCE RATE MAP (FIRM) INFORMATION					
B1. NFIP Community Name & Community Number		B2. County Name		B3. State	
B4. Map/Panel Number	B5. Suffix	B6. FIRM Index Date	B7. FIRM Panel Effective/Revised Date	B8. Flood Zone(s)	B9. Base Flood Elevation(s) (Zone AO, use base flood depth)
B10. Indicate the source of the Base Flood Elevation (BFE) data or base flood depth entered in Item B9. <input type="checkbox"/> FIS Profile <input type="checkbox"/> FIRM <input type="checkbox"/> Community Determined <input type="checkbox"/> Other (Describe) _____					
B11. Indicate elevation datum used for BFE in Item B9: <input type="checkbox"/> NGVD 1929 <input type="checkbox"/> NAVD 1988 <input type="checkbox"/> Other (Describe) _____					
B12. Is the building located in a Coastal Barrier Resources System (CBRS) area or Otherwise Protected Area (OPA)? <input type="checkbox"/> Yes <input type="checkbox"/> No Designation Date _____ <input type="checkbox"/> CBRS <input type="checkbox"/> OPA					

SECTION C - BUILDING ELEVATION INFORMATION (SURVEY REQUIRED)	
C1. Building elevations are based on: <input type="checkbox"/> Construction Drawings* <input type="checkbox"/> Building Under Construction* <input type="checkbox"/> Finished Construction <small>*A new Elevation Certificate will be required when construction of the building is complete.</small>	
C2. Elevations – Zones A1-A30, AE, AH, A (with BFE), VE, V1-V30, V (with BFE), AR, AR/A, AR/AE, AR/A1-A30, AR/AH, AR/AO. Complete Items C2.a-h below according to the building diagram specified in Item A7. Use the same datum as the BFE. Benchmark Utilized _____ Vertical Datum _____ Conversion/Comments _____	
Check the measurement used.	
a) Top of bottom floor (including basement, crawlspace, or enclosure floor) _____	<input type="checkbox"/> feet <input type="checkbox"/> meters (Puerto Rico only)
b) Top of the next higher floor _____	<input type="checkbox"/> feet <input type="checkbox"/> meters (Puerto Rico only)
c) Bottom of the lowest horizontal structural member (V Zones only) _____	<input type="checkbox"/> feet <input type="checkbox"/> meters (Puerto Rico only)
d) Attached garage (top of slab) _____	<input type="checkbox"/> feet <input type="checkbox"/> meters (Puerto Rico only)
e) Lowest elevation of machinery or equipment servicing the building (Describe type of equipment and location in Comments) _____	<input type="checkbox"/> feet <input type="checkbox"/> meters (Puerto Rico only)
f) Lowest adjacent (finished) grade next to building (LAG) _____	<input type="checkbox"/> feet <input type="checkbox"/> meters (Puerto Rico only)
g) Highest adjacent (finished) grade next to building (HAG) _____	<input type="checkbox"/> feet <input type="checkbox"/> meters (Puerto Rico only)
h) Lowest adjacent grade at lowest elevation of deck or stairs, including structural support _____	<input type="checkbox"/> feet <input type="checkbox"/> meters (Puerto Rico only)

SECTION D - SURVEYOR, ENGINEER, OR ARCHITECT CERTIFICATION	
This certification is to be signed and sealed by a land surveyor, engineer, or architect authorized by law to certify elevation information. I certify that the information on this Certificate represents my best efforts to interpret the data available. I understand that any false statement may be punishable by fine or imprisonment under 18 U.S. Code, Section 1001.	
<input type="checkbox"/> Check here if comments are provided on back of form. Were latitude and longitude in Section A provided by a licensed land surveyor? <input type="checkbox"/> Yes <input type="checkbox"/> No	
Certifier's Name	License Number
Title	Company Name
Address	City State ZIP Code
Signature	Date Telephone

PLACE SEAL HERE

IMPORTANT: In these spaces, copy the corresponding information from Section A.		For Insurance Company Use:	
Building Street Address (including Apt., Unit, Suite, and/or Bldg. No.) or P.O. Route and Box No.		Policy Number	
City	State	ZIP Code	Company NAIC Number

SECTION D - SURVEYOR, ENGINEER, OR ARCHITECT CERTIFICATION (CONTINUED)

Copy both sides of this Elevation Certificate for (1) community official, (2) insurance agent/company, and (3) building owner.

Comments

Signature _____ Date _____ Check here if attachments

SECTION E - BUILDING ELEVATION INFORMATION (SURVEY NOT REQUIRED) FOR ZONE AO AND ZONE A (WITHOUT BFE)

For Zones AO and A (without BFE), complete Items E1-E5. If the Certificate is intended to support a LOMA or LOMR-F request, complete Sections A, B, and C. For Items E1-E4, use natural grade, if available. Check the measurement used. In Puerto Rico only, enter meters.

E1. Provide elevation information for the following and check the appropriate boxes to show whether the elevation is above or below the highest adjacent grade (HAG) and the lowest adjacent grade (LAG).

a) Top of bottom floor (including basement, crawlspace, or enclosure) is _____ feet meters above or below the HAG.

b) Top of bottom floor (including basement, crawlspace, or enclosure) is _____ feet meters above or below the LAG.

E2. For Building Diagrams 6-9 with permanent flood openings provided in Section A Items 8 and/or 9 (see pages 8-9 of Instructions), the next higher floor (elevation C2.b in the diagrams) of the building is _____ feet meters above or below the HAG.

E3. Attached garage (top of slab) is _____ feet meters above or below the HAG.

E4. Top of platform of machinery and/or equipment servicing the building is _____ feet meters above or below the HAG.

E5. Zone AO only: If no flood depth number is available, is the top of the bottom floor elevated in accordance with the community's floodplain management ordinance? Yes No Unknown. The local official must certify this information in Section G.

SECTION F - PROPERTY OWNER (OR OWNER'S REPRESENTATIVE) CERTIFICATION

The property owner or owner's authorized representative who completes Sections A, B, and E for Zone A (without a FEMA-issued or community-issued BFE) or Zone AO must sign here. *The statements in Sections A, B, and E are correct to the best of my knowledge.*

Property Owner's or Owner's Authorized Representative's Name _____

Address _____ City _____ State _____ ZIP Code _____

Signature _____ Date _____ Telephone _____

Comments _____

Check here if attachments

SECTION G - COMMUNITY INFORMATION (OPTIONAL)

The local official who is authorized by law or ordinance to administer the community's floodplain management ordinance can complete Sections A, B, C (or E), and G of this Elevation Certificate. Complete the applicable item(s) and sign below. Check the measurement used in Items G8 and G9.

G1. The information in Section C was taken from other documentation that has been signed and sealed by a licensed surveyor, engineer, or architect who is authorized by law to certify elevation information. (Indicate the source and date of the elevation data in the Comments area below.)

G2. A community official completed Section E for a building located in Zone A (without a FEMA-issued or community-issued BFE) or Zone AO.

G3. The following information (Items G4-G9) is provided for community floodplain management purposes.

G4. Permit Number _____	G5. Date Permit Issued _____	G6. Date Certificate Of Compliance/Occupancy Issued _____
-------------------------	------------------------------	---

G7. This permit has been issued for: New Construction Substantial Improvement

G8. Elevation of as-built lowest floor (including basement) of the building _____ feet meters (PR) Datum _____

G9. BFE or (in Zone AO) depth of flooding at the building site _____ feet meters (PR) Datum _____

G10. Community's design flood elevation _____ feet meters (PR) Datum _____

Local Official's Name _____ Title _____

Community Name _____ Telephone _____

Signature _____ Date _____

Comments _____

Check here if attachments

FEMA Form 81-31, Mar 09 Replaces all previous editions

Building Photographs

See Instructions for Item A6.

Building Street Address (including Apt., Unit, Suite, and/or Bldg. No.) or P.O. Route and Box No.			For Insurance Company Use:
			Policy Number
City	State	ZIP Code	Company NAIC Number

If using the Elevation Certificate to obtain NFIP flood insurance, affix at least two building photographs below according to the instructions for Item A6. Identify all photographs with: date taken; "Front View" and "Rear View"; and, if required, "Right Side View" and "Left Side View." If submitting more photographs than will fit on this page, use the Continuation Page on the reverse.

Building Photographs

Continuation Page

Building Street Address (including Apt., Unit, Suite, and/or Bldg. No.) or P.O. Route and Box No.			For Insurance Company Use: Policy Number
City	State	ZIP Code	Company NAIC Number

If submitting more photographs than will fit on the preceding page, affix the additional photographs below. Identify all photographs with: date taken; "Front View" and "Rear View"; and, if required, "Right Side View" and "Left Side View."

The FEMA NFIP *Elevation Certificate and Instructions* can be downloaded from the FEMA library at <http://www.fema.gov/business/nfip/elvinst.shtm>.

V-Zone Certification				
Property Information			For Insurance Company Use	
Name of Building Owner			Policy Number	
Building Address or Other Description				
City			State	Zip Code
SECTION I: FLOOD INSURANCE RATE MAP (FIRM) INFORMATION				
<i>Note: to be obtained from appropriate FIRMs</i>				
Community Number	Panel Number	Suffix	Date of FIRM Index	FIRM Zone
SECTION II: ELEVATION INFORMATION				
<i>Note: This form is not a substitute for an Elevation Certificate. Elevations should be rounded to nearest tenth of a foot.</i>				
1. Elevation of the Bottom of Lowest Horizontal Structure Member				feet
2. Base Flood Elevation				feet
3. Elevation of Lowest Adjacent Grade				feet
4. Approximate Depth of Anticipated Scour/Erosion Used for Foundation Design				feet
5. Embedment Depth of Pilings or Foundation Below Lowest Adjacent Grade				feet
6. Datum Used: _____	NGVD '29	NAVD '88	Other	
SECTION III: FLOOD INSURANCE RATE MAP (FIRM) INFORMATION				
<i>Note: This section must be certified by a registered professional engineer or architect</i>				
I certify that I have developed or reviewed the structural design, plans and specifications for construction and that the methods of construction to be used are in accordance with accepted standards of practice for meeting the following provisions:				
a) The bottom of the lowest horizontal structure member of the lowest floor (excluding the pilings or columns) is elevated to or above the BFE; and,				
b) The pile or column foundation and structure attached thereto is anchored to resist flotation, collapse and lateral movement due to the effects of the wind and water loads acting simultaneously on all building components. Water loading values used are those associated with the base flood including wave action. Wind loading values used are those required by the applicable State or local building code. The potential for scour and erosion at the foundation has been anticipated for conditions associated with the flood, including wave action.				
SECTION IV: FLOOD INSURANCE RATE MAP (FIRM) INFORMATION				
<i>Note: This section must be certified by a registered professional engineer or architect</i>				
I certify that I have developed or reviewed the structural design, plans and specifications for construction and that the design and methods of construction to be used for the breakaway walls are in accordance with accepted standards of practice for meeting the following provisions:				
c) Breakaway collapse shall result from water load less than that which would occur during the base flood; and,				
d) The elevated portion of the building and supporting foundation system shall not be subject to collapse, displacement, or other structural damage due to the effects of wind and water loads acting simultaneously on all building components (wind and water loading values defined in Section III)..				
SECTION V: CERTIFICATION				
<i>(Check: Section III _____ and/or Section IV _____)</i>				
Name of Certifier			Title	
Firm Name			License Number	
Street Address			Phone Number (_____)	
City			State	Zip Code
Signature			Date	

Figure 5-18: Sample V Zone certification

NOTE

The V-zone certificate is not a substitute for and can not be used without the NFIP Elevation Certificate (see Fact Sheet No. 4), which is required for flood insurance rating.

Checklist for Permit Review

General

- Structural systems resistant to flotation, collapse, or permanent lateral loading
- DFE consistent with the site's location on the applicable FIRM
- Mechanical and electrical systems elevated to at or above the DFE
- Water and sewer designed to allow minimum infiltration from flood waters, or prevent it entirely
- Materials below the DFE are resistant to prolonged water exposure
- All areas below the DFE are designed for a use consistent with NFIP regulations
- Site drainage that will reduce exposure to flooding
- Foundation designed to resist erosion and scour
- Submitted appropriate geotechnical (soils) information
- Floor framing perpendicular to wave action
- Corrosion-resistant exterior connections
- Proper splices for long girders
- Verification of the wind exposure classification
- Key connections in place to allow a continuous load path
 - Uplift resistant connection to transfer loads from main floor to foundation
 - Upper walls transfer loads to lower walls, bypassing floors
 - Roof loads transferred to walls
 - Sufficient roof system and roof framing to resist uplift
- Shear walls properly specified materials and fastened properly
- Openings in the shear walls designed so as to not compromise their strength

- Appropriate roofing system specified given wind speed requirements
- If CMU construction is specified, it is appropriately reinforced and roof elements properly connected
- Flashing roof/window sufficient for wind-driven rain.

Seismic

- Connection sufficient to resist applicable lateral loads
- Roofing system seismic-resistant and included in loading calculations

A-Zone

- Crawlspace equipped with flood openings 1 inch 2 per 1 square foot of area
- Stem walls properly backfilled and compacted
- Foundation walls are solid foundation walls
- Pier foundation sufficiently designed for overturning, due to wind, flood, erosion, scour, and seismic loads
- Pile foundation adequately detailed, including: size, installation method, embedment depth, bracing and proper connection to the structure. (Is it resistant to vertical and horizontal loading? Are any diagonal piles required?)
- Fill is properly stabilized, sloped, and compacted
- Breakaway walls utilized reflect design sufficient to resist 10 psf of force, but not to exceed 20 psf
- Any ramps and stairways designed to resist flood-related loads and (in the event design flood conditions are met) will break away without causing damage to the main structure
- Any garages evaluated against requirements of ASCE 24 Section 9.3
- Any chimneys or fireplaces evaluated against requirements of ASCE 24 Section 9.4
- Any swimming pools evaluated against the requirements of ASCE 24 Section 9.5

V-Zone

- ❑ Pier foundation sufficiently designed for overturning, due to wind, flood, erosion, scour, and seismic loads
- ❑ Pile foundation adequately detailed, including: size, installation method, embedment depth, bracing, and proper connection to the structure. Pile foundation evaluated for resistance to vertical and horizontal loading. (Are any diagonal piles required?)
- ❑ Breakaway walls utilized reflect design sufficient to resist 10 psf of force, but not to exceed 20 psf
- ❑ Are any ramps and stairways designed to resist flood-related loads and (in the event design flood conditions are met) will break away without causing damage to the main structure
- ❑ Garages meet requirements of ASCE 24 Section 9.3
- ❑ Chimneys and fireplaces meet requirements of ASCE 24 Section 9.4
- ❑ Swimming pools meet requirements of ASCE 24 Section 9.5

Roofing

- ❑ Plans explain proposed installation techniques and cover whether materials are corrosion-resistant, and whether any dissimilar metals are in contact with each other
- ❑ Review of substitutions to the manufacturer’s specifications about the roof system

Exterior Cladding

- ❑ Connections suitable for hazards and resistant to water intrusion

Doors and Windows

- ❑ Doors and windows meet wind load requirements, including any appropriate missile-impact requirements
- ❑ All connections and materials corrosion-resistant
- ❑ Locations consistent with shear wall requirements. (Substitutions for larger openings cannot be made without consent of the engineer)

Utilities

- ❑ All utilities properly elevated to at or above the DFE
- ❑ All utilities properly attached and anchored to their supports

SAMPLE

Application #: _____

Applicant: _____

Plan Review Checklist

FLOOD HAZARD AREA APPLICATION REVIEW – V ZONES

Terms: FHA = Flood Hazard Area; DFE = Design Flood Elevation

Reviewer's Initials and Date of Review	Review Steps <i>NOTE: For variance requests, use this form to document efforts to achieve the greatest degree of compliance.</i>
	Is proposed development consistent with zoning? <input type="checkbox"/> NO. Applicant to request a zoning amendment. <input type="checkbox"/> YES. Proceed with review.
	Is proposal in Coastal Barrier Resources Area (CoBRA) or Otherwise Protected Area? <input type="checkbox"/> NO, continue review. <input type="checkbox"/> YES, advise applicant that flood insurance is not available, document to file, continue review (must comply with flood provisions).
FIRM Panel # and date _____ DFE _____	Check FIRM, floodplain and zone boundaries, base flood elevations, <u>and</u> map revisions or LOMRs issued by FEMA. Is proposal in the Coastal Flood Hazard Area subject to high velocity wave action (V Zone)? <input type="checkbox"/> NO, not in Flood Hazard Area; sign and date this form and put in file. <input type="checkbox"/> NO, in "Coastal A Zone" (apply V Zone requirements). <input type="checkbox"/> NO, in riverine A Zone. Use A Zone checklist. <input type="checkbox"/> YES, in V Zone, must meet flood resistant provisions of the code.
	Site plan shows development proposal, location, dimensions, wetlands, FHA /V Zone boundaries, DFE, and ground elevations (NGVD or other datum on FIRM). <input type="checkbox"/> YES, continue review. <input type="checkbox"/> NO, return to applicant to revise application and site plan.
	Can the proposed development be modified to avoid FHA /V Zone? <input type="checkbox"/> YES. Explain flood hazards to applicant and make recommendations to minimize flood hazards and damage potential. <input type="checkbox"/> NO. Can floodplain impacts be further minimized? Maximize setback from the water? Buildings moved to higher elevation?
	Has the applicant obtained and provided copies of all necessary State and federal permits, e.g., wetlands, coastal zone consistency? <input type="checkbox"/> NO, advise applicant which agencies to contact. <input type="checkbox"/> YES, require copies in the file.
	Will a dune be altered? <input type="checkbox"/> NO, continue review. <input type="checkbox"/> YES. Require State coastal zone approval before continuing.
	Is a pool proposed? <input type="checkbox"/> NO. Continue review. <input type="checkbox"/> YES, not attached to the building; continue review. <input type="checkbox"/> YES, attached to the building. Continue review only if included in foundation design.

SAMPLE

Permit #: _____

Date: _____

Applicant: _____

Inspection Checklist

FLOOD HAZARD AREA INSPECTIONS – V ZONES

Inspector's Initials and Date of Inspection	Inspection Steps
	Before site inspection: <input type="checkbox"/> REVIEW permit file before going in the field. <input type="checkbox"/> ASK permit reviewer questions to understand requirements. <input type="checkbox"/> Are other State and federal permits in the file?
	Measure distances from landmark. Is development in the right place? <input type="checkbox"/> NO. Take enforcement action to correct problems. <input type="checkbox"/> YES. Continue inspection.
	Elevation of lowest floor checked during framing or foundation inspection after lowest floor is in place. Elevations checked and acceptable? <input type="checkbox"/> YES. <input type="checkbox"/> NO! Take enforcement action to correct problems.
	For enclosures below DFE: Are walls insect screening or lattice? Are walls breakaway, and no utilities attached to or penetrate breakaway walls? Are flood damage resistant materials used? Does use of enclosure appear to be limited to parking, building access, or limited storage? <input type="checkbox"/> YES. <input type="checkbox"/> Building does not have enclosures. <input type="checkbox"/> NO! Take enforcement action to correct problems.
	Other Notes Based on Inspection:
	Issue Occupancy Certificate only if final inspection shows compliance with floodplain requirements.

FINAL INSPECTION COMPLETED BY: _____ DATE: _____

SAMPLE

Application #: _____

Applicant: _____

Plan Review Checklist

FLOOD HAZARD AREA APPLICATION REVIEW – A ZONES

Terms: FHA = Flood Hazard Area; DFE = Design Flood Elevation

Reviewer's Initials and Date of Review	Review Steps
	<p><i>NOTE: For variance requests, use this form to document efforts to achieve the greatest degree of compliance.</i></p> <p>Is proposed development consistent with zoning?</p> <p><input type="checkbox"/> NO. Applicant to request a zoning amendment.</p> <p><input type="checkbox"/> YES. Proceed with review.</p>
<p>FIRM Panel # and date _____</p> <p>FLOODWAY Panel # and date _____</p> <p>DFE _____</p>	<p>Check FIRM, floodplain/floodway boundaries, base flood elevations, <u>and</u> map revisions and LOMRs issued by FEMA. Is proposal in the floodplain and/or floodway?</p> <p><input type="checkbox"/> NO. Sign and date this form and put in file.</p> <p><input type="checkbox"/> YES. Must meet the flood resistant provisions of the code.</p> <p><input type="checkbox"/> YES, FLOODWAY. All residential structures (including Manufactured Housing units) in floodways to comply with IBC[®].</p> <p><input type="checkbox"/> YES, FLOODWAY. Require engineer's "no rise" analysis and supporting hydraulic data in file before continuing review.</p> <p><input type="checkbox"/> YES, in FHA without DFEs. Check other sources, use estimating methods, or require applicant to determine.</p> <p><input type="checkbox"/> YES, in FHA, but applicant has elevation data that shows natural site elevation above DFE. Advise applicant to obtain LOMA and submit copy for the file.</p> <p><input type="checkbox"/> YES, in Coastal A Zone; refer to V Zone Checklist if V Zone requirements are applied.</p> <p><input type="checkbox"/> YES, in 500-year floodplain. Floodplain review not required; flood-resistance encouraged.</p>
	<p>Site plan shows nature of development proposal, location, dimensions, wetlands, floodplain/floodway boundaries, and ground elevations.</p> <p><input type="checkbox"/> YES, continue review.</p> <p><input type="checkbox"/> NO, return to applicant to revise application and site plan.</p>
	<p>Can the proposed development be modified to avoid floodplain?</p> <p><input type="checkbox"/> YES. Explain flood hazards to applicant and make recommendations to minimize flood hazards and damage potential.</p> <p><input type="checkbox"/> NO, but can impacts be further minimized? Can fill be minimized? Buildings moved to higher ground?</p>
	<p>Has the applicant obtained and provided copies of all necessary State and federal permits, e.g., wetlands?</p> <p><input type="checkbox"/> NO, advise applicant which agencies to contact.</p> <p><input type="checkbox"/> YES, require copies for the file.</p>
	<p>Will a watercourse be altered?</p> <p><input type="checkbox"/> NO. Continue review.</p> <p><input type="checkbox"/> YES. Applicant to provide copies of notices to adjacent communities, federal agencies, and the NFIP State Coordinator.</p> <p><input type="checkbox"/> YES. Engineer's analysis required to show same flood carrying capacity; method of maintenance specified.</p>
	<p>Is fill proposed? Will fill be compacted? Side-slopes are no steeper than 2:1? Protected from erosion?</p> <p><input type="checkbox"/> NO fill. Continue review.</p> <p><input type="checkbox"/> YES, fill used to elevate building will be compacted, sloped, and stabilized.</p> <p><input type="checkbox"/> YES, but not for building elevation. Purpose for fill: _____</p>

SAMPLE

Permit #: _____

Date: _____

Applicant: _____

Inspection Checklist

FLOOD HAZARD AREA INSPECTIONS – A ZONES

Inspector's Initials and Date of Inspection	Inspection Steps
	Before site inspection: <input type="checkbox"/> REVIEW permit file before going in the field. <input type="checkbox"/> ASK permit reviewer questions to understand requirements. <input type="checkbox"/> Are other State and federal permits in the file?
	Measure stake out distances from waterway or landmark. Is development in the right place? Is fill correct distance from waterway or landmark? <input type="checkbox"/> NO. Take enforcement action to correct problems. <input type="checkbox"/> YES. Check fill compaction and side slopes. Basements into fill not allowed.
	Elevation of lowest floor checked during framing or foundation inspection after lowest floor is in place. Elevations checked and acceptable? <input type="checkbox"/> YES. <input type="checkbox"/> NO! Take enforcement action to correct problems.
	For enclosures below DFE (including crawl spaces): Are flood damage resistant materials used? Does use of enclosure appear to be limited to crawl space, parking, building access, or limited storage? Are flood openings no more than 12" above grade? Are there enough flood openings (based on total net open area), are they on at least two sides, and do they allow automatic entry/exit of floodwater? <input type="checkbox"/> YES. <input type="checkbox"/> Building does not have enclosures below DFE. <input type="checkbox"/> NO! Take enforcement action to correct problems.
	Other Notes Based on Inspection:
	Issue Occupancy Certificate only if final inspection shows compliance with floodplain requirements.

FINAL INSPECTION COMPLETED BY: _____ DATE: _____



FEMA

FEMA P-762
Catalog No. 09064-1

