



# Home Builder's Guide to Coastal Construction

Technical Fact Sheet Series

FEMA P-499 / December 2010



**FEMA**



# Coastal Construction Fact Sheet Series

HOME BUILDER'S GUIDE TO COASTAL CONSTRUCTION

Technical Fact Sheet No. G.1

GUIDE  
G

## Introduction

FEMA has produced a series of 37 fact sheets that provide technical guidance and recommendations concerning the construction of **coastal residential buildings**. The fact sheets present information aimed at improving the performance of buildings subject to flood and wind forces in coastal environments. The fact sheets make extensive use of photographs and drawings to illustrate National Flood Insurance Program (NFIP) regulatory requirements, the proper siting of coastal buildings, and recommended design and construction practices, including structural connections, the building envelope, utilities, and accessory structures. In addition, many of the fact sheets include lists of additional resources that provide more information about the topics discussed.

## Available Fact Sheets

The following 37 fact sheets are also available on the FEMA website ([www.fema.gov](http://www.fema.gov)) as Adobe® Portable Document Format (PDF) files and as plain text (.txt) files. You must have Adobe® Reader to view the PDF files. The latest version of Adobe Reader is recommended. Download the free Reader from [www.adobe.com](http://www.adobe.com).

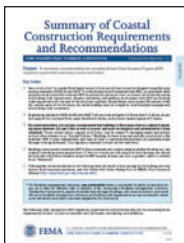
**Note:** The fact sheets have been divided into 10 different categories, which represent various building components or aspects of the construction process. Fact sheets are numbered first by the category and then followed by a number to represent the fact sheet within the category. Future updates to the guide will include fact sheets using these categories and will allow the user to add new fact sheets within the category without requiring the entire guide to be reprinted. Revisions to individual sheets will include a letter behind the numbers to represent each successive update.

## Category 1 – General



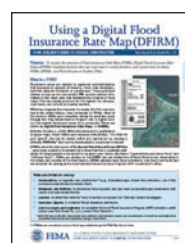
**Fact Sheet No. 1.1, Coastal Building Successes and Failures** – Explains how coastal construction requirements differ from those for inland construction, and discusses the characteristics that make for a successful coastal residential building. Includes

design and construction recommendations for achieving building success.



**Fact Sheet No. 1.2, Summary of Coastal Construction Requirements and Recommendations for Flood Effects** – Summarizes recommendations for exceeding NFIP regulatory requirements for new construction and for repairs, remodeling, and additions.

Topics include building foundations, enclosures below the Base Flood Elevation (BFE), use of nonstructural fill, use of space below the BFE, utilities, certification requirements, and repairs, remodeling, and additions. Cross-references to related fact sheets are provided.



**Fact Sheet No. 1.3, Using a Digital Flood Insurance Rate Map (DFIRM)** – Explains the purpose of Flood Insurance Rate Maps (FIRMs) and Digital Flood Insurance Rate Maps (DFIRMs); highlights features that are important to coastal builders, including flood zones and flood elevations; and explains how to obtain FIRMs, DFIRMs, and Flood Insurance Studies (FISs).



**Fact Sheet No. 1.4, Lowest Floor Elevation** – Defines “lowest floor,” discusses benefits of exceeding the NFIP minimum building elevation requirements, identifies common construction practices that are violations of NFIP regulations, which result in significantly higher flood insurance premiums; and discusses the NFIP Elevation Certificate. Also includes a copy of the certificate.



FEMA

G.1: COASTAL CONSTRUCTION FACT SHEET SERIES

HOME BUILDER'S GUIDE TO COASTAL CONSTRUCTION

1 of 6

12/10



**Fact Sheet No. 1.5, V Zone Design Certification** – Explains the certification requirements for structural design and methods of construction in V Zones. Also includes a copy of a sample certificate and explains how to complete it.



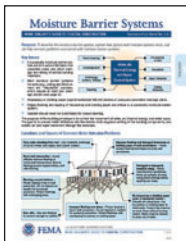
**Fact Sheet No. 1.6, Designing for Flood Levels Above the BFE** – Recommends design and construction practices that reduce the likelihood of flood damage in the event that flood levels exceed the BFE. It includes illustrations of appropriate construction practices and information on the insurance benefits of building above the BFE.



**Fact Sheet No. 1.7, Coastal Building Materials** – Provides guidance and best practices on the selection of building materials used for coastal construction. Flood, wind, corrosion, and decay resistance are discussed, including protection recommendations.



**Fact Sheet No. 1.8, Non-Traditional Building Materials and Systems** – Provides guidance on alternative building materials and techniques and their application in coastal environments. It includes discussions of Engineered Wood Products, Structural Insulated Panels, Insulating Concrete Forms, Prefabricated Shear Walls and Moment Frames, Sprayed Closed-Cell Foam Insulation, Advanced Wall Framing, and Modular Houses.



**Fact Sheet No. 1.9, Moisture Barrier Systems** – Describes the moisture barrier system, explains how typical wall moisture barrier systems work, and discusses common problems associated with moisture barrier systems.

## Category 2 – Planning



**Fact Sheet No. 2.1, How Do Siting and Design Decisions Affect the Owner's Costs?**– Discusses effects of planning, siting, and design decisions on coastal home costs. Topics include initial, operating, and long-term costs; risk determination; and the effect on costs of meeting and exceeding code and NFIP design and construction requirements.



**Fact Sheet No. 2.2, Selecting a Lot and Siting the Building**– Presents guidance concerning lot selection and building siting considerations for coastal residential buildings. Topics include factors that constrain siting decisions, coastal setback lines, common siting problems, and suggestions for builders, designers, and owners.

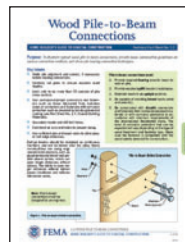
## Category 3 – Foundations



**Fact Sheet No. 3.1, Foundations in Coastal Areas**– Explains foundation design criteria and describes foundation types suitable for coastal environments. Also addresses foundations for high-elevation coastal areas (e.g., bluff areas).



**Fact Sheet No. 3.2, Pile Design and Installation**– Presents basic information about pile design and installation, including pile types, sizes and lengths, layout, installation methods, bracing, field cutting, connections, and verifying capacities.

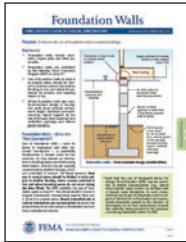


**Fact Sheet No. 3.3, Wood Pile-to-Beam Connections** – Illustrates typical wood-pile-to-beam connections; presents basic construction guidance for various connection methods, including connections for misaligned piles; and illustrates pile bracing connection techniques.



**Fact Sheet No. 3.4, Reinforced Masonry Pier Construction**— Provides an alternative to piles in V Zones and A Zones in coastal areas where soil properties preclude pile installation, but the need for an “open foundation system” still exists. Includes

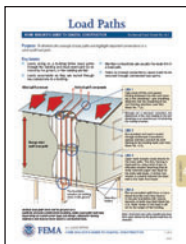
recommendations for good masonry practices in coastal environments.



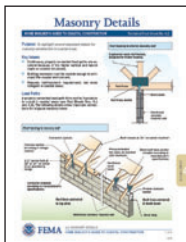
**Fact Sheet No. 3.5, Foundation Walls**— Discusses the use of foundation walls in coastal buildings. Topics include footing embedment, wall height, materials and workmanship, lateral support, flood openings and ventilation requirements, and interior grade elevations

for crawlspaces.

## Category 4 – Load Paths



**Fact Sheet No. 4.1, Load Paths**— Illustrates the concept of load paths and highlights important connections in a typical wind uplift load path.



**Fact Sheet No. 4.2, Masonry Details** – Illustrates important roof-to-wall and wall-to-foundation connection details for masonry construction in coastal areas. Topics include load paths, building materials, and reinforcement.

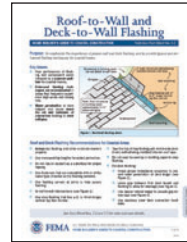


**Fact Sheet No. 4.3, Use of Connectors and Brackets**— Illustrates important building connections and the proper use of connection hardware throughout a building.

## Category 5 – Wall Systems



**Fact Sheet No. 5.1, Housewrap**— Explains the function of housewrap, examines its attributes, and addresses common problems associated with its use. Topics include housewrap vs. building paper and housewrap installation.



**Fact Sheet No. 5.2, Roof-to-Wall and Deck-to-Wall Flashing**— Emphasizes the importance of proper roof and deck flashing, and presents typical and enhanced flashing techniques for coastal homes.

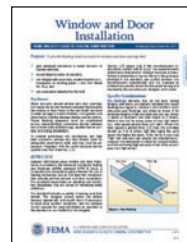


**Fact Sheet No. 5.3, Siding Installation in High-Wind Regions**— Provides basic design and installation tips for various types of siding for high-wind regions, including vinyl, wood, and fiber cement and discusses sustainable design issues.



**Fact Sheet No. 5.4, Attachment of Brick Veneer in High-Wind Regions**— Provides recommended practices for installing brick veneer that will enhance wind resistance in high wind regions. Examples of proper installations and brick veneer tie spacings are provided.

## Category 6 - Openings

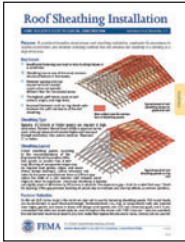


**Fact Sheet No. 6.1, Window and Door Installation**— Presents flashing detail concepts for window and door openings that provide adequate resistance to water intrusion in coastal environments, do not depend solely on sealants, are integral with secondary weather barriers (e.g., housewrap), and are adequately attached to the wall. Topics include the American Society for Testing and Materials (ASTM) Standard E 2112 and specific considerations concerning pan flashings, Exterior Insulation Finishing Systems, frame anchoring, shutters, and weatherstripping.



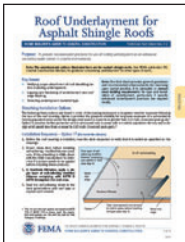
**Fact Sheet No. 6.2, Protection of Openings – Shutters and Glazing**– Presents information about the selection and installation of storm shutters and impact-resistant glazing and other types of opening protection in windborne debris regions. Shutter types addressed include temporary plywood panels; temporary manufactured panels; permanent, manual closing; and permanent, motor-driven.

## Category 7 - Roofing

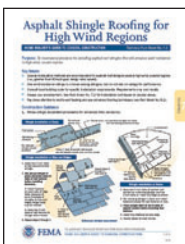


**Fact Sheet No. 7.1, Roof Sheathing Installation**– Presents information about proper roof sheathing installation and its importance in coastal construction; also discusses fastening methods that will enhance the durability of a building in a high-wind area. Topics include sheathing types and layout methods for gable-end and hip roofs, fastener selection and spacing, the treatment of ridge vents and ladder framing, and common sheathing attachment mistakes.

Topics include sheathing types and layout methods for gable-end and hip roofs, fastener selection and spacing, the treatment of ridge vents and ladder framing, and common sheathing attachment mistakes.



**Fact Sheet No. 7.2, Roof Underlayment for Asphalt Shingle Roofs**– Presents recommended practices for the use of roofing underlayment as an enhanced secondary water barrier in coastal environments. Optional installation methods are illustrated.



**Fact Sheet No. 7.3, Asphalt Shingle Roofing for High-Wind Regions**– Recommends practices for installing asphalt roof shingles that will enhance the wind resistance of roof coverings in high-wind, coastal regions. Issues include installation at hips, eaves, and ridges; shingle characteristics; weathering and durability; and wind resistance.

Issues include installation at hips, eaves, and ridges; shingle characteristics; weathering and durability; and wind resistance.



**Fact Sheet No. 7.4, Tile Roofing for High-Wind Areas**– Presents design and construction guidance for tile roofing attachment methods. Topics include uplift loads, uplift resistance, special considerations concerning tile attachment at

hips and ridges, tile installation on critical and essential buildings, and quality control.



**Fact Sheet No. 7.5, Minimizing Water Intrusion through Roof Vents in High-Wind Regions**– Describes practices for minimizing water intrusion through roof vent systems, which can lead to interior damage and mold growth in high-wind regions. Topics include soffit vents, ridge vents, gable end vents, off-ridge vents, gable rake vents, and turbines.



**Fact Sheet No. 7.6, Metal Roof Systems in High-Wind Regions**– Presents design and installation guidance for metal roofing systems that will enhance wind-resistance in high-wind regions. Discussions on sustainable design options are included.

## Category 8 - Attachments



**Fact Sheet No. 8.1, Enclosures and Breakaway Walls**– Discusses requirements and recommendations for enclosures and breakaway walls for their use below the BFE. It includes a diagram of a compliant wall system and examples of systems that have either resulted in increased damages or increased flood insurance premiums.



**Fact Sheet No. 8.2, Decks, Pools, and Accessory Structures**– Summarizes NFIP requirements, general guidelines, and recommendations concerning the construction and installation of decks, access stairs and elevators, swimming pools, and accessory buildings under or near coastal residential buildings.



**Fact Sheet No. 8.3, Protecting Utilities**– Identifies the special considerations that must be made when installing utility equipment, such as fuel, sewage, and water/sewage lines in a coastal home, and presents recommendations for utility protection.

## Category 9 - Repairs



**Fact Sheet No. 9.1, Repairs, Remodeling, Additions, and Retrofitting - Flood**– Outlines NFIP requirements for repairs, remodeling, and additions, and discusses opportunities for retrofitting in coastal flood hazard areas. Also presents recommendations for exceeding the minimum NFIP requirements. Definitions of “substantial damage” and “substantial improvement” are included.



**Fact Sheet No. 9.2, Repairs, Remodeling, Additions, and Retrofitting - Wind**– Outlines requirements and makes “best practice” recommendations for repairs, remodeling, and additions, and discusses opportunities for retrofitting in coastal high wind areas.

## Category G - Guide



**Fact Sheet No. G.1– Technical Fact Sheet Guide**



**Fact Sheet No. G.2, References and Resources**– Lists references that provide information relevant to topics covered by the *Home Builder’s Guide to Coastal Construction* technical fact sheets.

## FEMA P-499 Home Builder’s Guide to Coastal Construction– 2005 to 2010 Crosswalk

Category	Category Code	Sheet	Title	2005 Edition Fact Sheet No.
Guide	G	1	Technical Fact Sheet Guide	
General	1	1	Coastal Building Success and Failures	1
General	1	2	Summary of Coastal Construction Requirements and Recommendations for Flood Effects	2
General	1	3	Using a Digital Flood Insurance Rate Map (DFIRM)	3
General	1	4	Lowest Floor Elevation	4
General	1	5	V Zone Design Certification	5
General	1	6	Designing for Flood Levels Above the BFE	New
General	1	7	Coastal Building Materials	8
General	1	8	Non-Traditional Building Materials and Systems	New
General	1	9	Moisture Barrier Systems	9
Planning	2	1	How Do Siting and Design Decisions Affect the Owner’s Costs?	6
Planning	2	2	Selecting a Lot and Siting the Building	7
Foundations	3	1	Foundations in Coastal Areas	11
Foundations	3	2	Pile Design and Installation	12
Foundations	3	3	Wood Pile-to-Beam Connections	13
Foundations	3	4	Reinforced Masonry Pier Construction	14
Foundations	3	5	Foundation Walls	15

G.1: COASTAL CONSTRUCTION FACT SHEET SERIES

Category	Category Code	Sheet	Title	2005 Edition Fact Sheet No.
Load Paths	4	1	Load Paths	10
Load Paths	4	2	Masonry Details	16
Load Paths	4	3	Use of Connectors and Brackets	17
Wall Systems	5	1	Housewrap	23
Wall Systems	5	2	Roof-to-Wall and Deck-to-Wall Flashing	24
Wall Systems	5	3	Siding Installation in High-Wind Regions	25
Wall Systems	5	4	Attachment of Brick Veneer in High-Wind Regions	New
Openings	6	1	Window and Door Installation	22
Openings	6	2	Protection of Openings - Shutters and Glazing	26
Roofing	7	1	Roof Sheathing Installation	18
Roofing	7	2	Roof Underlayment for Asphalt Shingle Roofs	19
Roofing	7	3	Asphalt Shingle Roofing for High-Wind Regions	20
Roofing	7	4	Tile Roofing for High-Wind Areas	21
Roofing	7	5	Minimizing Water Intrusion through Roof Vents in High-Wind Regions	New
Roofing	7	6	Metal Roof Systems in High-Wind Regions	New
Attachments	8	1	Enclosures and Breakaway Walls	27
Attachments	8	2	Decks, Pools, and Accessory Structures	28
Attachments	8	3	Protecting Utilities	29
Repairs	9	1	Repairs, Remodeling, Additions and Retrofitting - Flood	30
Repairs	9	2	Repairs, Remodeling, Additions and Retrofitting - Wind	30
Guide	G	2	References and Resources	31

Developed in association with the National Association of Home Builders Research Center





# Coastal Building Successes and Failures

**Purpose:** *To discuss how coastal construction requirements are different from those for inland construction. To discuss the characteristics that make for a successful coastal building.*

## Is Coastal Construction That Different From Inland Construction?

The short answer is **yes**, building in a coastal environment is different from building in an inland area:

- **Flood levels, velocities, and wave** action in coastal areas tend to make coastal flooding more damaging than inland flooding.
- Coastal **erosion** can undermine buildings and destroy land, roads, utilities, and infrastructure.
- **Wind speeds** are typically higher in coastal areas and require stronger engineered building connections and more closely spaced nailing of building sheathing, siding, and roof shingles.
- **Wind-driven rain, corrosion, and decay** are frequent concerns in coastal areas.

In general, homes in coastal areas must be designed and built to withstand **higher loads** and **more extreme conditions**. Homes in coastal areas will require **more maintenance** and upkeep. Because of their exposure to higher loads and extreme conditions, homes in coastal areas will cost more to design, construct, maintain, repair, and insure.

## Building Success

In order for a coastal building to be considered a "success," four things must occur:

- The building must be designed to withstand coastal forces and conditions.
- The building must be constructed as designed.
- The building must be sited so that erosion does not undermine the building or render it uninhabitable.
- The building must be maintained/repaired.

A well-built but poorly sited building can be undermined and will not be a success (see Figure 1). Even if a building is set back or situated farther from the coastline, it will not perform well (i.e., will not be a success) if it is incapable of resisting high winds and other hazards that occur at the site (see Figure 2).



Figure 1. Well-built but poorly sited building.



Figure 2. Well-sited building that still sustained damage.



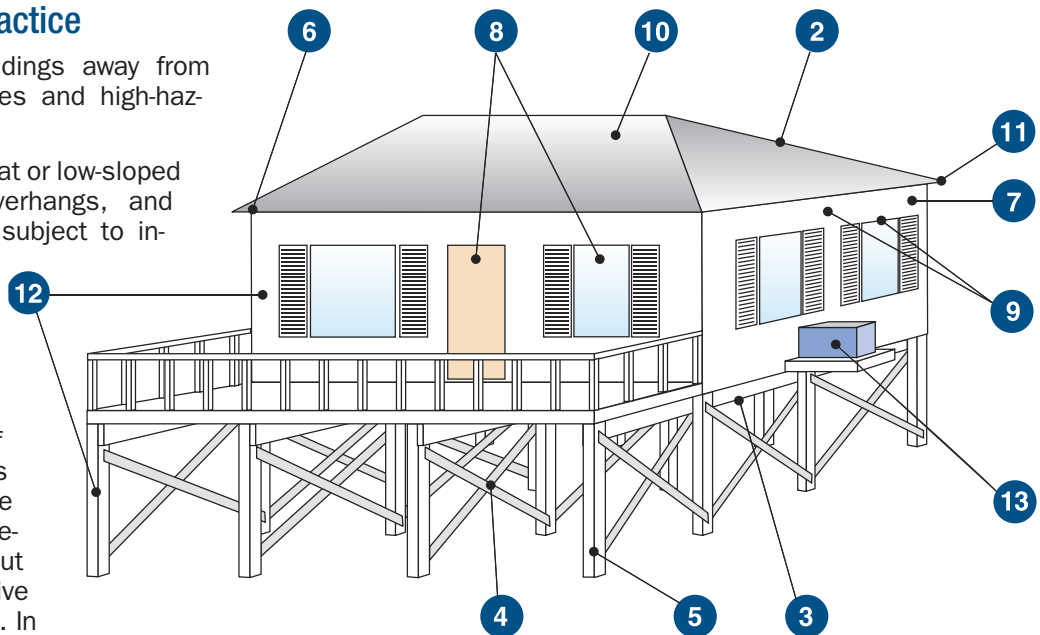
## What Should Owners and Home Builders Expect From a “Successful” Coastal Building?

In coastal areas, a building can be considered a success only if it is capable of resisting damage from coastal hazards and coastal processes over a period of decades. This statement does not imply that a coastal residential building will remain undamaged over its intended lifetime. It means that the impacts of a design-level flood, storm, wind, or erosion event (or series of lesser events with combined impacts equivalent to a design event) will be limited to the following:

- The building **foundation** must remain intact and functional.
- The **envelope** (walls, openings, roof, and lowest floor) must remain structurally sound and capable of minimizing penetration by wind, rain, and debris.
- The **lowest floor** elevation must be sufficient to prevent floodwaters from entering the elevated building envelope during the design event.
- The **utility connections** (e.g., electricity, water, sewer, natural gas) must remain intact or be restored easily.
- The building must be **accessible** and **usable** following a design-level event.
- Any damage to **enclosures** below the Design Flood Elevation (DFE)\* must not result in damage to the foundation, the utility connections, or the elevated portion of the building.

### Recommended Practice

- 1 **Siting**— Site buildings away from eroding shorelines and high-hazard areas.
- 2 **Building Form**— Flat or low-sloped porch roofs, overhangs, and gable ends are subject to increased uplift in high winds. Buildings that are both tall and narrow are subject to overturning. Each of these problems can be overcome through the design process, but each must receive special attention. In the design process, choose moderate-sloped hip roofs (4/12 to 6/12) if possible.
- 3 **Lowest Floor Elevation**— Elevate above the DFE the bottom of the lowest horizontal structural member supporting the lowest floor. Add “freeboard” to reduce damage and lower flood insurance premiums.
- 4 **Free of Obstructions**— Use an open foundation. Do not obstruct the area below the elevated portion of the building. Avoid or minimize the use of breakaway walls. Do not install utilities



or finish enclosed areas below the DFE (owners tend to convert these areas to habitable uses, which is prohibited under the National Flood Insurance Program and will lead to additional flood damage and economic loss).

- 5 **Foundation**— Make sure the foundation is deep enough to resist the effects of scour and erosion; strong enough to resist wave, current, flood, and debris forces; and capable of

transferring wind and seismic forces on upper stories to the ground.

**6 Connections**– Key connections include roof sheathing, roof-to-wall, wall-to-wall, and walls-to-foundation. Be sure these connections are constructed according to the design. Bolts, screws, and ring-shanked nails are common requirements. Standard connection details and nailing should be identified on the plans.

**7 Exterior Walls**– Use structural sheathing in high-wind areas for increased wall strength. Use tighter nailing schedules for attaching sheathing. Care should be taken not to over-drive pneumatically driven nails. This can result in loss of shear capacity in shearwalls.

**8 Windows and Glass Doors**– In high-wind areas, use windows and doors capable of withstanding increased wind pressures. In windborne debris areas, use impact-resistant glazing or shutters.

**9 Flashing and Weather Barriers**– Use stronger connections and improved flashing for roofs, walls, doors, and windows and other openings. Properly installed secondary moisture barriers, such as housewrap or building paper, can reduce water intrusion from wind-driven rain.

**10 Roof**– In high-wind areas, select appropriate roof coverings and pay close attention to detailing. Avoid roof tiles in hurricane-prone areas.

**11 Porch Roofs and Roof Overhangs**– Design and tie down porch roofs and roof overhangs to resist uplift forces.

**12 Building Materials**– Use flood-resistant materials below the DFE. All exposed materials should be moisture- and decay-resistant. Metals should have enhanced corrosion protection.

**13 Mechanical and Utilities**– Electrical boxes, HVAC equipment, and other equipment should be elevated to avoid flood damage and strategically located to avoid wind damage. Utility lines and runs should be installed to minimize potential flood damage.

**14 Quality Control**– Construction inspections and quality control are essential for building success. Even “minor” construction errors and defects can lead to major damage during high-wind or flood events. Keep this in mind when inspecting construction or assessing yearly maintenance needs.

Recommended practice and guidance concerning the topics listed above can be found in the documents referenced in these fact sheets and in many trade publications (e.g., *The Journal of Light Construction*, <http://www.jlconline.com>).

### Will the Likelihood of Success (Building Performance) Be Improved by Exceeding Minimum Requirements?

States and communities enforce regulatory requirements that determine where and how buildings may be sited, designed, and constructed. There are often economic benefits to exceeding the enforced requirements (see box). Designers and home builders can help owners evaluate their options and make informed decisions about whether to exceed these requirements.

#### Benefits of Exceeding Minimum Requirements

- Reduced building damage during coastal storm events
- Reduced building maintenance
- Longer building lifetime
- Reduced insurance premiums\*
- Increased reputation of builder

\* Note: Flood insurance premiums can be reduced up to 60 percent by exceeding minimum siting, design, and construction practices. See the V Zone Risk Factor Rating Form in FEMA's *Flood Insurance Manual* (<http://www.fema.gov/nfip/manual.shtm>).

Developed in association with the National Association of Home Builders Research Center





# Summary of Coastal Construction Requirements and Recommendations

**Purpose:** *To summarize recommendations for exceeding National Flood Insurance Program (NFIP) regulatory requirements concerning coastal construction.*




## Key Issues

- *New construction\** in coastal flood hazard areas (V Zone and A Zone) should be designed using the engineering standards (ASCE 24 and ASCE 7) or the International Residential Code (IRC), as applicable. Best practices must exceed the minimum NFIP requirements and must meet, or exceed, all community zoning and building code requirements. *Repairs, remodeling, and additions* must always meet NFIP and building code requirements for the part of the structure impacted. Should these costs exceed 50 percent of the fair market value of the structure, the entire building must be brought to local floodplain management and building code compliance.
- Engineering standards ASCE 24-05 and ASCE 7-10 are *more stringent in V Zones than in A Zones*, to protect against the increased flood, wave, flood-borne debris, and erosion hazards typical of V Zones.
- **For added protection, it is strongly recommended that buildings in flood zones that are subject to breaking waves between 1.5 and 3 feet as well as erosion and scour be designed and constructed to V Zone standards.** These coastal areas, mapped as A Zones, may be subject to damaging waves and erosion and are often referred to as “Coastal A Zones.” Buildings in these areas are typically constructed to the minimum NFIP A Zone requirements and have at least a 1-percent-annual-chance of sustaining major damage or being destroyed. This regulatory standard is known as the *base flood*.
- Buildings constructed to minimum NFIP A Zone standards and subject solely to shallow flooding (i.e., not subject to breaking waves greater than 1.5 feet or erosion) are still subject to flood damage and should be built with a first floor elevation above the BFE (usually at least one foot or greater), which is referred to as “freeboard.”
- Following the recommendations in the following table will result in less damage to the building and may reduce flood insurance premiums (see the V Zone Risk Factor Rating Form in FEMA’s *Flood Insurance Manual* (<http://www.fema.gov/nfip/manual.shtm>)).




\* For floodplain management purposes, **new construction** refers to structures for which construction began on or after the effective date of adoption of the community’s floodplain management ordinance. Substantial improvements, repairs of substantially damaged buildings, and some enclosures must meet the same floodplain management ordinance and building code requirements as new construction where such ordinances and codes have been adopted by the community.

The following table summarizes NFIP regulatory requirements and recommendations for exceeding those requirements for both (1) new construction and (2) repairs, remodeling, and additions.






Coastal Construction Requirements and Recommendations				
	V Zone 	Coastal A Zone 	A Zone 	Additional Resources
<b>Foundation</b>				
<b>Structural Fill</b> NFIP 60.3(e)(6)	Prohibited	<b>Requirement:</b> Compaction where used; protect against scour and erosion.	<b>Requirement:</b> Compaction where used; protect against scour and erosion.	IBC: 1804.4, App. G 401.1, App. G 401.2 IRC: R322.3.2 ASCE: ASCE 24 Sec. 2.4 Other: FEMA TB #5
<b>Solid Foundation Walls [see Fact Sheet Nos. 3.1, 3.5]</b> NFIP 60.3(c)(3)	Prohibited	<b>Requirement:</b> Flood vents must be installed to equalize pressures (see Fact Sheets Nos. 3.5 and 8.1). <b>Recommendation:</b> An open foundation system should be used.	<b>Requirement:</b> Where used, the walls must allow floodwaters to pass between or through the walls using flood openings (see Fact Sheets Nos. 3.5 and 8.1).	IBC: 1612.5.1 IRC: R322.2.3 ASCE: ASCE 24 Sec. 2.5, ASCE 7 Sec. 5.4.4.2 Other: FEMA TB #5, FEMA 550
<b>Open Foundation [see Fact Sheet No. 3.1]</b> NFIP 60.3(e)(5) and 60.3(c)(5)	<b>Recommendation:</b> Site new construction landward of the long-term erosion setback and landward of the area subject to erosion during the 1% coastal flood event. <b>Requirement:</b> All new construction shall be landward of the reach of the mean high tide; alteration of sand dunes and mangrove stands that increases the potential of flood damage is prohibited.	<b>Recommendation:</b> Open foundations are recommended in Coastal A Zones.	<b>Recommendation:</b> Open foundations are recommended in A Zones.	IBC: 1803.5.5 IRC: R322.3.3 ASCE: ASCE 7 Sec. 5.4.4.1, ASCE 24 Sec 4.5.5 Other: FEMA TB #5
<b>Lowest Floor Elevation (not in a V Zone) [see Fact Sheet No. 1.5]</b> NFIP 60.3(c)	Not Applicable	<b>Recommendation:</b> Elevate the bottom of the lowest horizontal structural member at, or above, BFE. <b>Requirement:</b> Top of floor must be at or above BFE.	<b>Requirement:</b> Top of floor must be at or above BFE.	IBC: 1603.1.7, 1612.5 IRC: R105.3.1.1, R322.2.1, R322.1.5 ASCE: ASCE 24 Sec. 1.5.2, ASCE 24 Sec. 2.5, ASCE 24 Ch. 5, ASCE 24 Ch. 7 Other: FEMA TB #5
<b>Bottom Lowest Horizontal Structural Member [see Fact Sheet No. 1.4]</b> NFIP 60.3(e)(4)	<b>Requirement:</b> Bottom of the lowest horizontal structural member of the first floor must be at, or above, the BFE (see Fact Sheet No. 1.5).	<b>Recommendation:</b> Follow the V Zone building elevation requirement.	<b>Recommendation:</b> The minimum recommendation is to follow the Coastal A Zone requirements. Users should consider following V Zone recommendations for the lowest horizontal structural member elevation to further minimize the risk of flood damage.	IBC: 1603.1.7, 1605.2.2, 1605.3.1.2, 1612.4, 1612.5.2 IRC: R322.3.2 ASCE: ASCE 24 Sec. 4.4, ASCE 24 Sec. 2.5, ASCE 24 Ch. 5 Other: FEMA 55, FEMA TB #8, FEMA TB #5

1.2: SUMMARY OF COASTAL CONSTRUCTION REQUIREMENTS AND RECOMMENDATIONS

Coastal Construction Requirements and Recommendations			
V Zone 	Coastal A Zone 	A Zone 	Additional Resources

Foundation				
<b>Orientation of Lowest Horizontal Structural Member</b>	<p><b>Requirement:</b> Elevate the bottom of the lowest horizontal structural member at, or above, BFE.</p>	<p><b>Recommendation:</b> If the orientation of the lowest horizontal structural member is parallel to the expected direction of waves, elevate the bottom of the member to or above BFE; If the orientation of the lowest horizontal structural member is perpendicular to the expected direction of waves, elevate the bottom of the member to BFE plus one foot. Diagonal bracing for decks, stairways, balconies and other attached structures should also be elevated at, or above, the BFE.</p>	<p><b>Recommendation:</b> Follow the Coastal A Zone recommendation.</p>	<p><b>IBC:</b> see ASCE 24 <b>IRC:</b> R322.3.2 <b>ASCE:</b> ASCE 24 Sec 4.4 <b>Other:</b> FEMA TB #5</p>
<b>Freeboard [see Fact Sheet Nos. 1.1, 1.4]</b>	<p><b>Requirement:</b> No NFIP requirement, but freeboard is required by IRC and ASCE.</p>	<p><b>Recommendation:</b> Freeboard is recommended in Coastal A Zones.  <b>Note:</b> Per ASCE 24-05 one foot of freeboard required for Risk Category II structures.</p>	<p><b>Recommendation:</b> Freeboard is recommended in A Zones.  <b>Note:</b> One foot above BFE is required per IRC R322.2.1 Item #2 for Coastal A Zones.</p>	<p><b>IBC:</b> see ASCE 24 <b>IRC:</b> R322.2.1, R322.3.2 <b>ASCE:</b> ASCE 24 Sec. 2.3</p>
<b>Enclosures Below the BFE (not in a V Zone)</b>	<b>Not Applicable</b>	<p><b>Recommendation:</b> If an enclosure is constructed, use breakaway walls, open lattice, or screening (as required in V Zones).  <b>Requirement:</b> If an area is fully enclosed, the enclosure walls must be equipped with openings to equalize hydrostatic pressure; the size, location, and covering of openings governed by regulatory requirements.</p>	<p><b>Recommendation:</b> If an enclosure is constructed, use breakaway walls, open lattice, or screening (as required in V Zones).  <b>Requirement:</b> If an area is fully enclosed, the enclosure walls must be equipped with openings to equalize hydrostatic pressure; the size, location, and covering of openings governed by regulatory requirements.</p>	<p><b>IBC:</b> 1203.3.2, 1403.5, 1612.4, 1612.5.1 <b>IRC:</b> R322.2.2, R408.7 <b>ASCE:</b> ASCE 24 Sec. 2.6, ASCE 24 Sec 4.6 <b>Other:</b> FEMA TB #1</p>
<b>Enclosures Below the BFE (not in V Zones) [see Fact Sheet No. 8.1]  NFIP 60.3(c)(5)</b>	<p><b>Prohibited,</b> except for breakaway walls, open wood lattice, and screening.</p>	<b>Not Applicable</b>	<b>Not Applicable</b>	<p><b>IBC:</b> 1403.5, 1403.6, 1612.4, 1612.5.2 <b>IRC:</b> R322.3.2, R322.3.4, R322.3.5 <b>ASCE:</b> ASCE 24 Sec. 4.6, ASCE 7 Sec. C5.3.3 <b>Other:</b> FEMA 55, FEMA TB #5, FEMA TB #9</p>

Coastal Construction Requirements and Recommendations				
	V Zone 	Coastal A Zone 	A Zone 	Additional Resources
<b>Foundation</b>				
<b>Non Structural Fill</b>	<b>Requirement:</b> Allowed for minor landscaping and site drainage as long as the fill does not interfere with free passage of flood waters and debris beneath the building, or cause changes in flow direction during coastal storms that could result in damage to buildings.	<b>Recommendation:</b> Follow the V Zone fill requirement.	<b>Recommendation:</b> Follow the V Zone fill requirement.	<b>IBC:</b> 803.11.1 <b>IRC:</b> R322.14.2, R322.3.2 <b>ASCE:</b> ASCE 24 Sec 1.5.4, 45.4 <b>Other:</b> FEMA TB #5
<b>Use of Space Below BFE</b> [see Fact Sheet No. 8.1]	<b>Requirement:</b> Allowed only for parking, building access, and storage	<b>Requirement:</b> Allowed only for parking, building access, and storage	<b>Requirement:</b> Allowed only for parking, building access, and storage	<b>IBC:</b> 1107.7.5, G105.7 (5), 801.5, G103.5, G103.8 <b>IRC:</b> R309.3, R322.1, R322.1.2, R322.1.3, R322.1.4, R322.1.4.1, R322.2.1, R322.2.2, R322.3.2, R322.3.5 <b>ASCE:</b> ASCE 24 1.5.2, 2.6, 2.6.1, 2.6.2.1, 2.6.2.2, 4.6, 4.6.1, 4.6.2
<b>Utilities</b>				
<b>Sanitary Sewer</b> NFIP 60.3(a)(6)(i) and 60.3(a)(6)(ii)				<b>IBC:</b> 1403.6, App. G 401.3 <b>IRC:</b> R322.1.7, R P2602.2, R P3001.3, R P3101.5 <b>ASCE:</b> ASCE 24 Sec. 7.3.4 <b>Other:</b> FEMA 348, FEMA TB #4
<b>Utilities</b> [see Fact Sheet No. 8.3] NFIP 60.3(a)(3) (iv)	<b>Requirement:</b> Must be designed, located, and elevated to prevent flood waters from entering and accumulating in components during flooding. Utility lines must not be installed or stubbed out in enclosures below BFE unless flood proofed to the extent practicable.	<b>Requirement:</b> Electrical, heating, ventilation, plumbing, and air-conditioning equipment and other service facilities to be designed and/or located as to prevent water from entering or accumulating within the components during periods of flooding. <b>Recommendation:</b> Follow the V Zone utility recommendation	<b>Requirement:</b> Electrical, heating, ventilation, plumbing, and air-conditioning equipment and other service facilities to be designed and/or located as to prevent water from entering or accumulating within the components during periods of flooding.	<b>IBC:</b> 1403.6, 1612.4, App. G 701 <b>IRC:</b> R322.1.6, IFGC 301.11, R G2404.7, R P2601.3, R P2602.2, R M1301.1.1, R M1401.5, R M1601.4.9, R M1701.2, R M2001.4, R M2201.6 <b>ASCE:</b> ASCE 24 Ch. 7 <b>Other:</b> FEMA 348, FEMA TB #4
<b>Certification</b>				
<b>Permits</b> NFIP 60.3(b)(1)	<b>Requirement:</b> V Zone certificate, Breakaway Wall certificate, and Elevation Certificate.	<b>Requirement:</b> Elevation Certificate.	<b>Requirement:</b> Elevation Certificate.	<b>IBC:</b> App. G 101.3, App. G 103, App. G 104 <b>IRC:</b> R104.2, R105, App. E, App. J <b>ASCE:</b> ASCE 24 Sec. 4.6, ASCE 7 Sec. C5.3.3 <b>Other:</b> FEMA EMI IS-9



## Coastal Construction Requirements and Recommendations

V Zone



Coastal A Zone






A Zone



Additional Resources

### Certification

<p><b>Elevation</b> NFIP 60.3(b)(5)(i) and 60.3(e)(2)</p>	<p><b>Requirement:</b> The lowest horizontal structural member must be at, or above, BFE; electrical, heating, ventilation, plumbing, and air-conditioning equipment and other service facilities (including ductwork) must be designed and/or located so as to prevent water from entering or accumulating within the components during flooding (see Fact Sheet Nos. 1.4, 1.5, 8.3)</p>	<p><b>Recommendation:</b> Follow the V Zone building elevation requirement.</p> <p><b>Requirement:</b> Top of lowest floor must be at, or above, BFE; electrical heating, ventilation, plumbing, and air conditioning equipment and other service facilities (including ductwork) must be designed and/or located so as to prevent water from entering or accumulating within the components during flooding (see Fact Sheet Nos. 1.4 8.3)</p>	<p><b>Recommendation:</b> The minimum recommendation is to follow the Coastal A Zone requirements. Users should consider following V Zone recommendations for the lowest horizontal structural member elevation to further minimize the risk of flood damage.</p> <p><b>Requirement:</b> Top of the lowest floor must be at, or above, BFE; electrical heating, ventilation, plumbing, and air conditioning equipment and other service facilities (including ductwork) must be designed and/or located so as to prevent water from entering or accumulating within the components during flooding (see Fact Sheet Nos. 1.4, 8.3)</p>	<p><b>IBC:</b> 110.3.3, 1603.1.7, 1612.5 <b>IRC:</b> R106.1.3, R322.1.2, R322.1.5, R322.2.1 <b>ASCE:</b> ASCE 24 Sec. 1.5.1, 1.5.2, 4.4</p>
<p><b>Structure</b></p>	<p><b>Requirement:</b> Registered engineer or architect must certify that the design and methods of construction are in accordance with an accepted standard of practice for meeting design requirements described under General Requirement (see Fact Sheet No. 1.5)</p>	<p><b>Recommendation:</b> Follow the V Zone requirement.</p>	<p><b>Recommendation:</b> Follow the V Zone requirement.</p>	<p><b>IBC:</b> 1604.1, 1604.2, 1604.3 <b>IRC:</b> R301.1, R301.1.3, R301.2 <b>ASCE:</b> ASCE 7 Sec. 1.3.1.3.3</p>

Coastal Construction Requirements and Recommendations				
	V Zone 	Coastal A Zone 	A Zone 	Additional Resources
<b>Certification</b>				
<b>Breakaway Walls</b> [see Fact Sheet Nos. 1.5, 8.1] (also see Enclosures Below BFE) NFIP 60.3(e)(5)	<b>Requirement:</b> Walls must be designed to break free under larger of the following allowable stress design loads: (1) design wind load, (2) design seismic load, or (3) 10 psf, acting perpendicular to the plane of the wall; if loading intended to cause collapse exceeds 20 psf using allowable stress design, the breakaway wall design shall be certified; when certification is required, a registered engineer or architect must certify that the walls will collapse under a water load associated with the Base Flood and that the elevated portion of the building and its foundation will not be subject to collapse, displacement, or lateral movement under simultaneous wind and water loads.	<b>Recommendation:</b> Breakaway walls are recommended with an open foundation in lieu of solid walls; if breakaway walls are used and enclose an area, flood openings are required (see Fact Sheet Nos. 3.1, 3.5).		<b>IBC:</b> 1612.5 (2.3) <b>IRC:</b> R322.3.4 <b>ASCE:</b> ASCE 24 Sec. 4.6.1, 4.6.2, 2.6.1.1, ASCE 7 Sec. 5.3.3 <b>Other:</b> FEMA TB #5, FEMA TB #9
<b>Openings in Below-BFE Walls</b> [see Fact Sheet Nos. 3.1, 3.5] (also see Enclosures Below BFE) NFIP 60.3(c)(5)	<b>Not Applicable</b>	<b>Requirement:</b> Unless the number and size of the openings meet regulatory requirements, a registered engineer or architect must certify that the openings are designed to automatically equalize hydrostatic forces on the walls by allowing automatic entry and exit of flood waters.	<b>Requirement:</b> Unless the number and size of the openings meet regulatory requirements, a registered engineer or architect must certify that the openings are designed to automatically equalize hydrostatic forces on the walls by allowing automatic entry and exit of flood waters.	<b>IBC:</b> 1203.4.12, G1001.4 <b>IRC:</b> R322.2.2 <b>ASCE:</b> ASCE 24 Sec. 2.6.1, 2.6.2.1, 2.6.2.2 <b>Other:</b> FEMA TB #1
<b>Repairs, Remodeling, and Additions [See Fact Sheet No. 9.1]</b>				
<b>Substantial Improvements and Repairs of Substantial Damage</b> NFIP 60.3(e)(5) and 60.3(c)(5)	<b>Requirement:</b> Must meet current NFIP requirements concerning new construction in V Zones except for siting landward of mean high tide (see Fact Sheet Nos. 1.4, 1.5, 2.2, 3.1, 3.5, 8.1, 8.3).	<b>Recommendation:</b> Follow the V Zone requirement for building elevation and open foundations. <b>Requirement:</b> Must meet current NFIP requirements concerning new construction in A Zones (see Fact Sheet Nos. 1.4, 3.1, 3.5, 8.1, 8.3).	<b>Recommendation:</b> Elevate bottom of lowest horizontal structural member to or above BFE. <b>Requirement:</b> Must meet current NFIP requirements concerning new construction in A Zones (see Fact Sheet Nos. 1.1, 3.1, 3.5, 8.1, 8.3)	<b>IBC:</b> 1612.1, 1612.2, 3403.2, 3404.2, 3405.2, 3405.3, 3405.4 <b>IRC:</b> R322.1.6, R322.3.1 <b>ASCE:</b> ASCE 24 Sec. 4.3, ASCE 7 Sec. 1.6 <b>Other:</b> FEMA P-758

## Coastal Construction Requirements and Recommendations

V Zone



Coastal A Zone






A Zone



Additional Resources

### Repairs, Remodeling, and Additions [See Fact Sheet No. 9.1]

<p><b>Lateral Additions That Constitute Substantial Improvement</b> NFIP 60.3(e)(5)</p>	<p><b>Requirement:</b> Both the addition and the existing building must meet current NFIP requirements concerning new construction in V Zones (see Fact Sheet Nos. 1.4, 1.5, 2.2, 3.1, 3.5, 8.1, 8.3).</p>	<p><b>Recommendation:</b> Follow V Zone requirement for building elevation and open foundations for the addition and the existing building.</p> <p><b>Requirement:</b> Only additions must meet current NFIP requirements concerning new construction in A Zones (see Fact Sheet Nos. 1.4, 1.5, 3.1, 3.5, 8.1, 8.3), provided the existing building is not subject to any work other than cutting an entrance in a common wall and connecting the existing building to the addition; if any other work is done to the existing building it too must meet current NFIP requirements for new construction in A Zones.</p>	<p><b>Recommendation:</b> Elevate bottom of lowest structural member of the addition to or above BFE (same for the existing building if it is elevated).</p> <p><b>Requirement:</b> Only additions must meet current NFIP requirements concerning new construction in A Zones (see Fact Sheet Nos. 1.4, 2.2, 3.1, 3.5, 8.1, 8.3), provided the existing building is not subject to any work other than cutting an entrance in a common wall and connecting the existing building to the addition; if any other work is done to the existing building it too must meet current NFIP requirements for new construction in A Zones.</p>	<p><b>IBC:</b> 3403.2, 3412.2.3, 3405.3 <b>IRC:</b> R322.3.1 <b>ASCE:</b> ASCE 7 Sec. 1.6 <b>Other:</b> FEMA TB #1, FEMA TB #5, FEMA TB #9, FEMA 550</p>
<p><b>Lateral Additions That Do Not Constitute Substantial Improvement</b> NFIP 60.3(e)(5) and 60.3(c)(5)</p>	<p><b>Recommendation:</b> Make addition compliant with current NFIP requirements for V Zone construction.</p> <p><b>Requirements:</b> Post-FIRM existing building – the addition must meet NFIP requirements in effect at time the building was originally constructed. Pre-FIRM existing building – NFIP requirements concerning new construction are not triggered (see Fact Sheet Nos. 1d, 1e, 2b, 3a, 3e, 8a, 8c)</p>	<p><b>Recommendation:</b> Follow V Zone requirement for building elevation and open foundations for the addition and the existing building.</p> <p><b>Requirements:</b> Post-FIRM existing building – the addition must meet NFIP requirements in effect at the time the building was originally constructed (see Fact Sheet Nos. 1d, 1e, 2b, 3a, 3e, 8a, 8c). Pre-FIRM existing building -- NFIP requirements concerning new construction are not triggered.</p>	<p><b>Recommendation:</b> Elevate bottom of lowest horizontal structural member to or above BFE (same for existing building if it is elevated) (see Fact Sheet No. 1d)</p> <p><b>Requirements:</b> Post-FIRM existing building – the addition must meet NFIP requirements in effect at the time the building was originally constructed (see Fact Sheet Nos. 1d, 1e, 2b, 3a, 3e, 8a, 8c). Pre-FIRM existing building -- NFIP requirements concerning new construction are not triggered.</p>	<p><b>BC:</b> 3403.2, 3412.2.3, 3405.3 <b>IRC:</b> R322.3.1 <b>ASCE:</b> ASCE 7 Sec. 1.6 <b>Other:</b> FEMA TB #1, FEMA TB #5, FEMA TB #9, FEMA 550</p>

Coastal Construction Requirements and Recommendations				
	V Zone 	Coastal A Zone 	A Zone 	Additional Resources
Repairs, Remodeling, and Additions [See Fact Sheet No. 9.1]				
<b>Vertical Additions That Constitute Substantial Improvement</b>  <b>NFIP 60.3(e)(5) and 60.3(c)(5)</b>	<b>Requirement:</b> Entire building must meet current NFIP requirements concerning new construction in V Zones (see Fact Sheet Nos. 1d, 1e, 2b, 3a, 3e, 8a, 8c).	<b>Recommendation:</b> Follow V Zone requirements for building elevation and open foundations.  <b>Requirement:</b> Entire building must meet current NFIP requirements concerning new construction in A Zones (see Fact Sheet Nos. 1d, 1e, 2b, 3a, 3e, 8a, 8c).	<b>Recommendation:</b> Elevate bottom of lowest horizontal structural member to or above BFE (same for existing building if it is elevated) (see Fact Sheet No. 1d).  <b>Requirements:</b> Post-FIRM existing building – the addition must meet NFIP requirements in effect at the time the building was originally constructed (see Fact Sheet Nos. 1d, 1e, 2b, 3a, 3e, 8a, 8c). Pre-FIRM existing building -- NFIP requirements concerning new construction are not triggered.	<b>IBC:</b> 3405.3.1, 3405.4, 3405.5 <b>IRC:</b> N/A <b>ASCE:</b> N/A
<b>Vertical Additions That Do Not Constitute Substantial Improvement</b>  <b>NFIP 60.3(e)(5) and 60.3(c)(5)</b>	<b>Recommendation:</b> Make the addition compliant with current NFIP requirements for V Zone construction.  <b>Requirements:</b> Post-FIRM existing building – the addition must meet NFIP requirements in effect at the time the building was originally constructed. Pre-FIRM existing building -- NFIP requirements concerning new construction are not triggered (see Fact Sheet Nos. 1.4, 1.5, 2.2, 3.1, 3.5, 8.1, 8.3).	<b>Recommendation:</b> Follow the V Zone requirement for building elevation and open foundations for the existing building.  <b>Requirements:</b> Post-FIRM existing building – the addition must meet NFIP requirements in effect at the time the building was originally constructed (see Fact Sheet Nos. 1.4, 1.5, 2.2, 3.1, 3.5, 8.1, 8.3). Pre-FIRM existing building -- NFIP requirements concerning new construction are not triggered.	<b>Recommendation:</b> Elevate bottom of lowest horizontal structural member at, or above, BFE (same for the existing building if it is elevated) (see Fact Sheet No. 1.4).  <b>Requirements:</b> Post-FIRM existing building – the addition must meet NFIP requirements in effect at the time the building was originally constructed (see Fact Sheet Nos. 1.4, 1.5, 2.2, 3.1, 3.5, 8.1, 8.3). Pre-FIRM existing building -- NFIP requirements concerning new construction are not triggered.	<b>IBC:</b> 3405.3.1, 3405.4, 3405.5 <b>IRC:</b> N/A <b>ASCE:</b> N/A

## Coastal Construction Requirements and Recommendations

V Zone



Coastal A Zone






A Zone



Additional Resources

### Repairs, Remodeling, and Additions [See Fact Sheet No. 9.1]

<p><b>Elevating on New Foundation</b></p> <p>NFIP 60.3(e)(5) and 60.3(c)(5)</p>	<p><b>Requirement:</b> New foundation must meet current NFIP requirements concerning new construction in V Zones; the building must be properly connected and anchored to the new foundation.</p> <p><b>Note:</b> Repairing a foundation that does not constitute a substantial improvement does not require current compliance, but compliance to the year of construction.</p>	<p><b>Recommendation:</b> Follow the V Zone requirement for building elevation and open foundations.</p> <p><b>Requirement:</b> New foundation must meet current NFIP requirements concerning new construction in A Zones; the building must be properly connected and anchored to the new foundation.</p>	<p><b>Recommendation:</b> Elevated bottom of lowest horizontal structural member to or above BFE (see Fact Sheet No. 1d).</p> <p><b>Requirement:</b> New foundation must meet current NFIP requirements concerning new construction in A Zones; the building must be properly connected and anchored to the new foundation.</p>	<p><b>IBC:</b> 1808.1, 1808.2, 1808.3, 1808.6, 1808.6.1</p> <p><b>IRC:</b> R401.1, R401.2, R401.3, R401.4, R401.4.1</p> <p><b>ASCE:</b> ASCE 24 Sec. 1.5.3, 1.5.3.1, 1.5.3.2, 1.5.3.3, ASCE 7 Sec. 1.6</p> <p><b>Other:</b> FEMA 550, FEMA TB #1, FEMA TB #5</p>
<p><b>Enclosures Below Buildings—When Enclosure Constitutes a Substantial Improvement</b></p> <p>NFIP 60.3(e)(5) and 60.3(c)(5)</p>	<p><b>Requirement:</b> Both the enclosure and the existing building must meet current NFIP requirements for new construction in V Zones (see Fact Sheets Nos. 1.4, 1.5, 2.2, 3.1, 8.1, 8.3).</p>	<p><b>Recommendation:</b> Follow the V Zone requirement for building elevation and open foundations.</p> <p><b>Requirement:</b> Both the enclosure and the existing building must meet current NFIP requirements for new construction in A Zones (see Fact Sheets Nos. 1.4, 1.5, 2.2, 3.1, 8.1, 8.3).</p>	<p><b>Recommendation:</b> Elevated bottom of lowest horizontal structural member at, or above, BFE (see Fact Sheet No. 1.4).</p> <p><b>Requirement:</b> Both the enclosure and the existing building must meet current NFIP requirements for new construction in A Zones (see Fact Sheets Nos. 1.4, 1.5, 2.2, 3.1, 8.1, 8.3).</p>	<p><b>IBC:</b> 1612.1, 3404.2</p> <p><b>IRC:</b> R322.1, R322.1.8, R322.3.5</p> <p><b>ASCE:</b> ASCE 24 Sec. 4.6, ASCE 7 Sec. 1.6</p> <p><b>Other:</b> FEMA TB #5, FEMA TB #9</p>
<p><b>Enclosures Below Buildings—When Enclosure Does Not Constitute a Substantial Improvement</b></p> <p>NFIP 60.3(e)(5) and 60.3(c)(5)</p>	<p><b>Recommendation:</b> Make the enclosure compliant with current NFIP requirements for new V Zone construction.</p> <p><b>Requirement:</b> Post-FIRM existing building – the enclosure must meet NFIP requirements in effect at the time the building was originally constructed. Pre-FIRM existing building -- NFIP requirements concerning new construction are not triggered (see Fact Sheet No. 8.1).</p>	<p><b>Recommendation:</b> Construct only breakaway enclosures; install flood openings in the enclosure; do not convert the enclosed space to habitable use.</p> <p><b>Requirement:</b> Post-FIRM existing building -- the enclosure must meet NFIP requirements in effect at the time the building was originally constructed. Pre-FIRM existing building -- NFIP requirements concerning new construction are not triggered (see Fact Sheet Nos. 3.5, 8.1).</p>	<p><b>Recommendation:</b> Install flood openings in the enclosure; do not convert the enclosed space to habitable use.</p> <p><b>Requirement:</b> Post-FIRM existing building – the enclosure must meet NFIP requirements in effect at the time the building was originally constructed. Pre-FIRM existing building -- NFIP requirements concerning new construction are not triggered (see Fact Sheet Nos. 3.5, 8.1).</p>	<p><b>IBC:</b> 1612.1, 3404.2</p> <p><b>IRC:</b> N/A</p> <p><b>ASCE:</b> ASCE 24 Sec. 4.6</p> <p><b>Other:</b> FEMA TB #1, FEMA TB #5, FEMA TB #9</p>

Coastal Construction Requirements and Recommendations				
	V Zone 	Coastal A Zone 	A Zone 	Additional Resources
<b>Repairs, Remodeling, and Additions [See Fact Sheet No. 9.1]</b>				
<b>Reconstruction of Destroyed or Razed Building</b> NFIP 60.3(e)(5) and 60.3(c)(5)	<b>Requirement:</b> Where the entire building is destroyed, damaged, or purposefully demolished or razed, the replacement building must meet current NFIP requirements concerning new construction in V Zones, even if it is built on the foundation from the original building (see Fact Sheet Nos. 1.4, 1.5, 9.1).	<b>Recommendation:</b> Follow the V Zone requirement for building elevation and open foundations. <b>Requirement:</b> Where the entire building is destroyed, damaged, or purposefully demolished or razed, the replacement building must meet current NFIP requirements concerning new construction in A Zones, even if it is built on the foundation from the original building (see Fact Sheet Nos. 1.4, 9.1).	<b>Requirement:</b> Where the entire building is destroyed, damaged, or purposefully demolished or razed, the replacement building must meet current NFIP requirements concerning new construction in A Zones, even if it is built on the foundation from the original building (see Fact Sheet Nos. 1.4, 9.1).	<b>IBC:</b> 1810.1.2, 105.1, K103.1 <b>IRC:</b> R105.1, AJ501.3, AJ501.4, AJ501.5.1, AJ501.5, AJ501.5.1, AJ501.5.2, AJ501.5.3, AJ501.5.3.1, AJ501.5.3.2, AJ501.5.3.3, AJ501.5.3.4 AJ501.5.3.5, AJ501.6, AJ501.7, AJ501.8, AJ501.8.1, AJ501.8.2, AJ501.8.3 <b>ASCE:</b> N/A <b>Other:</b> FEMA 550
<b>Moving Existing Building</b> NFIP 60.3(e)(5) and 60.3(c)(5)	<b>Requirement:</b> Where the existing building is moved to new location or site, the relocated building must meet current NFIP requirements concerning construction in V Zones (see Fact Sheet Nos. 1.4, 1.5, 9.1).	<b>Recommendation:</b> Follow the V Zone requirement for building elevation and open foundations. <b>Requirement:</b> Where the existing building is moved to new location or site, the relocated building must meet current NFIP requirements concerning construction in A Zones (see Fact Sheet Nos. 1.4, 9.1).	<b>Recommendation:</b> Elevate bottom of lowest horizontal structural member at, or above, BFE (see Fact Sheet No. 1.4). <b>Requirement:</b> Where the existing building is moved to new location or site, the relocated building must meet current NFIP requirements concerning construction in A Zones (see Fact Sheet Nos. 1.4, 9.1).	<b>IBC:</b> 3410.1 <b>IRC:</b> AE102.6 <b>ASCE:</b> ASCE 7 Sec. 1.6 <b>Other:</b> FEMA 550
<b>Manufactured Housing</b>				
<b>General</b>				<b>IRC:</b> R322.1.9, App. AE101 <b>ASCE:</b> Not Applicable <b>Other:</b> FEMA 85

Developed in association with the National Association of Home Builders Research Center



# Using a Digital Flood Insurance Rate Map (DFIRM)

**Purpose:** To explain the purpose of Flood Insurance Rate Maps (FIRMs), Digital Flood Insurance Rate Maps (DFIRMs), highlight features that are important to coastal builders, and explain how to obtain FIRMs, DFIRMs, and Flood Insurance Studies (FISs).

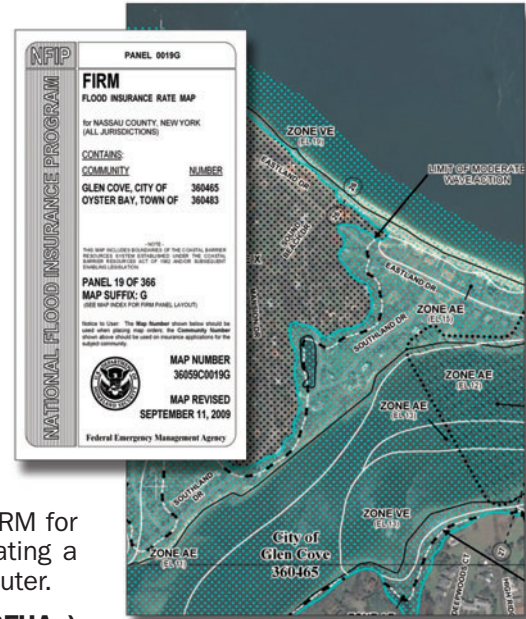
## What Is a FIRM?

Flood-prone areas are studied by engineers and hydrologists that specialize in analysis of streams, rivers, tidal shorelines, and their adjacent floodplain or coastal area. These published studies, known as the community's **FIS**, provide detailed information on the study area that facilitates the creation of flood maps. FISs are usually produced for the highest risk streams, most rivers, and almost all coastal reaches.

FEMA has mapped flood hazards for nearly 20,000 communities in the United States, most commonly on FIRMs. Most of the nation's FIRMs were converted during the past five years through the Map Modernization Program into a digital product that depicts flood-prone areas for a community. These are known as **Digital Flood Insurance Rate Maps**, or **DFIRMs**.

Effective October 1, 2009, FEMA discontinued the distribution of paper maps. Paper FIRMs were replaced with DFIRMs. The FIRM for your specific site can be viewed online and reproduced by creating a printable **FIRMette**<sup>1</sup> that can be downloaded to a personal computer.

DFIRMs show the delineation of the **Special Flood Hazard Areas (SFHAs)** – land areas subject to inundation by a flood that has a 1-percent probability of being equaled or exceeded in any given year (hence, the terms “1-percent-annual-chance flood” and “100-year flood”). SFHAs are shaded on the DFIRM and are divided into different flood zones, depending on the nature and severity of the flood hazard. DFIRM datasets have been provided to your local community and are available for viewing at the local National Flood Insurance Program (NFIP) coordinator's office.



### FIRMs and DFIRMs Are Used By:

- **Communities**, to regulate new construction\* (e.g., foundation type, lowest floor elevation, use of the enclosed areas below the lowest floor).
- **Designers and Builders**, to determine flood hazards and plan new construction per community ordinance and code requirements.
- **Lenders**, to determine whether flood insurance is required for federally backed mortgages.
- **Insurance Agents**, to establish flood insurance premiums.
- **Land surveyors and engineers**, to complete National Flood Insurance Program (NFIP) elevation certificates (see Fact Sheet No. 1.4, *Lowest Floor Elevation*).

\* Note that new construction may include some additions, improvements, repairs, and reconstruction. Consult the community about substantial improvement and substantial damage requirements.

1 FIRMettes are user-selected portions of flood maps available through the FEMA Map Service Center.



## Why Are FIRMs and DFIRMs Important?

- FIRMs and DFIRMs show the boundaries of modeled flood hazard areas in a community.
- SFHAs shown on the maps are used to set flood insurance rates and premiums.
- The 1-percent-annual-chance flood elevations and flood depths shown on FIRMs and DFIRMs are the minimum regulatory elevations on which community floodplain management ordinances and building codes are based.
- The information shown on these maps can affect the design and construction of new buildings and infrastructure, the improvement and repair of existing buildings, and additions to existing buildings (see Fact Sheet Nos. 1.2, *Summary of Coastal Construction Requirements and Recommendations for Flood Effects*, and 8.3, *Protecting Utilities*).

## What Are Flood Zones and Base Flood Elevations, and How Do They Affect Coastal Buildings?

- **BFEs** are typically shown on DFIRMs for riverine flood zones (Zone A, AE, AO, and AH) and coastal flood zones (Zone V and VE). **The BFE is the predicted elevation of flood waters and wave effects during the 1-percent-annual-chance flood (also known as the base flood).** The BFE is referenced to the vertical datum shown on the DFIRM. Most have been updated to the 1988 North American Vertical Datum.
- The minimum **lowest floor elevation and the foundation type and design** for new construction\* are determined by the BFE and flood zone, as required in the community's floodplain management ordinance and building code (see Fact Sheet Nos. 1.4, *Lowest Floor Elevation*, and 3.1, *Foundations in Coastal Areas*). This ordinance, along with the most current DFIRM and FIS, are adopted by resolution to meet NFIP participation requirements. Use of these tools supports community planning, zoning, and building inspection programs that require specific structure design and new construction\* in high-hazard coastal floodplains.

Some communities have adopted higher standards for coastal construction (e.g., lowest floor elevations above the BFE [freeboard], restrictions on foundation types, and enclosures in Zone A). *Builders should consult their local jurisdiction for details.*

\* Note that new construction may include some additions, improvements, repairs, and reconstruction. Consult the community about substantial improvement and substantial damage requirements.

## Flood Hazard Zones in Coastal Areas

(See the sample DFIRM that follows)

**Zone V:** Areas closest to the shoreline including the Primary Frontal Dune (PFD), subject to storm wave action, high-velocity flow, and erosion during 100-year storm events. Elevations are not provided.

**Zone VE:** Base Flood Elevations (BFEs) are provided on the DFIRM and an additional hazard can be present associated with storm waves greater than 3 feet and including the PFD. BFEs are derived from detailed analyses shown in the FIS.

**Zone A:** Areas subject to flooding during the 1-percent-annual-chance flood. Flood conditions are less severe than in Zone V and MOWAs due to lower wave forces. Because detailed analysis has not been performed, BFEs and flood depths are not provided.

**Zone AE:** Depicts BFEs on the DFIRM. Further details are provided in the FIS on areas where hydrology and hydraulic modeling was performed to determine flood hazard risk.

**Area of Moderate Wave Action (MOWA):** Area landward of Zone V, or landward of an open coast without a mapped Zone V. During base flood conditions, the potential wave height in this area is between 1.5 and 3 feet above the 1-percent-annual-chance stillwater flood depth. While this area is not specifically labeled on the DFIRM panel, this is the area between the LiMWA and the VE/AE zone boundary. In many codes and standards it is referred to as the "Coastal A Zone."

**Zone AO:** Areas subject to shallow flooding or sheet flow during the 1-percent-annual-chance flood. If they appear on a coastal DFIRM they will most likely be found on the landward slopes of shoreline dunes and overtopped structures. Flood depths, rather than BFEs, are shown for Zone AO.

**Zone AH:** Areas subject to inundation by 1-percent-annual-chance shallow flooding (usually areas of ponding) where average depths are between 1 foot and 3 feet.

**Zone X:** Areas with a lower probability of flooding (<1%); these areas are generally not regulated through community floodplain management ordinances and building codes due to their lower predicted risk of flooding.



## Sample DFIRM

This map is a portion of the DFIRM for the Town of Oyster Bay and the City of Glen Cove in Nassau County, New York. Several important things to note are highlighted:

The community identification number is 360465 for Glen Cove and 360483 for Oyster Bay.

The panel number is 19. Note that an Index Map is available showing all DFIRM panels for all communities within Nassau County.

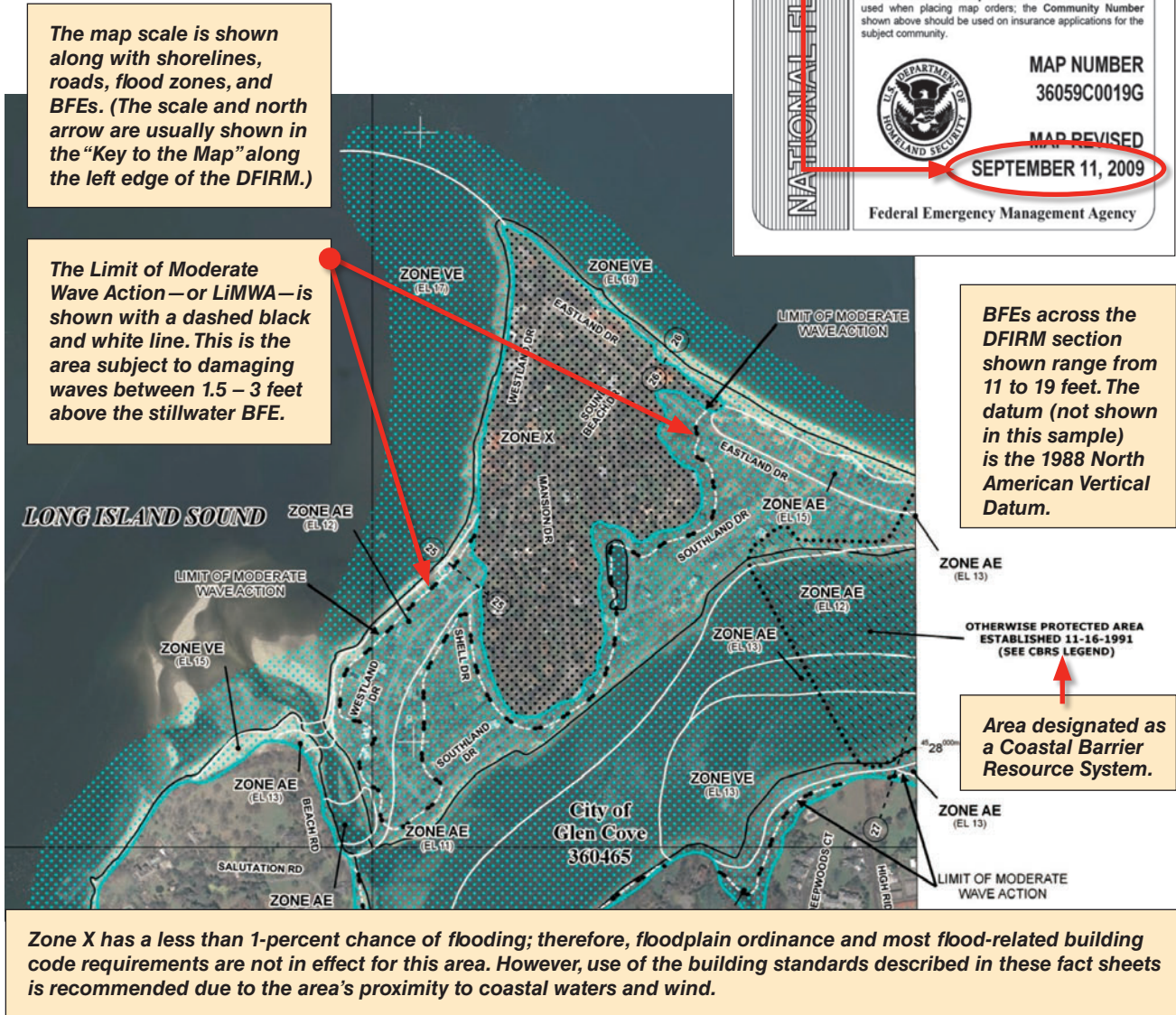
The effective date of the DFIRM is September 11, 2009.

The map scale is shown along with shorelines, roads, flood zones, and BFEs. (The scale and north arrow are usually shown in the "Key to the Map" along the left edge of the DFIRM.)

The Limit of Moderate Wave Action—or LiMWA—is shown with a dashed black and white line. This is the area subject to damaging waves between 1.5 – 3 feet above the stillwater BFE.

BFEs across the DFIRM section shown range from 11 to 19 feet. The datum (not shown in this sample) is the 1988 North American Vertical Datum.

Area designated as a Coastal Barrier Resource System.



Zone X has a less than 1-percent chance of flooding; therefore, floodplain ordinance and most flood-related building code requirements are not in effect for this area. However, use of the building standards described in these fact sheets is recommended due to the area's proximity to coastal waters and wind.

## Is There Anything Else I Should Know About Coastal Flood Hazard Areas and Flood Elevations?

- Many DFIRMs are digital conversions of FIRMs produced during the past few years without improved analysis of flood hazards. While some corrections were made, the maps may not accurately represent coastal flood hazards. Sections 7.8 and 7.9 of FEMA's *Coastal Construction Manual* (FEMA-55, 2005) describe how coastal flood hazards are mapped and how to determine whether coastal FIRMs reflect present-day flood hazards.
- DFIRMs do not incorporate the effects of long-term shoreline erosion. This information should be obtained from other sources.
- Recent post-storm investigations and studies have shown flood forces and damage in Areas of Moderate Water Action (MOWAs) or Coastal A Zones can be very similar to those in Zone V. Some communities have adopted DFIRMs that show MOWAs as a white line on the DFIRM that depicts the LiMWA. Although DFIRMs (and minimum NFIP building standards) do not differentiate between Zone A in coastal areas and Zone A in riverine areas, *builders should consider using Zone V foundation and elevation standards for new construction in the MOWA. These flood zones are depicted as white boundaries on DFIRMs where communities are encouraging use of Zone V standards in MOWAs.*
- Many communities and states require that the lowest floor elevations are above the BFE, offering an additional level of protection known as **Freeboard**. The term used to describe the higher elevation level is **Design Flood Elevation (DFE)**.
- Many property owners have voluntarily constructed their buildings with the lowest floor several feet above the BFE because of the potential for flood waters to exceed the BFE and enter the building. Flood insurance is not available in areas designated as being in the Coastal Barrier Resource System (CBRS). Only structures constructed prior to the designation of the area as being in the CBRS are allowed to purchase federal flood insurance.

## Where Can I Get FIRMs, DFIRMs, Flood Studies, and Other Information?

**Community floodplain administrator.** The community's DFIRMs and its local floodplain management regulations, should be on file and available for viewing at the office of the community floodplain administrator.

**FEMA's Map Information eXchange, or FMIX.** This service center serves as a one-stop shop for a variety of information, products, services, and tools that support the National Flood Insurance Program. To contact a FEMA Map Specialist, please call 1-877-FEMAMAP (1-877-336-2627) or email [FEMAMapSpecialist@riskmapcde.com](mailto:FEMAMapSpecialist@riskmapcde.com). DFIRMs and FISs can be accessed at [www.msc.fema.gov](http://www.msc.fema.gov). Index sheets and specific FIRM panels can be viewed online at the FEMA Map Service Center website by entering either a parcel address or the specific DFIRM panel number, if known. A user-selected portion of flood maps (called a FIRMette) such as the previous sample can be created, saved, and printed. An effective tutorial on interpretation and use of the old FIRM product is available at [www.FloodSmart.gov](http://www.FloodSmart.gov). While not specific to the newer DFIRM platform, the tutorial defines basic flood hazard map terminology and will be helpful to those less experienced with using flood hazard maps.

Information regarding FIRMs, DFIRMs, FISs, and related products can also be obtained from FEMA through FMIX at:

1-877-FEMAMAP (1-877-336-2627)

Or

[FEMAMapSpecialist@riskmap.cde.com](mailto:FEMAMapSpecialist@riskmap.cde.com)

Developed in association with the National Association of Home Builders Research Center



# Lowest Floor Elevation

**Purpose:** To describe the benefits of exceeding the National Flood Insurance Program (NFIP) minimum elevation requirements; to identify common construction practices that violate NFIP regulations, which result in significantly higher flood insurance premiums; and to discuss the NFIP Elevation Certificate.

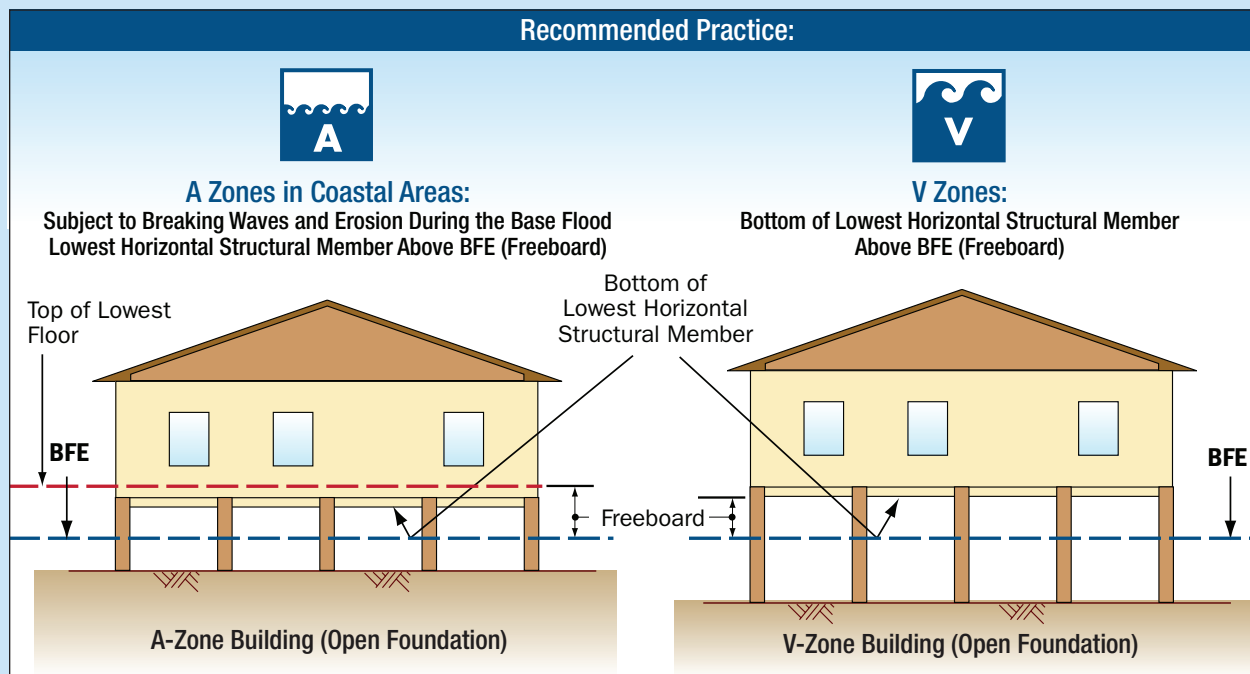
## Why Is the Lowest Floor Elevation Important?

In riverine and other inland areas, experience has shown that if the lowest floors of buildings are not elevated above the flood level, these buildings and their contents will be damaged or destroyed. In coastal areas, wave action causes even more damage, often destroying enclosed building areas below the flood level (and any building areas above the flood level that depend on the lower area for structural support). Once waves rise above the lowest structural member in V Zones or Coastal A Zones, the elevated portion of the building is likely to be severely damaged or destroyed.

### Recommended Lowest Floor Elevations\*

Because of the additional hazard associated with wave action in V Zones and in Coastal A Zones, it is recommended that the elevation requirements of ASCE 24 (that exceed the minimum elevation requirements of the NFIP) be followed:

- The bottom of the lowest horizontal structural member of a building in the V Zone is elevated 1 foot or more above the Base Flood Elevation (BFE) (i.e., add freeboard).
- The lowest horizontal structural member of a building in the A Zone in coastal areas is elevated 1 foot or more above the BFE (i.e., add freeboard).



\* NFIP minimum elevation requirements: A Zones – elevate top of lowest floor to or above BFE; V Zones – elevate bottom of lowest horizontal structural member to or above BFE. In both V Zones and A Zones, many people have decided to elevate a full story to provide below-building parking, far exceeding the elevation requirement. See Fact Sheet No. 1.2 for more information about NFIP minimum requirements in A Zones and V Zones.



## What Does FEMA Consider the Lowest Floor?

- The **lowest floor** means “the lowest floor of the lowest enclosed area, except for unfinished or flood-resistant enclosures used solely for parking of vehicles, building access, or storage.”
- If the lowest enclosed area is used for anything other than **vehicle parking, building access, or storage**, the floor of that area is considered the lowest floor. Such prohibited use will violate NFIP requirements, resulting in drastically increased flood insurance premiums.
- Note that **any below-BFE finished areas**, including foyers, will violate NFIP requirements, may sustain unreimbursable flood damage, and make the building subject to increased flood insurance premiums.
- The floor of a basement (where “basement” means the floor is below grade on all sides) will **always** be the lowest floor, regardless of how the space is used. Basements are prohibited from being constructed in V Zones and A Zones unless the basement is elevated to or above the flood elevation or a basement exception has been granted.
- Walls of enclosed areas below the BFE must meet special requirements in coastal areas (see Fact Sheet No. 8.1, *Enclosures and Breakaway Walls*; TB 5, *Free-of-Obstruction Requirements* (2008); and TB 9, *Design and Construction Guidance for Breakaway Walls Below Elevated Coastal Buildings* (2008)). **However, it should be emphasized that in no instance are basements recommended in Coastal A Zones.**

## Construction Practices and the Lowest Floor

Constructing the lowest floor at the correct elevation is critical. Failure to do so can result in a building being built below the BFE. As a result, construction work can be stopped, certificates of occupancy can be withheld, and correcting the problem can be expensive and time-consuming. Here are some helpful tips to consider when constructing the lowest floor:

- After the piles have been installed and the lowest horizontal structural supporting members have been installed, have a licensed professional engineer, architect, or surveyor validate the intended elevation of the lowest floor before the piles are cut off. This should be noted on the Elevation Certificate.
- Alternatively, after the piers or columns have been constructed, the intended elevation of the lowest floor should be validated during an inspection by the licensed professional and noted on the Elevation Certificate prior to installation of the lowest horizontal structural supporting members.

Do not modify building plans to create habitable space below the intended lowest floor. Doing so will put the building in violation of floodplain management ordinances and building code requirements. Also, this space cannot be converted to living space after the certificate of occupancy is awarded.

## FEMA Elevation Certificate

The NFIP requires participating communities to adopt a floodplain management ordinance that specifies minimum requirements for reducing flood losses. Communities are required to **obtain and maintain a record of the lowest floor elevations for all new and substantially improved buildings**. The Elevation Certificate (see the following pages) allows the community to comply with this requirement and provides insurers the necessary information to determine flood insurance premiums.

A licensed surveyor, engineer, or architect must complete, seal, and submit the Elevation Certificate to the community code official. Not placing the lowest supporting horizontal members and the first floor of a building at the proper elevation in a coastal area can be extremely costly and difficult to correct. Following the carpenter’s adage to measure twice, but cut once, the elevation of the building must be checked at several key stages of construction. Note that **multiple Elevation Certificates may need to be submitted for the same building**: a certificate may be required when the lowest floor level is set (and before additional vertical construction is carried out); a final certificate must be submitted **upon completion of all construction prior to issuance of the certificate of occupancy**.

The Elevation Certificate requires that the following information be certified and signed by the licensed professional (surveyor/engineer/architect) and signed by the building owner:

- Name and address of property owner.
- NFIP flood zone and elevation from a Digital Flood Insurance Rate Map (DFIRM) and/or Flood Insurance Study (FIS).
- GPS coordinates.
- Adjacent grade elevation.
- Lowest horizontal structural supporting member elevation.
- Elevation of certain floors in the building.
- Lowest elevation of utility equipment/machinery.

The Elevation Certificate provided in this fact sheet expires March 31, 2012. Updated versions can be found at <http://www.fema.gov/business/nfip/forms.shtm>. The Elevation Certificate and instructions are available on FEMA’s website: <http://www.fema.gov/pdf/nfip/elvcert.pdf>.

# V Zone Design and Construction Certification

**Purpose:** *To explain the certification requirements for structural design and methods of construction in V Zones.*

## Structural Design and Methods of Construction Certification

As part of the agreement for making flood insurance available in a community, the National Flood Insurance Program (NFIP) requires the community to adopt a floodplain management ordinance that specifies minimum design and construction requirements. Those requirements include a **certification of the structural design and the proposed methods of construction** (a similar documentation requirement appears in the 2009 IRC, Section R322.3.6). It is recommended that the design professional use ASCE 24 and ASCE 7 as appropriate engineering standards.

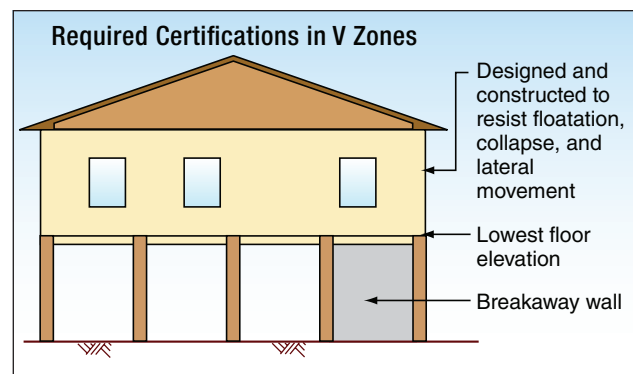
Specifically, NFIP regulations and local floodplain management ordinances require that:

1. A **registered professional engineer or architect shall develop or review the structural design, specifications, and plans** for the construction.
2. A **registered professional engineer or architect shall certify that the design and methods of construction** to be used are in accordance with accepted standards of practice in meeting these criteria:
  - The **bottom of the lowest horizontal structural member of the lowest floor** (excluding the pilings or columns) is elevated to, or above, the Base Flood Elevation (BFE).
  - The pile or column foundation and structure attached thereto is **anchored to resist flotation, collapse, and lateral movement due to the effects of wind and water loads acting simultaneously** on all building components. ASCE 7-10, *Minimum Design Loads for Buildings and Other Structures*, provides guidelines on different load combinations, which include flood and wind loads.

## Completing the V Zone Design Certificate

There is no single V Zone certificate used on a nationwide basis. Instead, local communities and/or states have developed their own certification procedures and documents. Registered engineers and architects involved in V Zone construction projects should **check with the authority having jurisdiction regarding the exact nature and timing of required certifications**.

Page 2 shows a sample certification form. It is intended to show one way that a jurisdiction may require that the certification and supporting information be provided. In this example, the certification statement can address both design and proposed methods of construction and breakaway wall design.



## Other Certifications Required in V Zone

- Breakaway Wall Design, by a registered professional engineer or architect (see Fact Sheet No. 8.1, *Enclosures and Breakaway Walls*)
- “As Built” Lowest Floor Elevation, by a surveyor, engineer, or architect (see Fact Sheet No. 1.4, *Lowest Floor Elevation*)

**The V Zone Design certification should take into consideration the NFIP Free-of-Obstruction requirement for V Zones:** the space below the lowest floor must be free of obstructions (e.g., building element, equipment, or other fixed objects that can transfer flood loads to the foundation, or that can cause floodwaters or waves to be deflected into the building), or must be constructed with non-supporting breakaway walls, open lattice, or insect screening. (See *NFIP Technical Bulletin 5 and Fact Sheet No. 8.1, Enclosures and Breakaway Walls.*)



**Note:** The V Zone design certificate is not a substitute for the NFIP Elevation Certificate (see Fact Sheet No. 1.4, *Lowest Floor Elevation*), which is required to certify as-built elevations needed for flood insurance rating.

## V ZONE DESIGN CERTIFICATE

Name \_\_\_\_\_ Policy Number (*Insurance Co. Use*) \_\_\_\_\_

Building Address or Other Description \_\_\_\_\_

Permit No. \_\_\_\_\_ City \_\_\_\_\_ State \_\_\_\_\_ Zip Code \_\_\_\_\_

### SECTION I: Flood Insurance Rate Map (FIRM) Information

Community No. \_\_\_\_\_ Panel No. \_\_\_\_\_ Suffix \_\_\_\_\_ FIRM Date \_\_\_\_\_ FIRM Zone(s) \_\_\_\_\_

### SECTION II: Elevation Information Used for Design

**[NOTE: This section documents the elevations/depths used or specified in the design – it does not document surveyed elevations and is not equivalent to the as-built elevations required to be submitted during or after construction.]**

1. FIRM Base Flood Elevation (BFE) \_\_\_\_\_ feet\*
2. Community's Design Flood Elevation (DFE) \_\_\_\_\_ feet\*
3. Elevation of the Bottom of Lowest Horizontal Structural Member \_\_\_\_\_ feet\*
4. Elevation of Lowest Adjacent Grade \_\_\_\_\_ feet\*
5. Depth of Anticipated Scour/Erosion used for Foundation Design \_\_\_\_\_ feet
6. Embedment Depth of Pilings or Foundation Below Lowest Adjacent Grade \_\_\_\_\_ feet

\* Indicate elevation datum used in 1-4:  NGVD29  NAVD88  Other \_\_\_\_\_

### SECTION III: V Zone Design Certification Statement

I certify that: (1) I have developed or reviewed the structural design, plans, and specifications for construction of the above-referenced building and (2) that the design and methods of construction specified to be used are in accordance with accepted standards of practice\*\* for meeting the following provisions:

- The bottom of the lowest horizontal structural member of the lowest floor (excluding piles and columns) is elevated to or above the BFE.
- The pile and column foundation and structure attached thereto is anchored to resist flotation, collapse, and lateral movement due to the effects of the wind and water loads acting simultaneously on all building components. Water loading values used are those associated with the base flood\*\*\*. Wind loading values used are those required by the applicable State or local building code. The potential for scour and erosion at the foundation has been anticipated for conditions associated with the base flood, including wave action.

### SECTION IV: Breakaway Wall Design Certification Statement

**NOTE. This section must be certified by a registered engineer or architect when breakaway walls are designed to have a resistance of more than 20 psf (0.96 kN/m<sup>2</sup>) determined using allowable stress design]**

I certify that: (1) I have developed or reviewed the structural design, plans, and specifications for construction of breakaway walls to be constructed under the above-referenced building and (2) that the design and methods of construction specified to be used are in accordance with accepted standards of practice\*\* for meeting the following provisions:

- Breakaway wall collapse shall result from a water load less than that which would occur during the base flood\*\*\*.
- The elevated portion of the building and supporting foundation system shall not be subject to collapse, displacement, or other structural damage due to the effects of wind and water loads acting simultaneously on all building components (see Section III).

### SECTION V: Certification and Seal

This certification is to be signed and sealed by a registered professional engineer or architect authorized by law to certify structural designs. I certify the V Zone Design Certification Statement (Section III) and \_\_\_\_\_ the Breakaway Wall Design Certification Statement (Section IV, check if applicable).

Certifier's Name \_\_\_\_\_ License Number \_\_\_\_\_

Title \_\_\_\_\_ Company Name \_\_\_\_\_

Address \_\_\_\_\_

City \_\_\_\_\_ State \_\_\_\_\_ Zip Code \_\_\_\_\_

Signature \_\_\_\_\_ Date \_\_\_\_\_ Telephone \_\_\_\_\_

Place Seal Here

# Designing for Flood Levels Above the BFE

**Purpose:** *To recommend design and construction practices that reduce the likelihood of flood damage in the event that flood levels exceed the Base Flood Elevation (BFE).*

## Key Issues

- BFEs are established at a flood level, including wave effects, that has a 1-percent chance of being equaled or exceeded in any given year, also known as the 100-year flood or base flood. Floods more severe and less frequent than the 1-percent flood can occur in any year.
- Flood levels during some recent storms have exceeded BFEs depicted on the Flood Insurance Rate Maps (FIRMs), sometimes by several feet. In many communities, flooding extended inland, well beyond the 100-year floodplain (Special Flood Hazard Area [SFHA]) shown on the FIRM (see Figure 1).
- Flood damage increases rapidly once the elevation of the flood extends above the lowest floor of a building, especially in areas subject to coastal waves. In V Zones, a coastal flood with a wave crest 3 to 4 feet above the bottom of the floor beam (approximately 1 to 2 feet above the walking surface of the floor) will be sufficient to substantially damage or destroy most light-frame residential and commercial construction (see Figure 2).
- There are design and construction practices that can eliminate or minimize damage to buildings when flood levels exceed the BFE. **The most common approach is to add freeboard to the design (i.e., to elevate the building higher than required by the FIRM).** This practice is outlined in American Society of Civil Engineers (ASCE) 24-05, *Flood Resistant Design and Construction*.
- There are other benefits of designing for flood levels above the BFE: reduced building damage and maintenance, longer building life, reduced flood insurance premiums, reduced period of time in which the building occupants may need to be displaced in the event of a flood disaster (and need for temporary shelter and assistance), reduced job loss, and increased retention of tax base.
- The cost of adding freeboard at the time of home construction is modest, and reduced flood insurance premiums will usually recover the freeboard cost in a few years' time.



**Figure 1.** Bridge City, Texas, homes were flooded during Hurricane Ike, even though they were constructed outside the SFHA and in Zone B. The flood level was approximately 4' above the closest BFE.



**Figure 2.** Bolivar Peninsula, Texas, V Zone house constructed with the lowest floor (bottom of floor beam) at the BFE (dashed line). The estimated wave crest level during Hurricane Ike (solid line) was 3' to 4' above the BFE at this location.



## How High Above the BFE Should a Building be Elevated?

Ultimately, the building elevation will depend on several factors, all of which must be considered before a final determination is made:

- **The accuracy of the BFE shown on the FIRM:** If the BFE is suspect, it is probably best to elevate 3 or more feet above the BFE; if the BFE is deemed accurate, it may only be necessary to elevate a couple of feet above the BFE.
- **If historical high water levels are above the BFE,** the historical high water levels should be considered in building elevation decisions.
- **Availability of preliminary Digital Flood Insurance Rate Maps (DFIRMs):** As new Flood Insurance Studies (FISs) are completed, preliminary DFIRMs will be produced and available for use, even before they are officially adopted by those communities.
- **Future conditions:** Since the FIRM reflects conditions at the time of the FIS, some owners or jurisdictions may wish to consider future conditions (such as sea level rise, subsidence, wetland loss, shoreline erosion, increased storm frequency/intensity, and levee settlement/failure) when they decide how high to elevate.
- **State or local requirements:** The state or local jurisdiction may require a minimum freeboard through its floodplain management requirements or building code.
- **Building code requirements:** The International Building Code (IBC) requires buildings be designed and constructed in accordance with ASCE 24. ASCE 24 requires between 0 and 2 feet of freeboard, depending on the building importance and the edition of ASCE 24 referenced.<sup>1</sup> The 2009 International Residential Code (IRC) requires 1 foot of freeboard in V Zones and in Coastal A Zones.
- **Building owner tolerance for damage, displacement, and downtime:** Some building owners may wish to avoid building damage and disruption, and may choose to elevate far above the BFE.

In V Zones and A Zones, FEMA 499 recommends considering elevation of residential structures to the 500-year flood elevation, or to the requirements of ASCE 24-05, whichever is higher.

<sup>1</sup> The 1998 edition of ASCE 24 is referenced by the 2003 edition of the IBC, and requires between 0 and 1 foot of freeboard. The 2005 edition of ASCE 24 is referenced by the 2006 and 2009 editions of the IBC, and require between 0 and 2 feet of freeboard.

If the 500-year stillwater elevation (feet North American Vertical Datum of 1988 [NAVD] or feet National Geodetic Vertical Datum of 1929 [NGVD]) is not available, a rule of thumb can be used to approximate it as 1.25 times the 100-year stillwater elevation (feet NAVD or feet NGVD).

The 500-year wave crest elevation **can** be approximated as 1.25 times the BFE.

## Flood Insurance Rate Maps and Flood Risk

Hurricanes Ivan (2004), Katrina (2005), Rita (2005), and Ike (2008) have demonstrated that constructing a building to the minimum National Flood Insurance Program (NFIP) requirements—or constructing a building outside the SFHA shown on the FIRMs—is no guarantee that the building will not be damaged by flooding.

This is due to two factors: 1) flooding more severe than the base flood occurs, and 2) some FIRMs, particularly older FIRMs, may no longer depict the true base flood level and SFHA boundary.

Even if the FIRM predicted flood levels perfectly, buildings constructed to the elevations shown on the FIRM will offer protection only against the 1-percent-annual-chance flood level (BFE). Some coastal storms will result in flood levels that exceed the BFE, and buildings constructed to the minimum elevation could sustain flood damage. The black line in Figure 3 shows the probability that the level of the flood will exceed the 100-year flood level during time periods between 1 year and 100 years; there is an 18 percent chance that the 100-year flood level will be exceeded in 20 years, a 39 percent chance it will be exceeded in 50 years, and a 51 percent chance it will be exceeded in 70 years. As the time period increases, the likelihood that the 100-year flood will be exceeded also increases.

Figure 3 also shows the probabilities that floods of other severities will be exceeded. For example, taking a 30-year time period where there is a 26 percent chance that the 100-year flood level will be exceeded and a 6 percent chance that a flood more severe than the 500-year flood will occur.

### Elevation Recommendation

FEMA 499 recommends new and reconstructed residential buildings be elevated above the effective BFEs with freeboard equal to that specified in ASCE 24-05, plus 3 feet. When new DFIRMs are available and adopted, 499 additionally recommends new and reconstructed residential buildings be elevated to or above the freeboard elevation specified by ASCE 24-05.



FIRMs depict the limits of flooding, flood elevations, and flood zones during the base flood. As seen in Figure 3, buildings elevated only to the BFEs shown on the FIRMs have a significant chance of being flooded over a period of decades. Users should also be aware that the flood limits, flood elevations, and flood zones shown on the FIRM reflect ground elevations, development, and flood conditions at the time of the FIS.<sup>2</sup>

**FIRMs do not account for the following:**

- Shoreline erosion, wetland loss, subsidence, and relative sea level rise
- Upland development or topographic changes
- Degradation or settlement of levees and floodwalls
- Changes in storm climatology (frequency and severity)
- The effects of multiple storm events

Thus, what was once an accurate depiction of the 100-year floodplain and flood elevations may no longer be so.

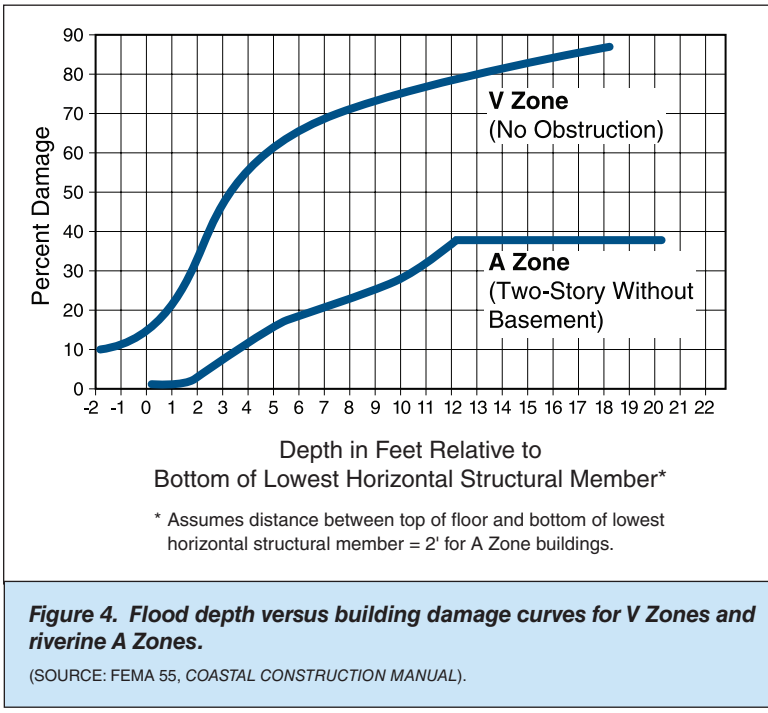
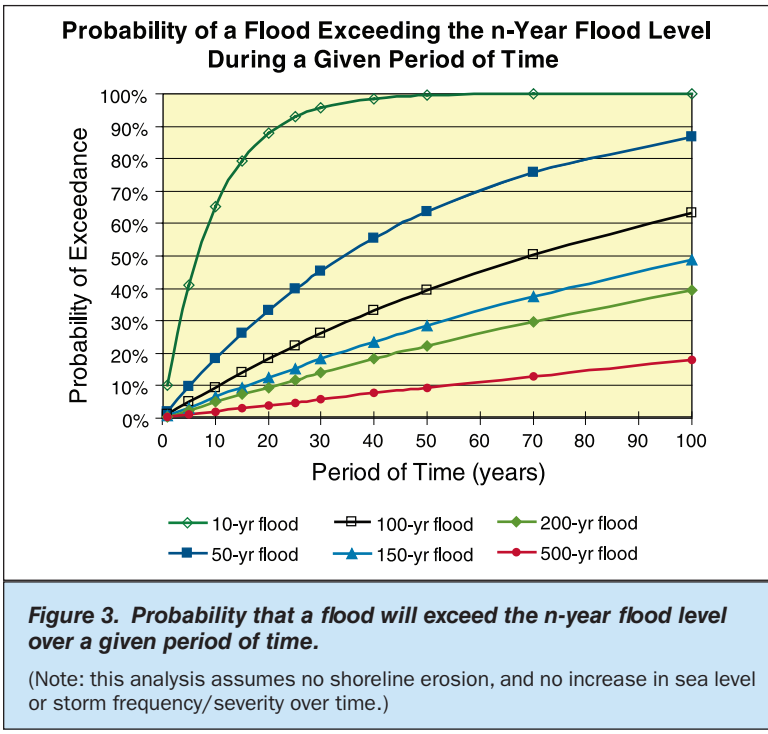
### Consequences of Flood Levels Exceeding the BFE

Buildings are designed to *resist* most environmental hazards (e.g., wind, seismic, snow, etc.), but are generally designed to *avoid* flooding by elevating the building above the anticipated flood elevation. The difference in design approach is a result of the sudden onset of damage when a flood exceeds the lowest floor elevation of a building. Unlike wind—where exposure to a wind speed slightly above the design speed does not generally lead to severe building damage—occurrence of a flood level even a few inches above the lowest floor elevation generally leads to significant flood damage. Therefore, the recommendation is to add freeboard.

This is especially true in cases where waves accompany coastal flooding. Figure 4 illustrates the expected flood damage (expressed as a percent of a building’s pre-damage market value) versus flood depth above the bottom of the lowest horizontal structural member supporting the lowest floor (e.g., bottom of the floor beam), for a building in a V Zone and for a building in a riverine A Zone.<sup>3</sup>

2 Sections 7.8.1.3 and 7.9 of FEMA’s *Coastal Construction Manual* (FEMA 55, 2000 edition) provide guidance on evaluating a FIRM to determine whether it still provides an accurate depiction of base flood conditions, or whether it is obsolete.

3 Since the normal floor reference for A Zone buildings is the top of the lowest floor, the A Zone curve was shifted for comparison with the V Zone curve.



One striking difference between the two curves is that a flood depth in the V Zone (wave crest elevation) 3 to 4 feet above the bottom of the floor beam (or approximately 1 to 2 feet above the top of the floor) is sufficient to cause substantial (>50 percent) damage to a building. In contrast, A Zone riverine flooding (without waves and high velocity) can submerge a structure without causing substantial damage. This difference in building damage is a direct result of the energy contained in coastal waves striking buildings—this type of damage was identified in Texas and Louisiana following Hurricane Ike (see Figure 5).

In cases where buildings are situated behind levees, a levee failure can result in rapid flooding of the area. Buildings near a levee breach may be exposed to high velocity flows, and damages to those buildings will likely be characterized by the V Zone damage curve in Figure 4. Damages to buildings farther away from the breach will be a result of inundation by floodwaters, and will likely resemble the A Zone curve in Figure 4.



**Figure 5. Hurricane Ike damage to buildings. The upper left and upper right photos are of buildings that were close to the Gulf of Mexico shoreline and subjected to storm surge and large waves above the lowest floor. The lower left photo is of a building close to Galveston Bay shoreline and subjected to storm surge and small waves. The lower right photo is of a Cameron Parish, Louisiana, school that was approximately 1.3 miles from the Gulf shoreline, but subjected to storm surge and small waves.**

### General Recommendations

The goal of this fact sheet is to provide methods to minimize damage to buildings in the event that coastal flood levels rise above the BFE. Achieving this goal will require implementation of one or more of the following general recommendations:

- In all areas where flooding is a concern, inside and outside the SFHA, elevate the lowest floor so that the bottom of the lowest horizontal structural member is at or above the Design Flood Elevation (DFE). Do not place the top of the lowest floor at the DFE, since this guarantees flood

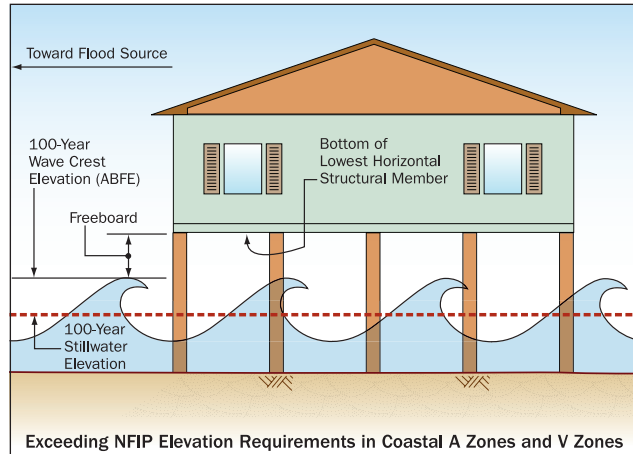
damage to wood floor systems, floor coverings, and lower walls during the design flood, and may lead to mold growth and contamination damage (see Figure 6).

- In V Zones and A Zones, use a DFE that results in freeboard (elevate the lowest floor above the BFE) (see Figure 7).
- In V Zones and A Zones, calculate design loads and conditions (hydrostatic loads, hydrodynamic loads, wave loads, floating debris loads, and erosion and scour) under the assumption that the flood level will exceed the BFE.

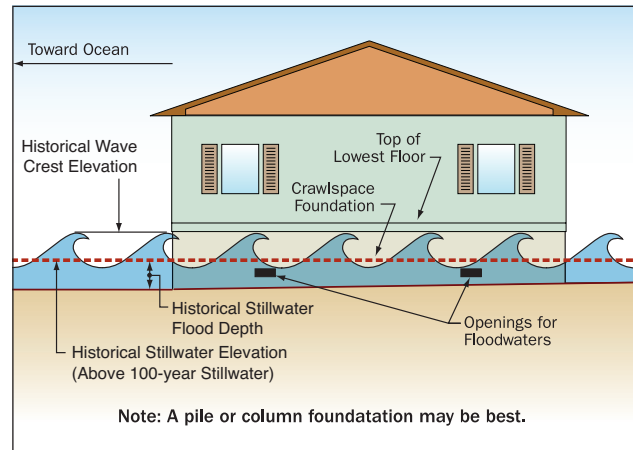


**Figure 6. Mold and biological/chemical contamination are also concerns when flood levels rise above the lowest floor. Contamination may result in the building being irreparable or, at least, make the cleanup, restoration, and repairs more expensive and time-consuming.**

- In an A Zone subject to moderate waves (1.5 to 3.0 feet high) and/or erosion (i.e., Coastal A Zone), use a pile or column foundation (see Figure 7).
- Outside the SFHA (in Zone B, Zone C, and Zone X), adopt flood-resistant design and construction practices if historical evidence or a review of the available flood data shows the building could be damaged by a flood more severe than the base flood (see Figure 8).
- Design and construct buildings in accordance with the latest model building code (e.g., IRC or IBC), ASCE 7-10, *Minimum Design Loads for Buildings and Other Structures* and ASCE 24-05, *Standard for Flood Resistant Design and Construction* as applicable.
- Use the pre-engineered foundations, as applicable, which are shown in FEMA 550, *Recommended Residential Construction for the Gulf Coast: Building on Strong and Safe Foundations*.
- Use strong connections between the foundation and the elevated building to prevent the building from floating or washing off the foundation, in the event that flood levels do rise above the lowest floor.
- Where additional freeboard is prohibited or not provided use flood damage-resistant building materials and methods above the lowest floor. For example, consider using drainable, dryable interior wall assemblies (see Figure 9). This allows interior walls to be opened up and dried after a flood above the lowest floor, minimizing damage to the structure.



**Figure 7. Recommended construction in Coastal A Zone and V Zone.**



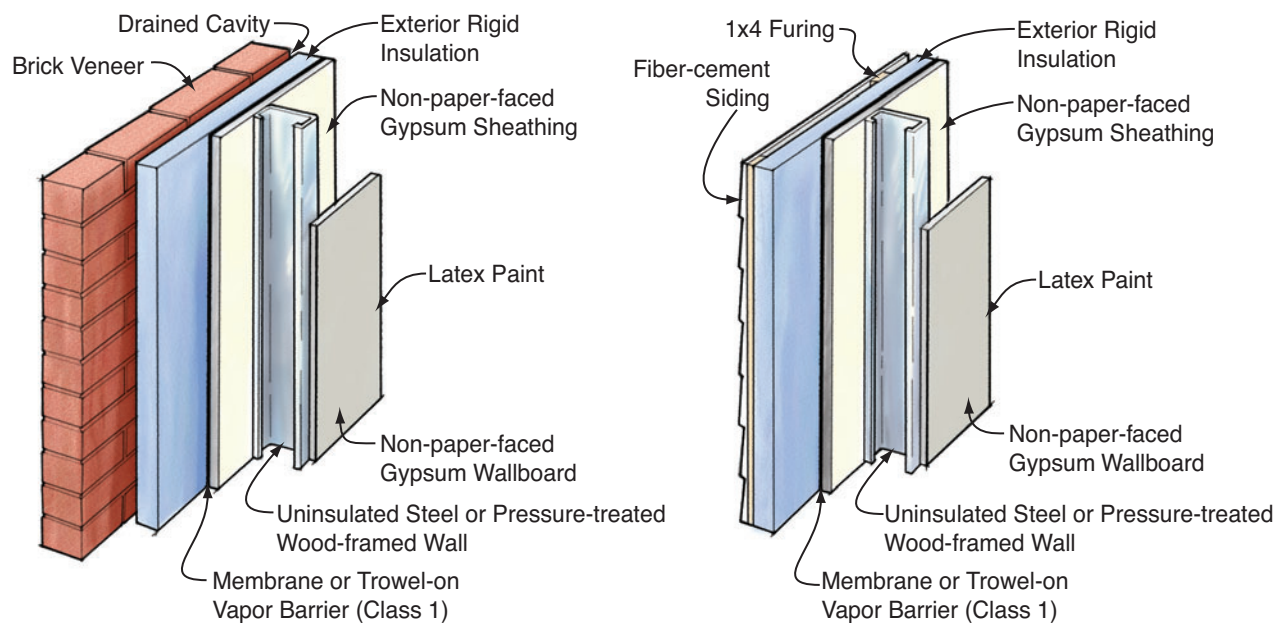
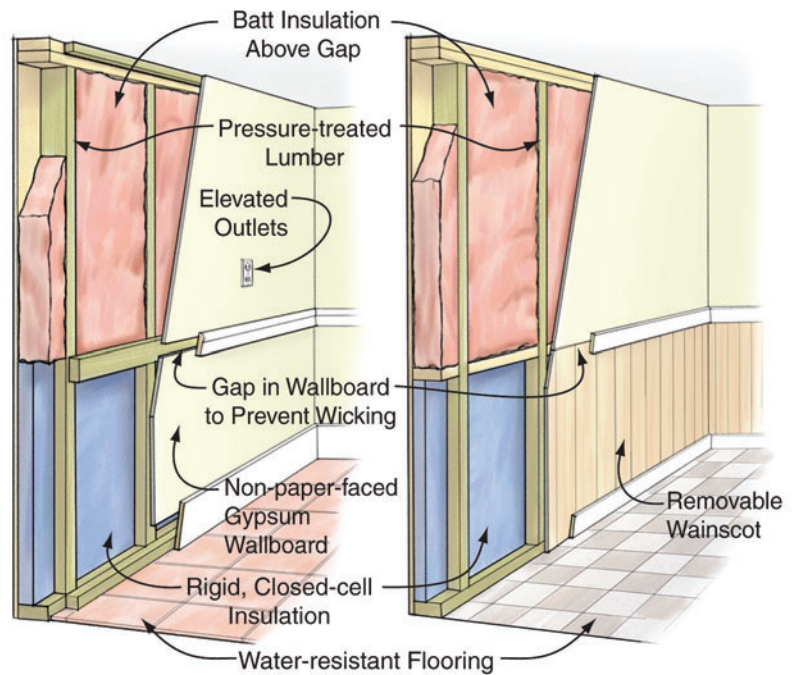
**Figure 8. Recommended construction in Zone B, Zone C, and Zone X.**

- New and replacement manufactured homes should be installed in accordance with the provisions of the 2009 edition of the National Fire Protection Association (NFPA) 225, *Model Manufactured Home Installation Standard*. The standard provides flood, wind, and seismic-resistant installation procedures. It also calls for elevating manufactured homes in A Zones with the bottom of the main chassis frame beam at or above the BFE, not with the top of the floor at the BFE. FEMA P-85, *Protecting Manufactured Homes from Floods and Other Hazards* provides additional guidance on proper manufactured home siting and installation.

**Figure 9. Recommended wet floodproofing techniques for interior wall construction. The following flood damage-resistant materials and methods will prevent wicking and limit flood damage:**

- 1) construct walls with horizontal gaps in wallboard;
- 2) use non-paper-faced gypsum wallboard below gap, painted with latex paint;
- 3) use rigid, closed-cell insulation in lower portion of walls;
- 4) use water-resistant flooring with waterproof adhesive; and
- 5) use pressure treated wood framing

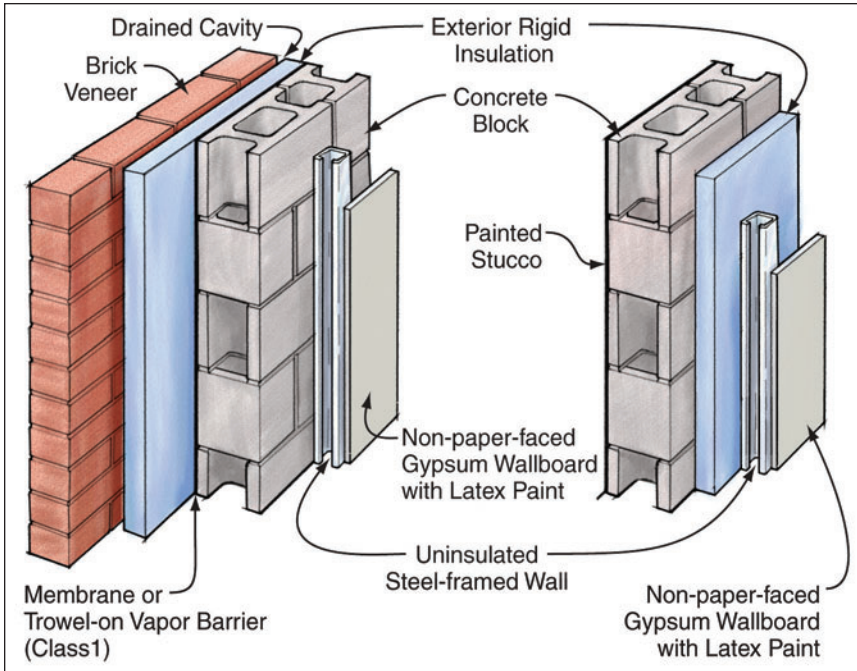
(SOURCE: LSU AGCENTER AND COASTAL CONTRACTOR MAGAZINE).



**Figure 10. Recommended flood-resistant exterior cavity wall construction. The following materials and methods will limit flood damage to exterior cavity walls:**

- 1) use brick veneer or fiber-cement siding, with non-paper-faced gypsum sheathing (vinyl siding is also flood-resistant but is less resistant to wind damage);
- 2) provide cavity for drainage;
- 3) use rigid, closed-cell insulation;
- 4) use steel or pressure-treated wood studs and framing; and
- 5) use non-paper-faced gypsum wallboard painted with latex paint

(SOURCE: COASTAL CONTRACTOR MAGAZINE AND BUILDING SCIENCE CORPORATION).



**Figure 11. Recommended flood-resistant exterior mass wall construction. The following materials and methods will limit flood damage to exterior mass walls:**

- 1) use concrete masonry with stucco or brick veneer (provide drainage cavity if brick veneer is used);**
- 2) use rigid, closed-cell insulation;**
- 3) use steel framing; and 4) use non-paper-faced gypsum wallboard painted with latex paint**

(Source: Coastal Contractor Magazine and Building Science Corporation).

### Other Considerations

As previously stated, in addition to reduced building damage, there are other reasons to design for flood levels above the BFE:

- Reduced building maintenance and longer building life.
- Reduced flood insurance premiums.
- Reduced displacement and dislocation of building occupants after floods (and need for temporary shelter and assistance).

Until flooded, many homeowners and communities do not think about these benefits. However, one of the most persuasive (to homeowners) arguments for elevating homes above the BFE is the reduction in annual flood insurance premiums. In most cases, flood

premiums can be cut in half by elevating a home 2 feet above the BFE, saving several hundred dollars per year in A Zones, and \$2,000 or more per year in V Zones. In V Zones, savings increase with added freeboard.

A comprehensive study of freeboard (American Institutes for Research, 2006) demonstrated that adding freeboard at the time of house construction is cost-effective. Reduced flood damage yields a benefit-cost ratio greater than 1 over a wide range of scenarios, and flood insurance premium reductions make adding freeboard even more beneficial to the homeowner. Reduced flood insurance premiums will pay for the cost of incorporating freeboard in a house in a V Zone in 1 to 3 years; for a house in an A Zone, the payback period is approximately 6 years.

### Flood Insurance Premium Reductions Can Be Significant

Example 1: V Zone building, supported on piles or piers, no below-BFE enclosure or obstruction. \$250,000 building coverage, \$100,000 contents coverage.		Example 2: A Zone building, slab or crawlspace foundation (no basement). \$200,000 building coverage, \$75,000 contents coverage.	
Floor Elevation Above BFE	Reduction in Annual Flood Premium*	Floor Elevation Above BFE	Reduction in Annual Flood Premium*
1 foot	25%	1 foot	39%
2 feet	50%	2 feet	48%
3 feet	62%	3 feet	48%
4 feet	67%	4 feet	48%

\* Compared to flood premium with lowest floor at BFE

## Additional Resources and References

American Institutes for Research. 2006. *Evaluation of the National Flood Insurance Program's Building Standards*, (<http://www.fema.gov/library/viewRecord.do?id=2592>)

ASCE. 2005. *Minimum Design Loads for Buildings and Other Structures*. ASCE 7-05.

ASCE. 2005. *Standard for Flood Resistant Design and Construction*. ASCE 24-05.

Coastal Contractor Magazine. July 2006. *Low Country Rx: Wet Floodproofing. Drainable, dryable assemblies made with water-tolerant materials help speed recovery from deeper than-expected floods*, by Ted Cushman, (<http://www.coastalcontractor.net/cgi-bin/issue.pl?issue=9>)

FEMA. 2000. *Coastal Construction Manual*. FEMA 55. (ordering information at: [http://www.fema.gov/pdf/plan/prevent/nhp/nhp\\_fema55.pdf](http://www.fema.gov/pdf/plan/prevent/nhp/nhp_fema55.pdf))

FEMA. 2009. *Mitigation Assessment Team Report, Hurricane Ike in Texas and Louisiana: Building Performance Observations, Recommendations, and Technical Guidance*. FEMA P-757. (available at: <http://www.fema.gov/library/viewRecord.do?id=3577>)

FEMA. 2009. *Protecting Manufactured Homes from Floods and Other Hazards*. FEMA P-85, (<http://www.fema.gov/library/viewRecord.do?fromSearch=fromsearch&id=1577>)

FEMA. 2010. *Recommended Residential Construction for the Gulf Coast, Building on Strong and Safe Foundations*. FEMA 550, (<http://www.fema.gov/library/viewRecord.do?id=1853>)

LSU AgCenter. 1999. *Wet Floodproofing. Reducing Damage from Floods*. Publication 2771, (<http://www.lsuagcenter.com/NR/rdonlyres/B2B6CDEC-2B58-472E-BBD9-0BDEB0B29C4A/26120/pub2771Wet6.pdf>)

NFPA. 2009. *Model Manufactured Home Installation Standard*. NFPA 225, ([http://www.nfpa.org/about-the-codes/AboutTheCodes.asp?DocNum=225&cookie\\_test=1](http://www.nfpa.org/about-the-codes/AboutTheCodes.asp?DocNum=225&cookie_test=1))

Developed in association with the National Association of Home Builders Research Center



# Coastal Building Materials

**Purpose:** *To provide guidance and best practices on selecting building materials to use for coastal construction.*

## Key Issues

This fact sheet will cover special considerations that must be made when selecting building materials for a coastal building. The harsh environment requires that more substantial building materials be used and more care taken when using these materials in order to ensure durability, hazard resistance, and reduce maintenance. The materials discussed can be used when dealing with both flood and wind hazards. Other factors such as corrosion and decay resistance will also be covered. Although proper design is a key element it will be for naught if the proper materials are not selected. This fact sheet is also intended to provide the reader an idea of what the best practice should be when selecting a material for a coastal building. The following are some key considerations when screening materials.



Select building materials that can endure periodic flooding.

- Materials and construction methods in a coastal environment should be resistant to **flood and wind damage, wind-driven rain, corrosion, moisture, and decay (due to sunlight, aging, insects, chemicals, temperature, or other factors)**.
- Ease of installation or the ability to properly install the material should be a major consideration for the selection of materials.
- All coastal buildings will require **maintenance and repairs** (more so than inland construction) — use proper materials and methods for repairs, additions, and other work following initial construction (see Fact Sheets Nos. 9.1, *Repairs, Remodeling, Additions and Retrofitting – Flood* and 9.2, *Repairs, Remodeling, Additions and Retrofitting – Wind*).

The durability of a coastal home relies on the types of materials and details used to construct it. For flood-related information, see NFIP Technical Bulletin 2, *Flood Damage-Resistant Material Requirements for Buildings Located in the Special Flood Hazard Areas in accordance with the National Flood Insurance Program 8/08*. For other natural hazards, see the *Institute for Business and Home Safety Fortified...for Safer Living® Builder's Guide*.

## Flood-Resistant Materials

Flooding accounts for a large percentage of the damage caused by a coastal storm, which is why building materials must be flood damage-resistant. The NFIP defines a **flood damage-resistant material** as “any building material capable of withstanding direct and prolonged contact (i.e., at least 72 hours) with floodwaters without sustaining significant damage (i.e., requires more than cosmetic repair).” The cost of cosmetic repair should be less than the cost of replacing building materials. Although flood-resistant materials typically refer to areas below the BFE, they may be appropriate in areas above the BFE in order to limit the amount of damage caused by wind-driven rain. **All building materials below the BFE must be flood damage-resistant**, regardless of expected or historic flood duration.

Section 60.3(a)(ii) of the National Flood Insurance Program (NFIP) regulations requires that all new construction and substantial improvements in flood-prone areas be constructed with materials below the Base Flood Elevation (BFE) that are resistant to flood damage. (See Fact Sheet No. 9a for a definition of “substantial improvement.”)



**The following are examples of flood-resistant materials:**

- **Lumber:** Preservative-treated or naturally durable wood as defined in the International Building Code. Naturally durable wood includes the heartwood of redwood, cedar, black locust, and black walnut.
- **Concrete:** A sound, durable mix, and when exposed to saltwater or salt spray, made with a sulfate-resisting cement, with a 28-day compressive strength of 5,000 psi minimum and a water-cement ratio not higher than 0.40—such mixes are usually nominally more expensive and rarely add significant cost to the project (consult ACI 318-02, Building Code Requirements for *Structural Concrete and Commentary* by the American Concrete Institute). Reinforcing steel used in concrete or masonry construction in coastal areas should not be left exposed to moisture and should not be stored on bare ground. The reinforcing steel should be free from rust and clearances should be maintained as shown on the design drawings.
- **Masonry:** Reinforced and fully grouted. If left unfilled, then masonry block cells can create a reservoir that can hold water and can make the masonry difficult to clean following a flood.
- **Structural Steel:** Coated to resist corrosion.
- **Insulation:** Plastics, synthetics, and closed-cell foam, or other types approved by the local building official.

**The following are examples of materials that are unacceptable below the BFE:**

- Normal, water-soluble adhesives specified for above-grade use or adhesives that are not resistant to alkali or acid in water, including groundwater seepage and vapor.
- Materials that contain paper-based materials, wood-based materials, or other organic materials that dissolve or deteriorate, lose structural integrity, or are adversely affected by water.
- Sheet-type floor coverings (e.g., linoleum, vinyl) or wall coverings (e.g., wallpaper) that restrict drying of the materials they cover.
- Materials that become dimensionally unstable when subject to wetting and drying.
- Materials that absorb water excessively or maintain a high moisture content after submergence.
- Wiring, outlets, and electrical components not designed to be flood resistant. It is important to locate any materials like these above the expected floodwater elevation. When this is not possible, it is important to allow for the isolation of these components.

Flood insurance will not pay a claim for damages to finish materials located in basements or in enclosed areas below the lowest floor of elevated buildings, even if such materials are considered to be flood damage-resistant. NFIP claims for damages below the BFE are limited to utilities and equipment, such as furnaces and water heaters.

This table lists examples of flood-resistant materials used in coastal homes.

Location of Material Use	Name of Material
Piles and Posts	Preservative-treated round, tapered wood piles; square-cross section piles; or wood posts.
Piers	Reinforced concrete or concrete masonry units (CMU) (see the section “Flood-Resistant Materials” and Fact Sheet No. 3.4, <i>Reinforced Masonry Pier Construction</i> ).
Foundation Walls	Reinforced concrete or CMU, or wood that is preservative-treated for foundation or marine use (see Fact Sheet No. 3.5, <i>Foundation Walls</i> ).
Beams	Solid sawn timbers and glue-laminated timber products, either naturally durable wood or preservative-treated for above ground exposure; built-up members preservative-treated for ground contact.
Decking	Preservative-treated or naturally durable wood
Framing	Sawn lumber or manufactured lumber that is preservative-treated or naturally durable wood if in close proximity to the ground.
Exterior Sheathing	Plywood that is marine grade or preservative-treated, alkaline copper quaternary (ACQ) or copper azole (C-A)
Subflooring	Plywood that is marine grade or preservative treated, alkaline copper quaternary (ACQ) or copper azole (C-A). (Although providing additional freeboard is recommended, as a redundant hazard mitigation measure, a flood-resistant material can also be considered for the subflooring).



Location of Material Use	Name of Material
Siding	Vinyl siding, fiber cement siding, or heartwood of naturally durable species (see Fact Sheet No. 5.3, <i>Siding Installation in High-Wind Regions</i> ).
Flooring	Latex or bituminous cement formed-in-place, clay, concrete tile, pre-cast concrete, epoxy formed-in-place, mastic flooring, polyurethane formed-in-place, rubber sheets, rubber tiles with chemical-set adhesives, silicone floor formed-in-place, terrazzo, vinyl sheet-goods, vinyl tile with chemical-set adhesives, preservative-treated lumber or lumber from naturally durable wood. (Some tile types attached with ordinary mastic or thin set mortar may not be flood resistant and should be avoided. Verify with a manufacturer that a flooring material is flood-resistant.)
Walls and Ceilings	Cement board, brick, metal, cast stone in waterproof mortar, slate, porcelain, glass, glass block, clay tile, concrete, CMU, preservative-treated wood, naturally durable wood, marine grade plywood, or preservative-treated plywood.
Doors	Metal doors, either hollow, wood core, and foam-filled core should be evaluated after exposure to salt water flooding. Fiberglass, wood core doors may be another alternative to consider.
Insulation	Sprayed polyurethane foam (SPUF) or closed-cell plastic foams
Trim	Preservative-treated or naturally durable wood or artificial stone, steel, or rubber

Although the materials listed are considered flood-resistant materials, some sidings and wall coverings may need to be removed from framing members following a flooding event in order to allow the system to properly dry. For more information on repair techniques after a flood, see FEMA 234, *Repairing Your Flooded Home* (08/92).

Many jurisdictions will provide a list of approved flood-resistant materials that can be used in their local coastal environments. Check these lists and include all proposed construction and materials in approved plans.

## Wind-Resistant Materials

Homes in many coastal areas are often exposed to winds in excess of 90 mph (3-second peak gust). Choose building materials (e.g., roof shingles, siding, windows, doors, fasteners, and framing members) that are designed for use in high-wind areas.

### Examples:

- Roof coverings rated for high winds (see Roofing Category, Fact Sheet Nos. 7.1–7.6)
- Double-hemmed vinyl siding (see Fact Sheet No. 5.3, *Siding Installation in High-Wind Regions*)
- Deformed-shank nails for sheathing attachments (see Fact Sheet No. 7.1, *Roof Sheathing Installation*)
- Wind-borne debris resistant glazing (see Fact Sheet No. 6.2, *Protection of Openings – Shutters and Glazing*)
- Reinforced garage doors

- Tie-down connectors used throughout structure (from roof framing to foundation — see Fact Sheet Nos. 4.1, *Load Paths* and 4.3, *Use of Connectors and Brackets*)
- Wider framing members (2x6 instead of 2x4)

As hurricanes in recent years have proven, even well-selected materials can fail if not installed properly. Proper installation requires attention to detail, following the manufacturer's recommended installation procedures, and proper maintenance. When selecting a material or building component it is important to consider the level of difficulty required to properly install the material. Improper installation of materials may expose the building's systems to wind loads that the systems were not designed to resist. Also, it is important to verify that any special requirements were followed and that specialized tools or adhesives were used. Even a building component that exceeds the design requirements can fail if it is installed incorrectly.

## Corrosion and Decay Resistance

Buildings in coastal environments are prone to damage from corrosion, moisture-related decay, and termite damage to building materials. Metal corrosion is most pronounced on coastal homes (within 3,000 feet of the ocean), but moisture-related decay and termite damage are prevalent throughout coastal areas.

## Corrosion-Resistant Metals

Preservative-treated wood used in a coastal environment often contains chemical preservatives such as Alkaline Copper Quat (ACQ), Copper Azole (CA-C), Dispersed or Micronized Copper ( $\mu$ CA-C), or Copper Naphthenate (CuN-W). The connectors and fasteners used in conjunction with these pressure-treated wood products should be properly selected and it should be verified that the connectors are compatible with the wood preservative. According to the 2009 International Residential Code (IRC) R317.3.1 and International Building Code (IBC) 2304.9.5.1 the fasteners should be compatible with the wood preservative per the manufacturer's recommendations. The fasteners shall be hot-dip zinc-coated galvanized steel, stainless steel, silicon bronze, or copper. If the manufacturer's recommendations are not available, then corrosion protection in accordance with ASTM A 653 type G185 for zinc-coated galvanized steel or equivalent is required. Exceptions to this rule may be noted in the building code.



**Metals corrode at a much faster rate near the ocean. Always use well-protected hardware, such as this connector with thick galvanizing. (For information about pile-to-beam connections, see Fact Sheet No. 3.3, Wood Pile-to-Beam Connections.)**

The term **corrosion-resistant** is widely used but, by itself, is of little help to those specifying or evaluating materials for use in a coastal home. Every material resists corrosion to some extent, or conversely, every material corrodes.

The real issue is *how long will a given material serve its intended purpose at a given home?* The answer depends on the following:

- The material.
- Where it is used in the home.
- Whether installation techniques (e.g., drilling, cutting, bending) will compromise its resistance.
- Its degree of exposure to salt air, moisture, and corrosive agents.
- Whether maintenance required of the homeowner is performed.

**The bottom line: Do not blindly specify or accept a product just because it is labeled corrosion-resistant.** Evaluate the nature of the material, its coating type and thickness (if applicable), and its performance in similar environments before determining whether it is suitable for a particular application.

For guidance on the selection of metal hardware for use in coastal environments, consult an engineer with experience in corrosion protection. For more information about corrosion in coastal environments, see FEMA Technical Bulletin 8-96, *Corrosion Protection for Metal Connectors in Coastal Areas* (see the "Additional Resources" section).

## Recommendations

- Use hot-dip galvanized steel or stainless steel hardware. Stainless steel hardware is acceptable in virtually all locations, but hot-dip galvanized hardware may not be appropriate in every location. Reinforcing steel should be protected from corrosion by sound materials (e.g., masonry, mortar, grout, concrete) and good workmanship (see Fact Sheet No. 4.2, *Masonry Details*). Use galvanized or epoxy-coated reinforcing steel in areas where the potential for corrosion is high (see Fact Sheet No. 3.4, *Reinforced Masonry Pier Construction*).
- It is important to verify that the connector plate and the fastener are the same type of metal. Avoid joining dissimilar metals, especially those with high galvanic potential (e.g., copper and steel) because they are more prone to corrosion.

- Metal-plate-connected trusses should not be exposed to the weather. Truss joints near vent openings are more susceptible to corrosion and may require increased corrosion protection. Verify the connectors used near any roof vent openings are stainless steel or a minimum of ASTM A 653 type G185 zinc-coated galvanized steel or equivalent.
- Due to the potential for galvanic corrosion, standard carbon-steel, aluminum, or electroplated fasteners and hardware are not recommended for direct contact with preservative-treated wood.
- The use of aluminum flashing with many types of treated wood should be avoided. Aluminum will corrode quickly when in contact with most wood preservatives. Copper flashing in many instances is the best choice although products such as vinyl flashing are becoming more common.

## Moisture Resistance

Moisture-resistant materials can greatly reduce maintenance and extend the life of a coastal home. However, such materials by themselves cannot prevent all moisture damage. Proper design and installation of moisture barriers (see Fact Sheet No. 1.9, *Moisture Barrier Systems*) are also required.



**Wood decay at the base of a wood post supported by concrete.**

## Recommendations

- Control wood decay by separating wood from moisture, using preservative-treated wood, using naturally durable wood, and applying protective wood finishes.
- Use proper detailing of wood joints and construction to eliminate standing water and reduce moisture absorption by the wood (e.g., avoid exposure of end grain cuts, which absorb moisture up to 30 times faster than the sides of a wood member).
- Do not use untreated wood in ground contact or high-moisture situations. Do not use untreated wood in direct contact with concrete.
- Field-treat any cuts or drill holes that offer paths for moisture to enter wood members. Field treatment shall be done per M4-06 of the American Wood-Preservers' Association.
- For structural uses, employ concrete that is sound, dense, and durable; control cracks with welded wire fabric and/or reinforcing, as appropriate.
- Use masonry, mortar, and grout that conform to the latest building codes.
- Cavity wall systems (two masonry wall systems separated by a continuous air space) should be avoided in flood-prone areas since they can fill with water, retain moisture, and be difficult to repair without a significant level of demolition.
- Consider the interior finishes for first floors where floodwaters exceeding the design event could cause significant damage (See Fact Sheet No. 1.6, *Designing for Flood Levels Above the BFE*). It is also important to consider that wind-driven rain can cause damage to interior finishes around door and window openings.

## Termite Resistance

Termite damage to wood construction occurs in many coastal areas (attack is most frequent and severe along the southeastern Atlantic and Gulf of Mexico shorelines, in California, in Hawaii, and other tropical areas). Termites can be controlled by soil treatment, termite shields, and the use of termite-resistant materials.

## Recommendations

- Incorporate termite control methods into design in conformance with requirements of the authority having jurisdiction.
- Where a masonry foundation is used and anchorage to the foundation is required for uplift resistance, the upper block cores must usually be completely filled with grout, which may eliminate the requirement for termite shields (see Fact Sheet No. 3.4, *Reinforced Masonry Pier Construction*).
- Use preservative-treated wood for foundations, sills, above-foundation elements, and floor framing.
- In areas with infestations of Formosan termites, wood products treated with insect-resistant chemicals or cold-formed steel framing are material options for providing protection against termite damage.

## Additional Resources

FEMA. NFIP Technical Bulletin 2-08, *Flood-Resistant Materials Requirements*. (<http://www.fema.gov/plan/prevent/floodplain/techbul.shtm>)

FEMA. NFIP Technical Bulletin 8-96, *Corrosion Protection for Metal Connectors in Coastal Areas*. (<http://www.fema.gov/plan/prevent/floodplain/techbul.shtm>)

American Concrete Institute. (<http://www.aci-int.org/general/home.asp>)

American Wood Protection Association. (<http://www.awpa.com>)

*Developed in association with the National Association of Home Builders Research Center*



# Non-Traditional Building Materials and Systems

**Purpose:** *To provide guidance on non-traditional building materials and techniques and their appropriate application in coastal environments.*

## Key Issues

- Determination of whether a material or system is appropriate for the site-specific hazards.
- Evaluation of whether new materials and construction systems should be resistant to flood and wind damage, wind-driven rain, corrosion, moisture, and decay.
- All coastal buildings will require maintenance and repairs (more so than inland construction). When considering using a non-traditional material or system, it is important to ask, "What are some considerations for various new materials and systems?"

Every year, new construction materials are introduced into the market. These building materials cover every part of the home from the foundation system to the roof system. New materials often offer a variety of benefits — a cost-effective solution, energy efficiency, aesthetics, ease of installation, or eco-friendly solutions.

This fact sheet will focus on providing information on building materials and systems that while not being considered traditional materials are not uncommon to the industry. The sheet is not intended to encourage any one material or system, but will provide information so that the user can make a more informed choice about whether something is an appropriate material or system for a given situation. While the fact sheet does not cover all materials, it provides readers with an idea of what criteria they may need to be mindful of when selecting materials and systems. While many are reasonable alternatives to traditional materials and systems, their uses should be carefully considered. The same factors used to consider the applicability of traditional building materials and systems should be used to determine whether new materials and systems are appropriate for use in a coastal environment. Some



**Figure 1. Construction of a modular home.**

of these factors include overall hazard resistance for flood and wind, durability, maintenance, and repair requirements. Additionally, when considering a particular building component, it is important to consider the installation and constructability of the component. When selecting a material or a system for a coastal environment it is important to consider available information in addition to technical data from the manufacturer or supplier. Some examples of considerations are:

- Contact the local building official about the acceptability of the material or system.
- Review test results on the material or system's use in coastal environments.
- Review product code evaluation reports.
- Review field reports or a history of these materials or systems performing well in similar coastal environments, including experience in high winds and flooding.
- Review the manufacturer's installation and maintenance instructions.



Not all materials and systems will be specifically addressed by local building code requirements. Some products or systems may be absent from the code and may require engineering calculations or studies in order to determine that they are appropriate for use in a particular area.

**NOTE:** When considering using new materials or systems, the application of load path connectors should be carefully evaluated. Connectors should be evaluated by testing to demonstrate adequate performance for their intended application. Installation of the connectors should be considered and the ease of installation should be a primary consideration. An improper installation of a connector can result in significant losses in strength.

## System Options

### Engineered Wood Products

A variety of Engineering Wood Products (EWPs) are recognized in the model building codes. Examples include wood structural panels such as plywood and oriented strand board (OSB) and products commonly used as columns and beams such as structural glued laminated timber (glulam) and structural composite lumber (SCL). Glulam is an engineered, stress-rated product of a timber laminating plant comprised of wood laminations of nominal 2 inches or less in thickness bonded together with adhesive. SCL refers to either laminated veneer lumber (LVL), laminated strand lumber (LSL), or oriented strand lumber (OSL), which are comprised of wood in various forms (e.g., veneer, veneer strands, or flaked strands) and structural adhesive. For floor systems, conventional sawn lumber joists and girders (either solid or built-up) are recognized as flood-resistant. If EWPs are used for floor framing they should be either flood-resistant or elevated to a height where they are not expected to be wetted.

#### Advantages:

- EWPs are available in dimensions (length, width, and thickness) that are economical or, in some instances, not possible with sawn lumber.
- Due to availability of larger sizes, EWPs are able to resist greater loads than sawn lumber.
- EWPs are manufactured in a dry condition and are more dimensionally stable than sawn lumber, which may warp and twist during drying.

Things to consider if building with EWPs:

- **Cost:** While EWPs can be used to offer greater spans and exceed the loading properties of conventional lumber, they cost more.

- **Availability:** Certain sizes of Glulam or SCL may be difficult to obtain. They may require special ordering and fabrication, which may not meet the project schedule for the building.
- **Installation:** Installation issues include conditions for storing materials, dimensional compatibility with other materials, and requirements for use of metal connectors and fasteners to ensure accordance with the manufacturer's installation instructions.

### Structural Insulated Panels (SIPs)

Structural Insulated Panels (SIPs) are manufactured panels made of a foam insulation core bonded between two structural facings. SIPs are commonly manufactured with OSB facings as discussed in the 2009 International Residential Code (IRC) Section R613.3.2, but are also available with steel, aluminum, or concrete facings. SIPs can be used for walls (see Figure 2), floors, and roofs, and are compatible with light-framed construction.



**Figure 2. Construction of a Structural Insulated Panel house.**

#### Advantages:

- SIPs offer an efficient construction method and quick assembly. Insulation is built-in, and wall openings and utility chases are precut by the manufacturer per the building plans, reducing on-site coordination and adjustments.
- They increase thermal resistance, reducing heat gain and loss from the building, which allows smaller HVAC equipment to be used in the building.

Things to consider if building with SIPs:

- Evaluate the design loading values of the SIP and verify that the product is appropriate for the wind loading requirements for the building location.
- SIPs are an engineered assembly. SIPs should not be used where they can be flooded unless the entire assembly has been tested for flood resistance. Many SIPs utilize OSB facings. Generally, SIPs should only be used above the base flood elevation (BFE) so that they maintain their structural integrity. Refer to IRC R322.1.8 for requirements for flood-resistant materials. Otherwise, if the SIP is exposed to water damage during flooding, the panel may need to be opened, allowed to dry out, and repaired or, in some instances, even replaced.



**Figure 3. An example of ICF walls and reinforcing steel prior to placement of the concrete. The forms are left in place following placement of the concrete.**

- As with conventional construction techniques, SIPs may sustain windborne debris damage. This may require cutting out a section of the SIPs and repairing it with either conventional framing techniques or a replacement SIP.
- The foam core of SIPs is inert and provides no food value to termites and other pests. However, pests may still nest within the foam. Always incorporate pest control methods into the design in conformance with local jurisdictional requirements. Some manufacturers sell pre-treated SIPs.
- Always use approved connectors and connection methods for panel-to-panel, panel-to-foundation, and panel-to-roof connections. For guidance on SIPs connections, refer to IRC R613.5. It is important to consider that not all connectors are compatible with SIPs and in some instances specific connectors may be required in order to maintain the load path.
- Follow manufacturer's installation instructions and product use requirements in the manufacturer's code evaluation report.

### Insulating Concrete Forms (ICFs)

ICFs are made of molded expanded polystyrene (MEPS) foam and are used to form cast-in-place concrete walls (see Figure 3). Unlike conventional cast-in-place concrete construction, the ICFs are left in place after the concrete cures to provide insulation, an attachment surface for interior and exterior finishes, and space to run plumbing and electrical lines within the wall.

### Advantages:

- ICF provides improved energy efficiency and allows the use of smaller HVAC equipment than some other construction methods.
- The concrete and insulation walls are durable and require little maintenance.
- The combination of thick concrete walls and continuous insulation provide significant noise reduction over other construction methods.
- ICF provides good wind, windborne debris, and flood resistance.

Things to consider if building with ICFs:

- Special connectors may be required for the connection of the roof system, floor system, doors, and windows.
- For material and construction requirements for concrete walls, refer to IRC R611.
- Exterior foam must be protected from sunlight and physical damage by the application of an approved exterior wall covering. Refer to IRC 611.4 for requirements for stay-in-place concrete forms.
- ICF foam is inert and provides no food value to termites and other pests. However, pests may still nest within the foam. Always incorporate pest control methods into the design in conformance with requirements of the authority having jurisdiction.
- In some seismically active areas, constructing large, heavy structures on pile foundations can present significant design challenges. As with any

construction system, construction in areas subject to high erosion or scour could present design challenges due to the mass of an ICF structure.

- Foundation walls built with ICF (with appropriate openings) can be an appropriate foundation system in an A Zone. In V Zones, open foundation systems are required and in Coastal A Zones recommended. ICF and other solid foundation walls are not appropriate to be used in these areas.
- Follow manufacturer’s installation instructions and product use requirements in the manufacturer’s code evaluation report.

### Prefabricated Shear Walls and Moment Frames

Many companies now offer prefabricated shear wall and moment frames that are pre-designed and available in standard sizes. The wall sections and moment frames (see Figure 4) are connected to the rest of the structural framing with bolted, screwed, or nailed connections. Sections are ordered and brought to the site on trucks as one piece or constructed with either bolted or proprietary connectors.

#### Advantages:

- Prefabricated shear walls are often designed to provide for quick installation and compatibility with other framing methods, where narrow wall solutions may not be practical with other framing options.
- Moment frames take the place of shear walls to allow large continuous spaces for windows and other wall openings. Much like the prefabricated shear walls they can be assembled quickly and incorporated into the house framing.

Things to consider if building with prefabricated shear walls and ordinary moment frames:

- Some systems may be limited in their application due to seismic or wind loading requirements.



**Figure 4. Installation of a prefabricated ordinary moment frame.**

- Verify that the members and connections used in the prefabricated sections are designed for the corrosive, moist coastal environment. Preservative-treated wood and galvanized or stainless steel connectors may be required for a coastal application.
- Not all prefabricated shear wall or moment frame systems will be allowed in all locations. It is important to consider that panel substitutions are subject to requirements of the applicable building code. Refer to IRC R602.10 for more information on wall bracing requirements.
- Maintaining the load path is important with any system. Because these systems provide lateral support for the structure, it is important to make sure that the load path will be transferred through the wall system and transferred down to the lower story of foundation and into the ground. Follow the manufacturer’s installation instruction and product use requirements in the manufacturer’s code evaluation report.

### Sprayed Closed-Cell Foam Insulation

Sprayed closed-cell foam polyurethane insulation is used to fill wall cavities in framed construction (see Figure 5). When sprayed, it expands and hardens forming a rigid air barrier and acting as a moisture retardant.

#### Advantages:

- Sprayed closed-cell foam insulation expands to fill wall cavities, small holes, and gaps as it expands, producing a rigid barrier that results in reduced energy costs.
- It is quick to apply and may require less time to install than conventional batt insulation.
- It offers acceptable flood resistance, which is shown in NFIP Technical Bulletin 2-08, *Flood-Resistant Material Requirements for Buildings Located in Special Flood Hazard Areas* in accordance with the National Flood Insurance Program, Table 2.

Things to consider if building with sprayed closed-cell foam insulation:

- Tests have shown that sprayed foam insulation can improve the strength of structural framing systems and connections. However, structural framing systems and connections must be designed and constructed in accordance with all applicable building codes.
- While closed-cell foam is a flood-resistant material, it should be used in conjunction with preservative-treated, or naturally durable, wood or corrosion-resistant metal framing.





**Figure 5. An example of a wall cavity filled with sprayed closed-cell foam insulation.**

- Closed-cell foam should not be confused with other types of insulation. Some varieties of insulation on the market may be more cost-effective and more environmentally friendly; however, many of these products are not considered flood-resistant materials. Testing reports and provisions of the building code should be consulted for applicability in a coastal environment.
- Sprayed foam systems (such as those used in a wall system) create an assembly that when inundated by floodwaters may not be easily dried. For this reason, they are not appropriate to use below the BFE and are not considered flood-resistant material unless the entire assembly has been determined to be flood-resistant.

**NOTE:** Some framing materials such as prefabricated wood I-joists (e.g., a prefabricated I-joist constructed with sawn lumber or composite lumber flanges and plywood or OSB webs) should not be used below the BFE or where subject to flooding (see FEMA Technical Bulletin 2 *Flood-Damage Resistant Materials Requirements*).

## Methods

### Advanced Wall Framing

Advanced wall framing refers to methods designed to reduce the amount of lumber and construction waste generated during home construction. These methods include spacing wall studs up at 24 inches on center rather than 16 inches, and using smaller structural headers and single top plates on interior non-bearing walls.

#### Advantages:

- In most instances, the primary benefit of such techniques is the reduced lumber cost.
- The increased energy efficiency from the reduced number of wall studs and increased wall cavity space for insulation.

#### Things to consider if using advanced wall framing techniques:

- Not all wall framing techniques are applicable for hurricane-prone regions. The designer should carefully consider if this is an appropriate construction method for the area.
- Increasing wall stud spacing, even when using larger lumber sizes, can reduce the ability of a wall to resist transverse loads. For more information on designing framed walls to resist transverse loading, refer to IRC R602.10 or IBC 2305.

Construction crews may be unfamiliar with advanced wall framing techniques, which may increase construction time. Construction plans for advanced framing should be detailed enough for construction crews to recognize differences from conventional techniques, and additional training for construction crews may be required.

### Modular Houses

Modular houses provide an alternative construction method by constructing a traditional wood- or steel-framed house in sections in a manufacturing facility and then delivering the sections to a construction site where they are assembled onto a foundation (see Figure 1). The interior and exterior of the house are finished on site. These houses should not be confused with manufactured homes. Unlike

manufactured homes, modular homes are required to meet the same building code requirements as houses constructed on site.

**Advantages:**

- Sections can be assembled in a controlled environment and construction time is less sensitive to poor weather conditions at the house site.
- Due to the sections being constructed at a manufacturing facility, materials use is often more efficient and fabrication is more efficient than site-built construction, resulting in reduced costs.

Things to consider if using modular houses:

- Proper installation of the house is important. Due to the sections of the house being constructed in another location, tight construction tolerances with the foundation are important in order for the sections to fit together properly.

- Modular homes are to be constructed to the same tolerances and locally enforced building codes as traditional site-built homes. The locally enforced building code where the house will be sited is the standard to which the modular house shall be constructed.
- The manufacturer needs to be aware of the location of the house and the materials that should be used in order to resist the site-specific hazards. Building component choices for flood, wind, and windborne debris-resistant materials should be identified prior to ordering the house and checked before installation begins.
- Extra care should be taken to verify that modular components are properly fastened to building foundations and load path connections are properly completed to transfer building loads from the roof to the foundation.

*Developed in association with the National Association of Home Builders Research Center*



# Moisture Barrier Systems

**Purpose:** To describe the moisture barrier system, explain how typical wall moisture barriers work, and identify common problems associated with moisture barrier systems.

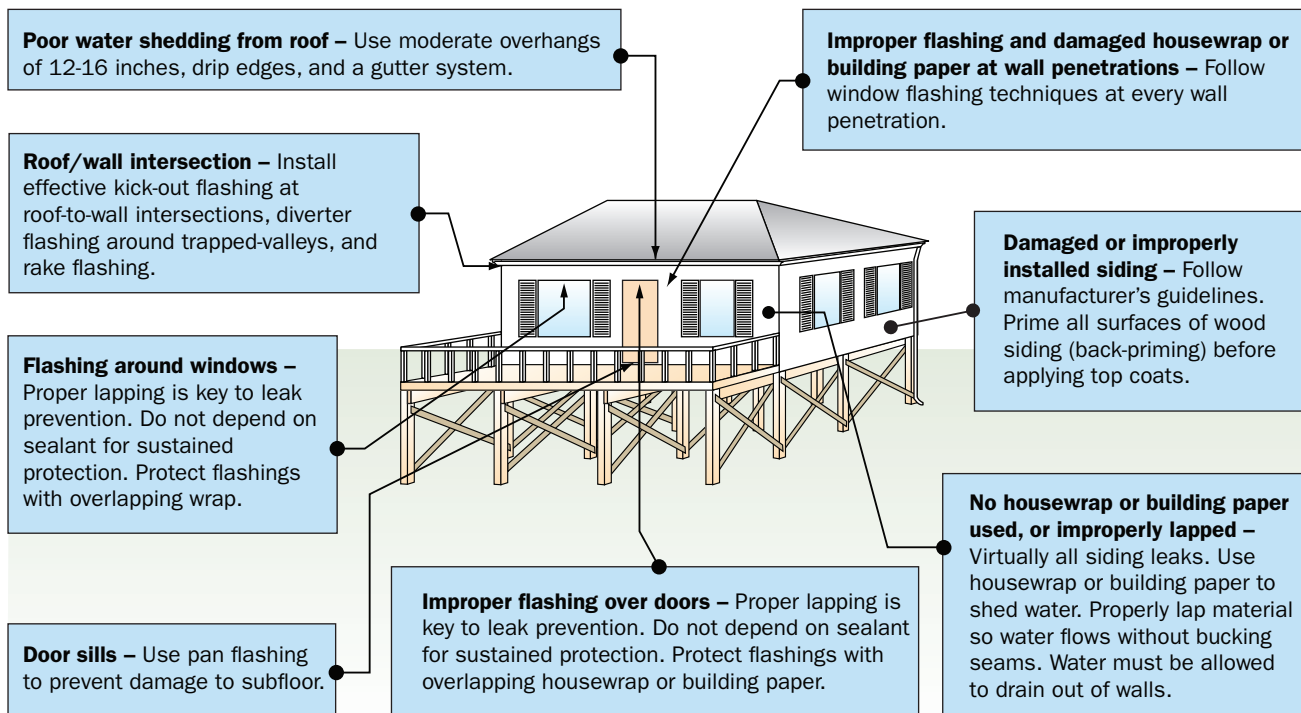
## Key Issues

- A successful moisture barrier system will limit water infiltration into unwanted areas and allow drainage and drying of wetted building materials.
- Most moisture barrier systems for walls (e.g., siding and brick veneer) are “redundant” systems, which require at least two drainage planes (see page 2).
- Housewrap or building paper (asphalt-saturated felt) will provide an adequate secondary drainage plane.
- Proper flashing and lapping of housewrap and building paper are critical to a successful moisture barrier system.
- Sealant should never be substituted for proper layering.



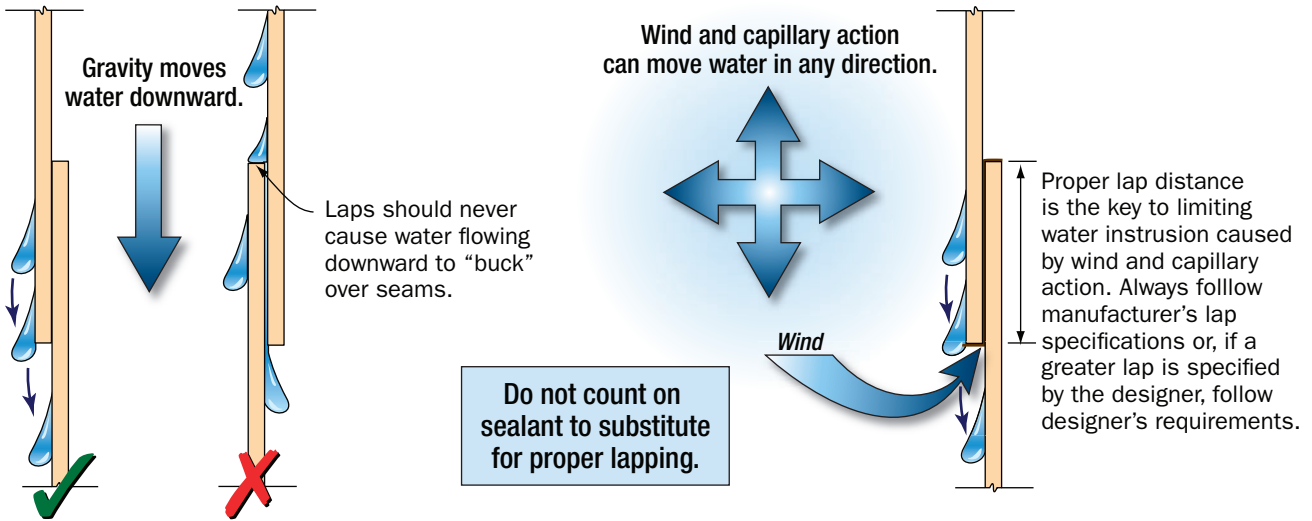
The purpose of the building envelope is to control the movement of water, air, thermal energy, and water vapor. The goal is to prevent water infiltration into the interior, limit long-term wetting of the building components, and control air and vapor movement through the envelope.

## Locations and Causes of Common Water Intrusion Problems



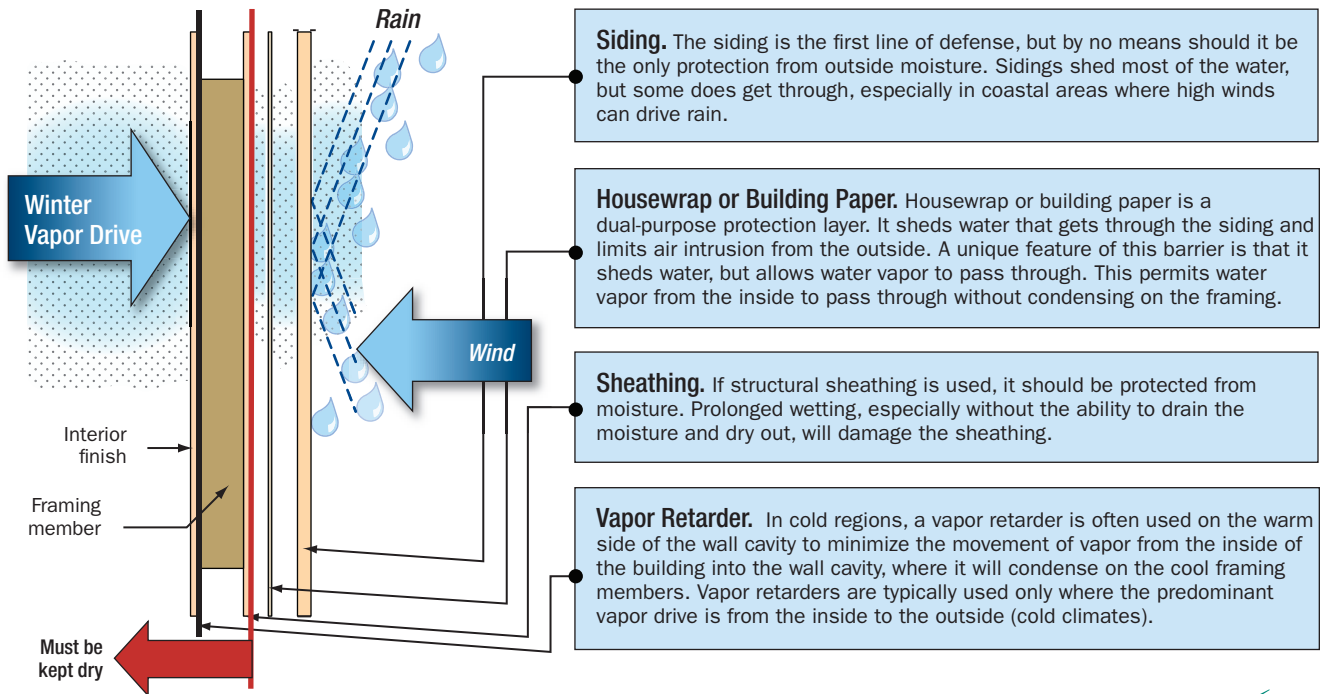
The location of water entry is often difficult to see, and the damage to substrate and structural members behind the exterior wall cladding frequently cannot be detected by visual inspection.

## Proper Lapping Is the Key...



Proper lapping of moisture barrier materials is the key to preventing water intrusion. Most water intrusion problems are related to the improper lapping of materials. Usually, flashing details around doors, windows, and penetrations are to blame. If the flashing details are right and the housewrap or building paper is properly installed, most moisture problems will be prevented. Capillary suction is a strong force and will move water in **any** direction. Even under conditions of light or no wind pressure, water can be wicked through seams, cracks, and joints upward behind the overlaps of horizontal siding. Proper lap distances and sealant help prevent water intrusion caused by wicking action.

## How a Redundant Moisture Barrier Works

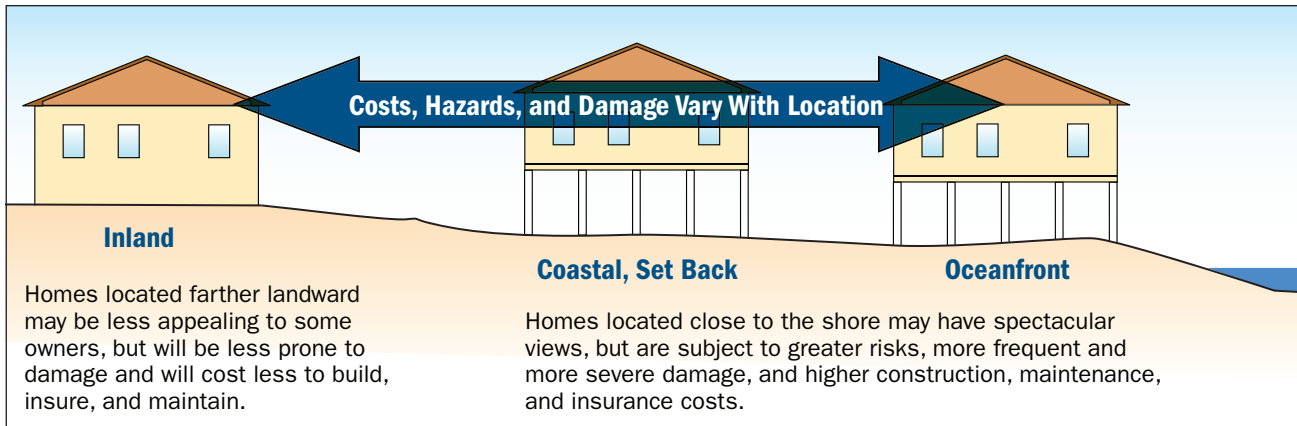


Developed in association with the National Association of Home Builders Research Center



# How Do Siting and Design Decisions Affect the Owner's Costs?

**Purpose:** To show the effects of planning, siting, and design decisions on coastal home costs.



## Key Issues

- When building a coastal home, initial, operating, and long-term costs (i.e., life cycle costs) must be considered.
- Coastal (especially oceanfront) homes cost more to design, construct, maintain, repair, and insure than inland homes.
- Determining the risks associated with a particular building site or design is important.
- Siting, designing, and constructing to minimum regulatory requirements do not necessarily result in the lowest cost to the owner over a long period of time. Exceeding minimum design requirements costs slightly more initially, but can save the owner money in the long run.

**Operating costs** include costs associated with the use of the building, such as the costs of utilities and insurance.<sup>1</sup>

**Long-term costs** include costs for preventive maintenance and for repair and replacement of deteriorated or damaged building components.

## Risk

One of the most important building costs to be considered is that resulting from storm and/or erosion damage. But how can an owner decide what level of risk is associated with a particular building site or design? One way is to consider the probability of a storm or erosion occurring and the potential building damage that results (see matrix).

## Costs

A variety of costs should be considered when planning a coastal home, not just the construction cost. Owners should be aware of each of the following, and consider how siting and design decisions will affect these costs:

**Initial costs** include property evaluation and acquisition costs and the costs of permitting, design, and construction.

Potential \$ Losses

		Probability of Occurrence		
		Low	Medium	High
Potential \$ Losses	Low	Low Risk	Low Risk	Medium Risk
	Medium	Low Risk	Medium Risk	High Risk
	High	Medium Risk	High Risk	Extreme Risk

<sup>1</sup>Note: Flood insurance premiums can be reduced up to 60 percent by exceeding minimum siting, design, and construction practices. See the V Zone Risk Factor Rating Form in FEMA's Flood Insurance Manual (<http://www.fema.gov/nfip/manual.shtm>).



**Building sites or designs resulting in extreme or high risk should be avoided** — the likelihood of building loss is great, and the long-term costs to the owner will be very high. Building sites or designs resulting in medium or low risk should be given preference.

### Siting

Note that over a long period, poor siting decisions are rarely overcome by building design.

### Design

- How much more expensive is it to build near the coast as opposed to inland areas? The table below suggests approximately 10 - 30 percent more.
- What about exceeding minimum design requirements in coastal areas? The table suggests that the added construction costs for meeting the practices recommended in the Home Builder's Guide to Coastal Construction (beyond typical minimum requirements) are nominal.

Design Item	Cross-Reference to Fact Sheets	Added Initial Costs <sup>2</sup> Required by Code or NFIP	Added Initial Costs <sup>3</sup> for Home Builder's Guide to Coastal Construction Recommended Practices	Effect of Design on Cost					
				Reduce wind/storm damage	Reduce flood damage	Longer material life	Reduce maintenance	Lower insurance	Lower utility bills
(Items with asterisk "*" are required by the National Flood Insurance Program (NFIP) and/or local building code.)									
A Zone, pile/column foundation	1.1, 1.4, 3.1	High	High	✓	✓		✓		
V Zone, pile/column foundation*	1.1, 1.4, 1.5, 3.1	High			✓		✓		
Joists sheathed on underside		Low	Low		✓	✓			✓
Structurally sheathed walls*		Medium		✓					
Corrosion protection*	1.1, 1.7	Low		✓	✓	✓	✓		
Decay protection*	1.1, 1.7	Medium		✓	✓	✓	✓		
Hip roof shape	1.1	Low	Low	✓					
Enhanced roof sheathing connection*	1.1, 7.1	Low	Low	✓					
Enhanced roof underlayment*	7.2	Low	Low	✓					
Upgraded roofing materials*	1.1, 7.3	Medium		✓		✓	✓		
Enhanced flashing*	1.1, 6.1, 5.2	Low		✓		✓	✓		
Housewrap*	1.1, 6.1, 5.1	Low		✓					✓
Superior siding and connection*	5.3	Medium	Medium	✓			✓		
Protected or impact-resistant glazing*	1.1, 6.2	High	Medium	✓				✓	
Connection hardware*	1.1, 1.7, 4.3	Low		✓	✓				
Flood-resistant materials*	1.1, 1.7	Low			✓	✓		✓	
Protected utilities and mechanicals*	1.1, 8.3	Low		✓	✓	✓	✓		✓
<b>Estimated Total Additional Cost (\$ thousands)</b>		<b>15-30</b>	<b>±5</b>	✓	✓	✓	✓	✓	✓

Low	<0.5% of base building cost	Estimates are based on a 3,000-square-foot home with a moderate number of windows and special features. Many of the upgraded design features are required by local codes, but the level of protection beyond the code minimum can vary, depending on the owner's preference.
Medium	0.5% - 2.0% of base building cost	
High	>2.0% of base building cost	

**Notes:**

- 2 Added costs when compared to typical inland construction
- 3 Added initial costs to exceed Code/NFIP minimum requirements

Developed in association with the National Association of Home Builders Research Center



# Selecting a Lot and Siting the Building

**Purpose:** *To provide guidance on lot selection and siting considerations for coastal residential buildings.*

## Key Issues

- Purchase and siting decisions should be long-term decisions, not based on present-day shoreline and conditions.
- Parcel characteristics, infrastructure, regulations, environmental factors, and owner desires constrain siting options.
- Conformance with local/state shoreline setback lines does not mean buildings will be “safe.”
- Information about site conditions and history is available from several sources.



Siting, design, and construction should be considered together (see Fact Sheet No. 2.1), but know that poor lot selection and siting decisions can rarely be overcome by improved design and construction. Building failures (see Fact Sheet No. 1.1) are often the result of poor siting.

## The Importance of Property Purchase and Siting Decisions

**The single most common and costly siting mistake made by designers, builders, and owners is failing to consider future erosion and slope stability** when an existing coastal home is purchased or when land is purchased and a new home is built. Purchase decisions—or siting, design, and construction decisions—based on present-day shoreline conditions often lead to future building failures.

Over a long period of time, owners of poorly sited coastal buildings may spend more money on erosion control and erosion-related building repairs than they spent on the building itself.

## What Factors Constrain Siting Decisions?

Many factors affect and limit a home builder's or owner's ability to site coastal residential buildings, but the most influential is probably **parcel size**, followed by **topography, location of roads and other infrastructure, regulatory constraints**, and **environmental constraints**.

Given the cost of coastal property, parcel sizes are often small and owners often build the largest building that will fit within the permissible development footprint. Buyers frequently fail to recognize that siting decisions in these cases have effectively been made at the time the land was platted or subdivided, and that shoreline erosion can render these parcels unsuitable for long-term occupation.

In some instances, however, parcel size may be large enough to allow a hazard-resistant coastal building to be sited and constructed, but an **owner's desire** to push the building as close to the shoreline as possible increases the likelihood that the building will be damaged or destroyed in the future.



## Coastal Setback Lines – What Protection Do They Provide?

Many states require new buildings to be sited at or landward of coastal construction setback lines, which are usually based on **long-term, average annual erosion rates**. For example, a typical minimum 50-year setback line with an erosion rate of 2.5 feet/year would require a setback of 125 feet, typically measured from a reference feature such as the dune crest, vegetation line, or high-water line.

Building at the 125-foot setback (in this case) does **not** mean that a building will be “safe” from erosion for 50 years.

- Storms can cause short-term erosion that far exceeds setbacks based on long-term averages.
- Erosion rates vary over time, and erosion could surpass the setback distance in just a few years’ time. The rate variability must also be known to determine the probability of undermining over a given time period.

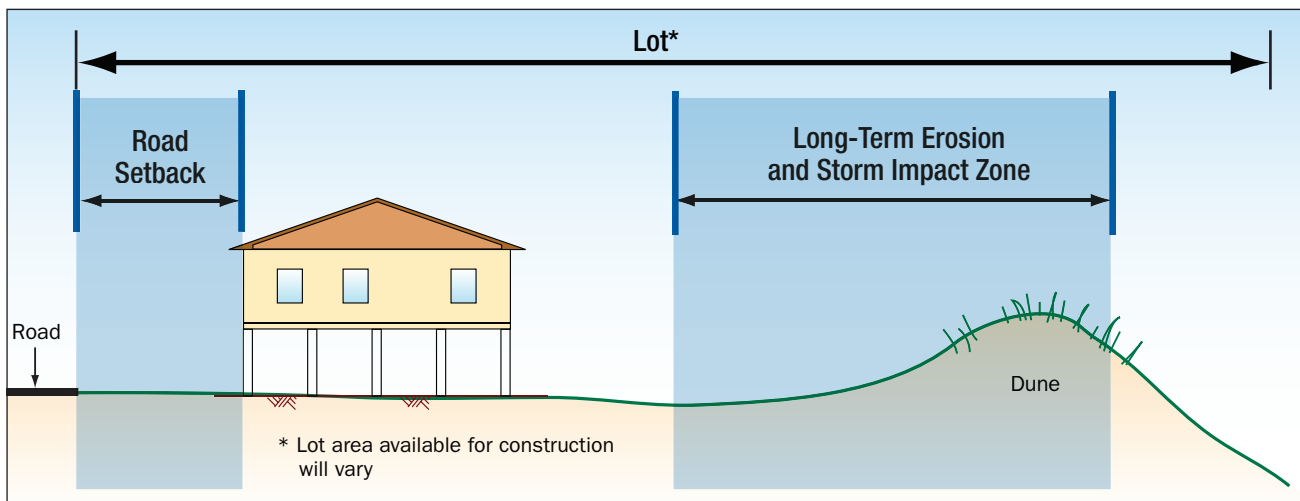
## What Should Builders, Designers, and Owners Do?

- Consult local and state agencies, universities, and consultants for detailed, site-specific erosion and hazard information.
- Look for historical information on erosion and storm effects. How have older buildings in the area fared over time? Use the experience of others to guide siting decisions.
- Determine the owner’s risk tolerance, and reject parcels or building siting decisions that exceed the acceptable level of risk.

## Common Siting Problems

- Building on a **small lot between a road and an eroding shoreline** is a recipe for trouble.
- **Odd-shaped lots** that force buildings close to the shoreline increase the vulnerability of the buildings.
- Siting a building near the **edge of a bluff** increases the likelihood of building loss, because of both bluff erosion and changes in bluff stability resulting from development activities (e.g., clearing vegetation, building construction, landscaping, changes in surface drainage and groundwater flow patterns).
- Siting near a **tidal inlet** with a dynamic shoreline can result in the building being exposed to increasing flood and erosion hazards over time.
- Siting a building **immediately behind an erosion control structure** may lead to building damage from wave overtopping and may limit the owner’s ability to repair or maintain the erosion control structure.
- Siting a new building **within the footprint** of a pre-existing building does not guarantee that the location is a good one.

*Siting should consider both long-term erosion and storm impacts. Siting should consider site-specific experience, wherever available.*



**Recommended building location on a coastal lot.**

Developed in association with the National Association of Home Builders Research Center





# Foundations in Coastal Areas

**Purpose:** *To describe foundation types suitable for coastal environments.*

## Key Issues

- Foundations in coastal areas should elevate buildings above the Design Flood Elevation (DFE) in accordance with ASCE 24-05, while withstanding flood forces, high winds, scour and erosion, and floating debris in ASCE 7-10.
- Foundations used for inland construction are generally not suitable for coastal construction. Some examples of foundation systems that have a history of poor performance in erosion prone areas are slab-on-ground, spread footings, and mat (or raft) foundations.
- Deeply embedded pile or column foundations are required for V Zone construction. In A Zones they are recommended instead of solid wall, crawlspace, slab, or other shallow foundations, which are more susceptible to scour. (For the reference of this document, the term deeply embedded means “sufficient penetration into the ground to accommodate storm-induced scour and erosion and to resist all design vertical and lateral loads without structural damage.”)
- Areas below elevated buildings in V Zones must be “free of obstructions” that can transfer flood loads to the foundation and building (see Fact Sheet No. 8.1, Enclosures and Breakaway Walls). Areas below elevated buildings in A Zones should follow the same recommended principles as those areas for buildings located in V Zones.



**Figure 1. Near collapse due to insufficient pile embedment in Dauphin Island, Alabama.**

(SOURCE: FEMA 549, HURRICANE KATRINA IN THE GULF COAST)

## Foundation Design Criteria

All foundations for buildings in flood hazard areas must be constructed with flood-damage-resistant materials (see Fact Sheet No. 1.7, Coastal Building Materials). In addition to meeting the requirements for conventional construction, these foundations must: (1) elevate the building above the Base Flood Elevation (BFE), and (2) prevent flotation, collapse, and lateral movement of the building, resulting from loads and conditions during the design flood event (in coastal areas, these loads and conditions include

inundation by fast-moving water, breaking waves, floating debris, erosion, and high winds).

Because the most hazardous coastal areas are subject to erosion, scour, and extreme flood loads, **the only practical way to perform these two functions is to elevate a building on a deeply embedded and “open” (i.e., pile or column) foundation.** This approach resists storm-induced erosion and scour, and it minimizes the foundation surface area subject to lateral flood loads.

ASCE 24-05 is recommended as a best practice for flood resistance design and construction, especially in V Zones and Coastal A Zones. This standard has specific information on foundation requirements for Coastal High Hazard Areas and Coastal A Zones and it has stricter requirements than the NFIP. Elevation on open foundations is required by the National Flood Insurance Program (NFIP) in V Zones (even when the ground elevation lies above the BFE) and is strongly recommended for Coastal A Zones. Some states and communities have formally adopted open foundation requirements for Coastal A Zone construction.

While using the approach of elevation of structures on pile foundations improves performance and



minimizes some effects, even a deeply embedded open pile foundation will not prevent eventual undermining and loss due to long-term erosion (see Fact Sheet No. 2.2, *Selecting a Lot and Siting the Building*).

## Performance of Various Foundation Types in Coastal Areas

There are many ways to elevate buildings above the BFE: fill, slab-on-grade, crawlspace, stemwall, solid wall, pier (column), and pile. Not all of these are suitable for coastal areas. In fact, several of them are prohibited in V Zones and are not recommended for A Zone construction in coastal areas (see Fact Sheet 1.2, *Summary of Coastal Construction Requirements and Recommendations for Flood Effects*).

**Pile:** Pile foundations are recommended for V Zones and Coastal A Zones. These open foundations are constructed with square or round, wood, concrete, or steel piles, driven or jetted into the ground, or set into augered holes. Critical aspects of a pile foundation include the pile size, installation method and embedment depth, bracing, and the connections to the elevated structure (see Fact Sheets Nos. 3.2, *Pile Installation* and 3.3, *Wood-Pile-to-Beam Connections*). Pile foundations with inadequate embedment will lead to building collapse. Inadequately sized piles are vulnerable to breakage by waves and debris.

**Fill:** Using fill as a means of providing structural support to buildings in V Zones is prohibited because it is susceptible to erosion. Also, fill must not be used as a means of elevating buildings in any other coastal area subject to erosion, waves, or fast-moving water. However, minor quantities of fill are permitted for landscaping, site grading (not related to

structural support of the building), drainage around and under buildings, and for the support of parking slabs, pool decks, patios and walkways (2009 IRC Section R322.3.2). These guidelines are consistent with NFIP Technical Bulletin 5, *Free-of-Obstruction Requirements for Buildings Located in Coastal High Hazard Areas (08/08)*, which states: “Fill must not prevent the free passage of floodwaters and waves beneath elevated buildings. Fill must not divert floodwaters or deflect waves such that increased damage is sustained by adjacent or nearby buildings.”

**Slab-on-Grade:** Slab-on-grade foundations are also susceptible to erosion and are prohibited in V Zones and are not recommended for A Zones in coastal areas. (Note that parking slabs are often permitted below elevated buildings, but are susceptible to undermining and collapse.) It is recommended that parking slabs be designed to be frangible (breakaway) or designed and constructed to be self-supporting structural slabs capable of remaining intact and functional under base flood conditions, including expected erosion. For more information, see NFIP Technical Bulletin 5, *Free-of-Obstruction Requirements for Buildings Located in Coastal High Hazard Areas (08/08)*.

**Crawlspace:** Crawlspace foundations are prohibited in V Zones and are not recommended for A Zone construction in coastal areas. They are susceptible to erosion when the footing depth is inadequate to prevent undermining. Crawlspace walls are also vulnerable to wave forces. Where used, crawlspace foundations must be equipped with flood openings; grade elevations should be such that water is not trapped in the crawlspace (see Fact Sheets Nos. 3.5, *Foundation Walls* and 8.1, *Enclosures and Breakaway Walls*).



**Figure 2. Performance comparison of pier foundations. Piers on discrete footings (foreground) failed by rotating and overturning while piers on more substantial footings (in this case a concrete mat) survived (Pass Christian, Mississippi)**

**Stemwall:** Stemwall foundations are similar to crawlspace foundations in construction, but the interior space that would otherwise form the crawlspace is often backfilled with structural fill or sand that supports a floor slab. Stemwall foundations have been observed to perform better during storms than many crawlspace and pier foundations. Although the IRC allows for heights of up to six feet, it is usually more economical and a better design choice to use another foundation system if stemwalls are over a few feet in height. During periods of high water backfill, soils may become flooded and cause damage to the slab. The designer should ensure that this does not cause consolidation of the backfill. In addition, in some soils such as sand, capillary action can cause water and moisture to affect the slab. Flood openings are not required in a backfilled stemwall foundation. Stemwall foundations are

prohibited in V Zones but are recommended in A Zone areas subject to limited wave action, as long as embedment of the wall is sufficient to resist erosion and scour (see FEMA 549, *Hurricane Katrina in the Gulf Coast*).

**Solid Foundation Walls:** The NFIP prohibits solid foundation walls in V Zones and are not recommended for A Zone areas subject to breaking waves or other large flood forces—the walls act as an obstruction to flood flow. Like crawlspace walls, they are susceptible to erosion when the footing depth is inadequate to prevent undermining. Solid walls have been used in some regions to elevate buildings one story in height. Where used, the walls must allow floodwaters to pass between or through the walls (using flood openings). (See Fact Sheets Nos. 3.5, *Foundation Walls* and 8.1, *Enclosures and Breakaway Walls*.)

**Pier (column):** Pier foundations are recommended for A Zone areas where erosion potential and flood forces are small. This open foundation is commonly constructed with reinforced and grouted masonry units atop a concrete footing. Shallow pier foundations are extremely vulnerable to erosion and overturning if the footing depth and size are inadequate. They are also vulnerable to breakage. Fact Sheet No. 3.4, *Reinforced Masonry Pier Construction*, provides guidance on how to determine whether pier foundations are appropriate, and how to design and construct them.

### Foundations for High-Elevation Coastal Areas

Foundation design is problematic in bluff areas that are vulnerable to coastal erosion but outside mapped flood hazard areas. Although NFIP requirements may not apply, the threat of undermining is not diminished.

Moreover, both shallow and deep foundations will fail in such situations. Long-term solutions to the problem may involve better siting (see Fact Sheet No. 2.2, *Selecting a Lot and Siting the Building*), moving the building when it is threatened, or (where permitted and economically feasible) controlling erosion through slope stabilization and structural protection. Additionally FEMA 232, *Homebuilders' Guide to Earthquake Resistant Design and Construction*, provides information on foundation anchorage for hillside structures.

## Foundations in V Zones with Ground Elevations Above the BFE

In some instances, coastal areas will be mapped on an NFIP Digital Flood Insurance Rate Map (DFIRM) as Zone V, but will have dunes or bluffs with ground elevations above the BFE shown on the DFIRM. During a design flood event, erosion of the bluffs and high dunes can be expected at these areas as well as waves and inundation. Therefore, the ground level can be expected to be lowered to a point that wave forces and loss of soil are a critical factor. The foundations for structures in these V Zone areas with high ground elevation are the same as V Zone areas with lower ground elevations. Deeply embedded pile or column foundations are still required in these areas, and solid or shallow foundations are still prohibited. The presence of a V Zone designation in these instances indicates that the dune or bluff is expected to erode during the base flood event and that V Zone wave conditions are expected after the erosion occurs. The presence of ground elevations above the BFE in a V Zone should not be taken to mean that the area is free from base flood and erosion effects.

### Additional Resources

FEMA 550, *Recommended Residential Construction for the Gulf Coast: Building on Strong and Safe Foundations* (July 2006). (<http://www.fema.gov/library/viewRecord.do?id=1853>)

FEMA 549, *Hurricane Katrina in the Gulf Coast* (July 2006). (<http://www.fema.gov/library/viewRecord.do?id=1857>)

FEMA, NFIP Technical Bulletin 5, *Free-of-Obstruction Requirements for Buildings Located in Coastal High Hazard Areas*, FIA-TB-5, Washington, DC, August 2008. (<http://www.fema.gov/library/viewRecord.do?id=1718>)

FEMA 232, *Homebuilders' Guide to Earthquake Resistant Design and Construction*, Washington, DC, February 2001 (<http://www.fema.gov/library/viewRecord.do?id=2103>)

American Society of Civil Engineers (ASCE/SEI) Standard 7-10: *Minimum Design Loads for Buildings and Other Structures*, ASCE 7-10, (<http://www.asce.org>)

American Society of Civil Engineers (ASCE). *Flood Resistant Design and Construction*, ASCE/SEI 24-05. (<http://www.asce.org>)

Developed in association with the National Association of Home Builders Research Center





# Pile Design and Installation

**Purpose:** *To provide basic information about pile design and installation.*

## Key Factors

- Use a pile type that is appropriate for local conditions.
- Piles should resist coastal hazards such as high winds and flood loads in addition to withstanding erosion and scour. Erosion being the widespread loss of soil and scour being a localized loss of soil around a building or foundation element due to turbulent water movement.
- Have a registered engineer design piles for adequate layout, size, and length.
- Use installation methods that are appropriate for the conditions.
- Brace piles properly during construction.
- Make accurate field cuts, and treat all cuts and drilled holes to prevent decay.
- Have all pile-to-beam connections engineered, and use corrosion-resistant hardware (see Fact Sheet No. 1.7, *Coastal Building Materials*).

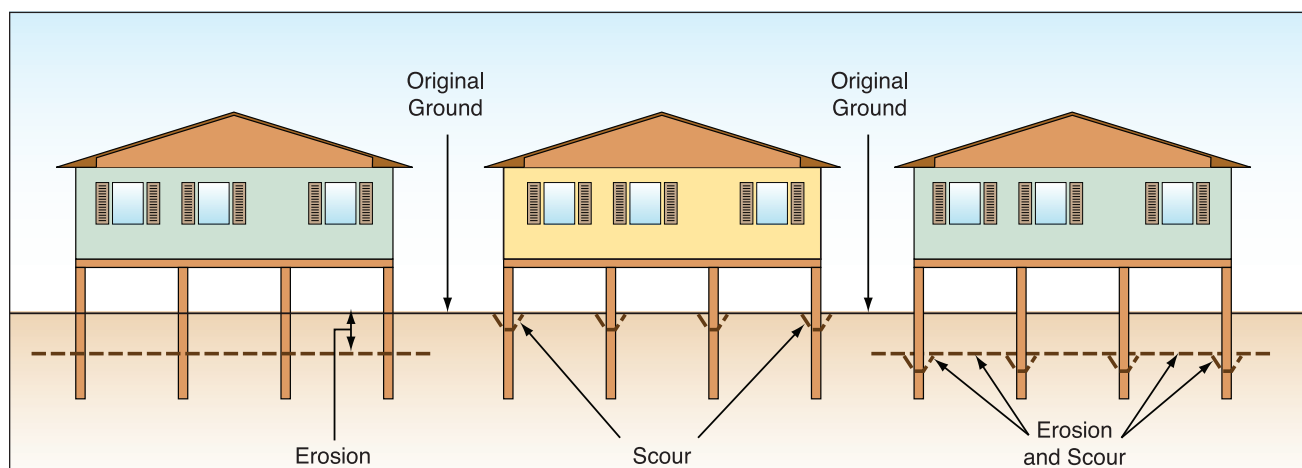
## Pile Types

The most common pile types used are preservative treated wood, concrete, and steel. Contractors doing construction in coastal areas typically select preservative treated wood piles for pile foundations. They can be square or round in cross section. Wood piles

are easily cut and adjusted in the field. Concrete and steel can also be used but are less common in residential construction. Concrete piles—may be an appropriate choice depending upon the pile capacity requirements and elevation needed by the design—are available in longer lengths and are usually installed by pile driving. Concrete piles tend to have higher strengths and are durable to many factors that are in the coastal environment when properly designed and detailed. Steel piles are rarely used because of potential corrosion problems.

## Pile Size and Length

The foundation engineer is the one who determines pile size and length. Specified bearing and penetration requirements must be met. Round piles should have no less than an 8-inch tip diameter; square piles should have a minimum timber size of 8 by 8 inches. The total length of the pile is based on building code requirements [see the 2009 International Building Code (IBC) Section 1810 on deep foundations], calculated penetration requirements, erosion and scour potential, Design Flood Elevation (DFE), and allowance for cut-off and beam width (see Figure 1 and Table 1, which is an example of foundation design results). Substantial improvement in foundation performance can be achieved by increasing the minimum timber size for square piles to 12 by 12 inches or minimum tip diameter for round piles of 12 inches.



**Figure 1. Distinguishing between coastal erosion and scour. A building may be subject to either or both, depending on the building location, soil characteristics, and flood conditions.**



**Table 1. Example foundation adequacy calculations for a two-story house supported on square timber piles and situated away from the shoreline, storm surge, and broken waves passing under the building, 130-mph basic wind speed per ASCE 7-05 (167-mph equivalent ASCE 7-10 basic wind speed for Risk Category II buildings), soil = medium dense sand. Shaded cells indicate the foundation fails to meet bending (P) and/or embedment (E) requirements.**

Pile Embedment Before Erosion and Scour	Erosion and Scour Conditions	Pile Diameter, Ø		
		8 inch	10 inch	12 inch
10 feet	Erosion = 0, Scour = 0	P, E	E	OK
	Erosion = 0, Scour = 2.0Ø	P, E	E	E
	Erosion = 1, Scour = 2.5Ø	P, E	E	E
	Erosion = 1, Scour = 3.0Ø	P, E	E	E
	Erosion = 1, Scour = 4.0Ø	P, E	P, E	E
15 feet	Erosion = 0, Scour = 0	P	OK	OK
	Erosion = 0, Scour = 2.0Ø	P	OK	OK
	Erosion = 1, Scour = 2.5Ø	P	OK	OK
	Erosion = 1, Scour = 3.0Ø	P	OK	OK
	Erosion = 1, Scour = 4.0Ø	P, E	P, E	E
20 feet	Erosion = 0, Scour = 0	P	OK	OK
	Erosion = 0, Scour = 2.0Ø	P	OK	OK
	Erosion = 1, Scour = 2.5Ø	P	OK	OK
	Erosion = 1, Scour = 3.0Ø	P	OK	OK
	Erosion = 1, Scour = 4.0Ø	P	P	OK

### Pile Layout

The foundation engineer and designer determine the pile layout together. Accurate placement and correction of misaligned piles is important. The use of a drive template for guiding the pile driving operation greatly increases the accuracy of the pile location and need for difficult remediation. A drive template is a temporary guide structure that is installed in a manner to restrict the lateral movement of the piles during driving. The pile template is reused for each row of piles to assure consistent spacing and alignment. Pile placement should not result in more than 50 percent of the pile cross section being cut for girder or other connections. Verify proper pile locations on drawings before construction and clarify any discrepancies. Layout can be done by a licensed design professional or surveyor, a construction surveyor, the foundation contractor, or the builder. The layout process must always include establishing an elevation for the finished first floor. Construction of the first-floor platform should not begin until this elevation is established (see Fact Sheet No. 1.4, *Lowest Floor Elevation*).

### Installation Methods

Piles can be driven, augered, or jetted into place. The installation method will vary with soil conditions, bearing requirements, equipment available, and local practice. One common method is to initially jet the pile to a few feet short of required penetration, then complete the installation by driving with a drop

hammer. Driving the pile even a few feet helps assure the pile is achieving some end-bearing capacity and some skin friction. Full depth driving where achievable provides for a pile foundation that has several advantages that merit consideration.

### Pile Bracing

The engineer determines pile bracing layout. Common bracing methods include knee and diagonal bracing. Knee bracing is an effective method of improving the performance of a pile system without creating an obstruction to the flow of water and debris from a design event. Because slender bracing is susceptible to buckling, slender bracing should be considered as tension only. Bracing can become an obstruction, however, and increase a foundations exposure to wave and debris impact. Bracing is often oriented perpendicular to the shoreline so that it is not struck broadside by waves, debris, and velocity flow (see Figure 2). Temporary bracing or jacking to align piles and hold true during construction is the responsibility of the contractor.

It is recommended that pile bracing be used only for reducing the structure’s sway and vibration for comfort. In other words, bracing should be used to address serviceability issues and not strength issues. The foundation design should consider the piles as being un-braced as the condition that may occur when floating debris removes or damages the bracing. If the pile foundation is not able to provide

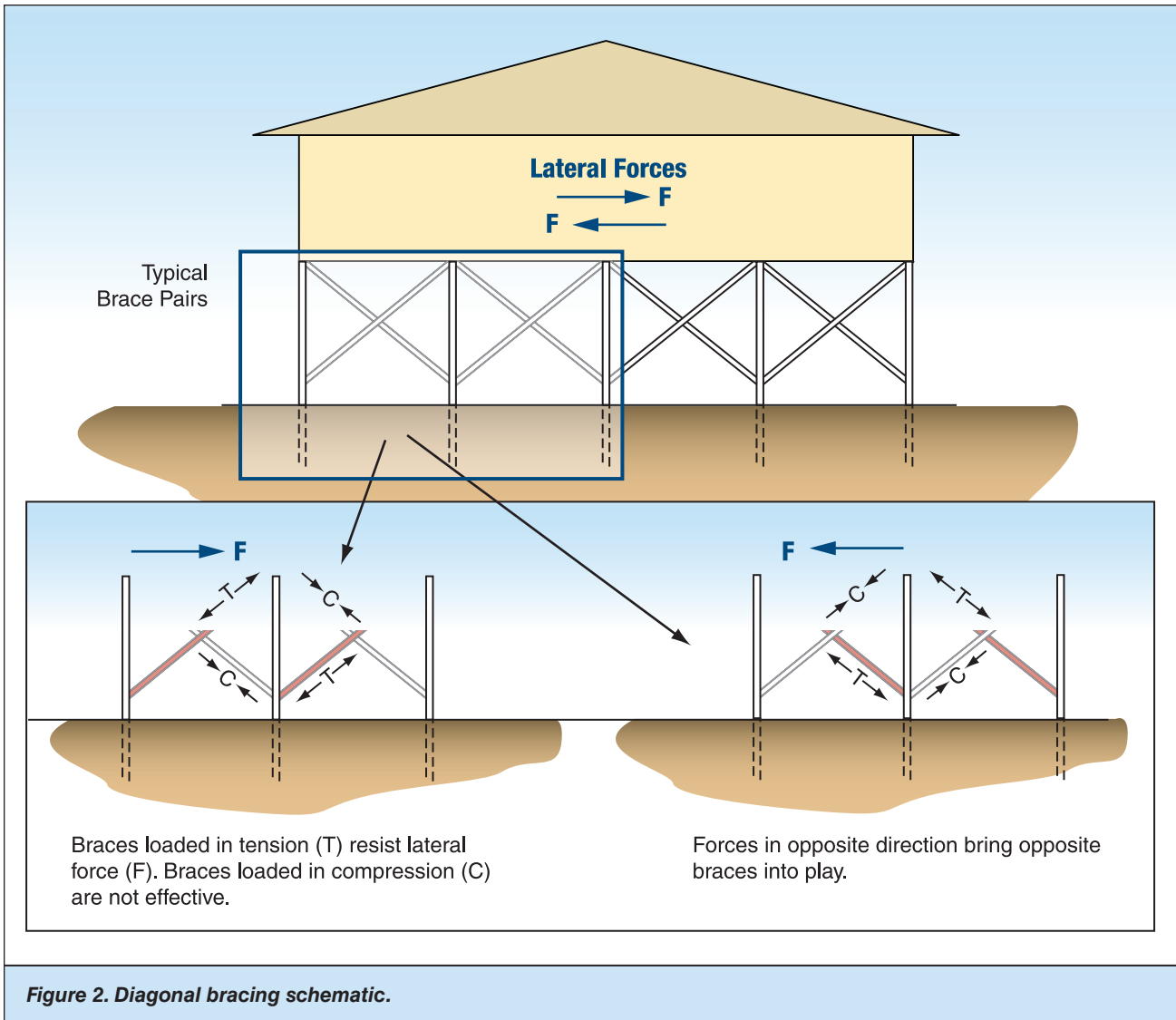


Figure 2. Diagonal bracing schematic.

the desired strength performance without bracing then the designer should consider increasing the pile size. Pile bracing should only be for comfort of the occupants, but not for stability of the home.

### Field Cutting and Drilling

A chain saw is the common tool for making cuts and notches in wood piles. After making cuts, exposed areas should be field-treated with the proper wood preservative to prevent decay. This involves applying the preservative with a brush to the cut or drilled holes in the pile until no more fluid is drawn into the wood.

### Connections

The connection of the pile to the structural members is one of the most critical connections in the structure. Always follow design specifications and use corrosion-resistant hardware. Strict attention to

detail and good construction practices are critical for successful performance of the foundation (see Fact Sheet Nos. 1.7, *Coastal Building Materials*, and 3.3, *Wood-Pile-to-Beam Connections*).

### Verification of Pile Capacity

Generally, pile capacity for residential construction is not verified in the field. If a specified minimum pile penetration is provided, bearing is assumed to be acceptable for the local soil conditions. Subsurface soil conditions can vary from the typical assumed conditions, so verification of pile capacity is prudent, particularly for expensive coastal homes. Various methods are available for predicting pile capacity. Consult a local foundation engineer for the most appropriate method for the site.

## Additional Resources

American Concrete Institute (ACI), 543R-00: *Design, Manufacture, and Installation of Concrete Piles* (Reapproved 2005), (<http://www.concrete.org>)

American Forest and Paper Association (AF&PA). *National Design Specification for Wood Construction*. (<http://www.afandpa.org>)

American Society for Testing and Materials (ASTM). *Standard Specification for Round Timber Piles*, ASTM D25. (<http://www.astm.org>)

American Wood-Preservers Association (AWPA). *All Timber Products – Preservative Treatment by Pressure Processes*, AWWA C1-00; *Lumber, Timber, Bridge Ties and Mine Ties – Preservative Treatment by Pressure Processes*, AWWA C2-01; *Piles – Preservative Treatment by Pressure Process*, AWWA C3-99; and others. (<http://www.awpa.com>)

Pile Buck, Inc. *Coastal Construction*. (<http://www.pilebuck.com>)

Southern Pine Council (SPC) (<http://www.southernpine.com/about.shtml>)

Timber Pile Council, American Wood Preservers Institute, *Timber Pile Design and Construction Manual*, (<http://www.wwpinstitute.org/pdffiles/TimberPileManual.pdf>)



# Wood Pile-to-Beam Connections

**Purpose:** To illustrate typical wood pile-to-beam connections, provide basic construction guidelines on various connection methods, and show pile bracing connection techniques.

## Key Issues

- Verify pile alignment and correct, if necessary, before making connections.
- Carefully cut piles to ensure required scarf depths.
- Limit cuts to no more than 50 percent of pile cross section.
- Use corrosion-resistant connectors and fasteners such as those fabricated from stainless steel, or connectors and fasteners with corrosion protection such as provided by hot-dip galvanized coating (see Fact Sheet No. 1.7, *Coastal Building Materials*).
- Accurately locate and drill bolt holes.
- Field-treat all cuts and holes to prevent decay.
- Use sufficient pile and beam sizes to allow proper bolt edge distances.

Built-up beams should be designed as continuous members and not be broken over the piles. Some homebuilders are using engineered wood products, such as glued laminated timber and parallel strand lumber, which can span longer distances without splices. The ability to span longer distances without splices eases installation and reduces fabrication costs.

**Note:** Pile-to-beam connections must be designed by an engineer.

Figure 1. Pile-to-beam bolted connection.

### Pile-to-beam connections must:

1. Provide required **bearing** area for beam to rest on pile.
2. Provide required **uplift** (tension) resistance.
3. Maintain beam in an **upright** position.
4. Be capable of resisting **lateral** loads (wind and seismic).
5. Be constructed with **durable** connectors and fasteners from corrosion-resistant materials or with corrosion protection in accordance with minimum requirements of the International Residential Code. The level of corrosion protection that can be expected will vary depending on the type of wood treatment and fastener type. Make sure the fastener is compatible with the wood variety selected for construction.

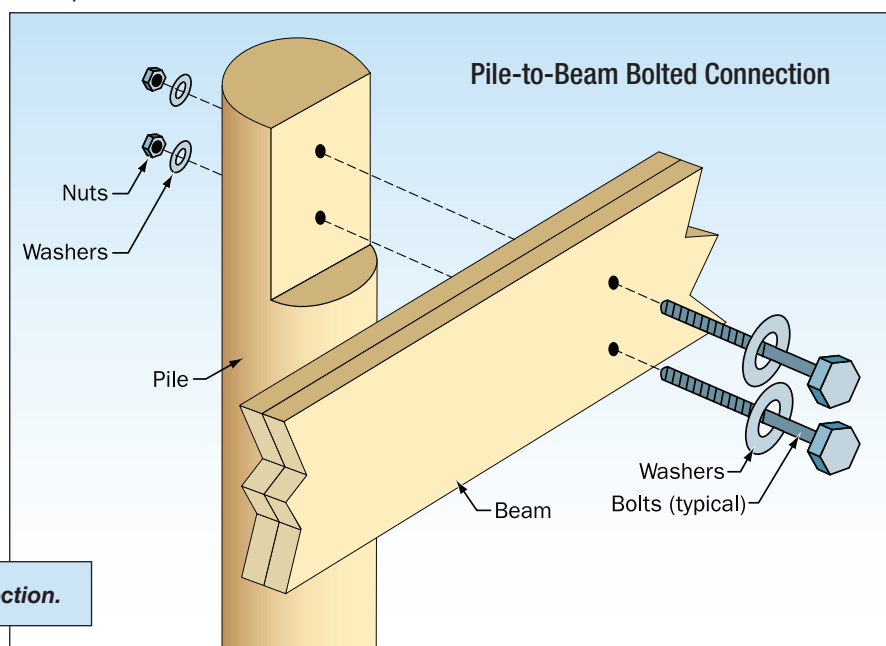
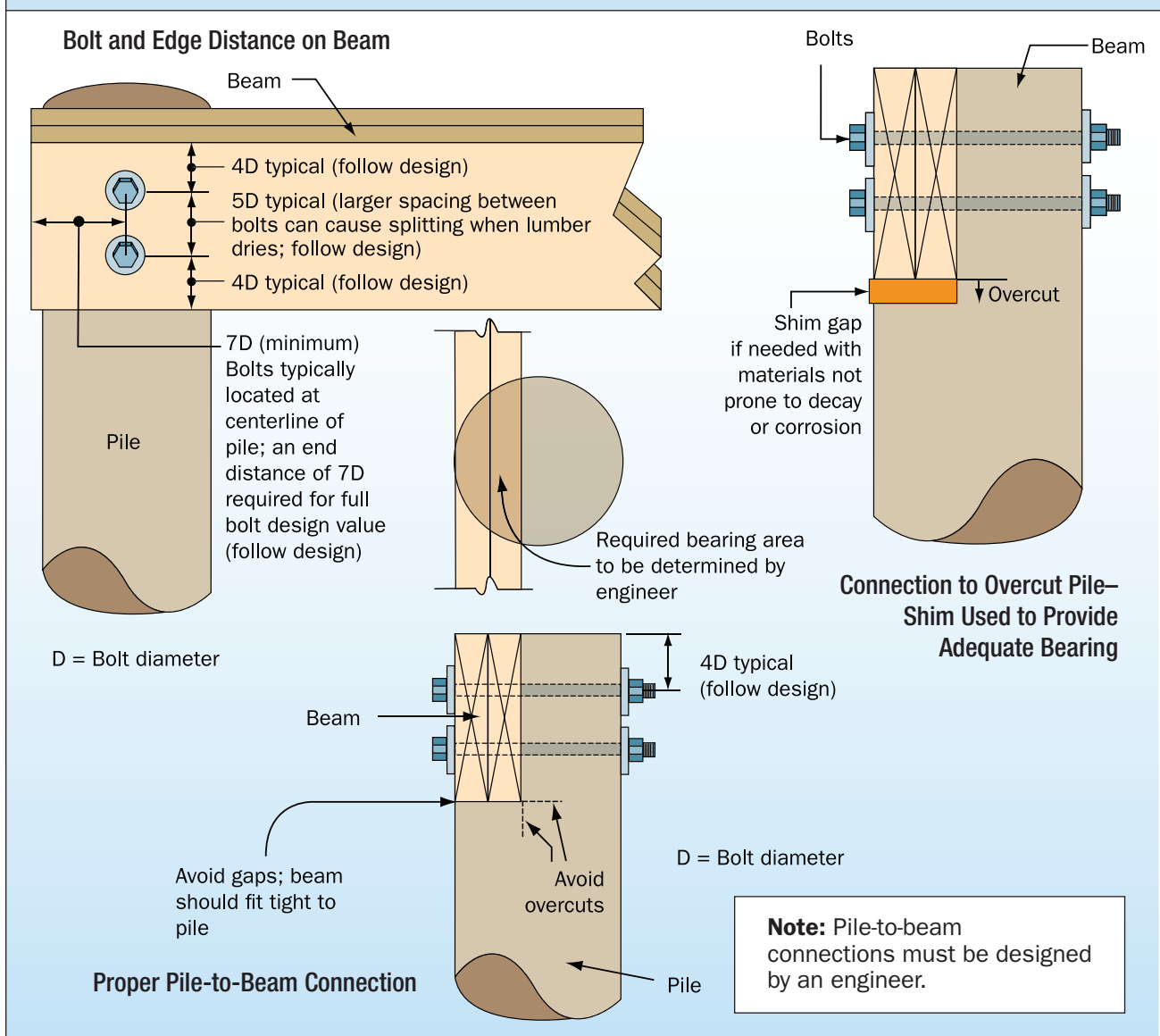


Figure 2. Proper pile-to-beam bolted connection.



**Problem:** misaligned piles—some piles are shifted in or out from their intended (design) locations.

**There are five possible solutions to fix the problem. (See figure 3 and details in figure 4):**

**Option 1** – beam cannot be shifted.

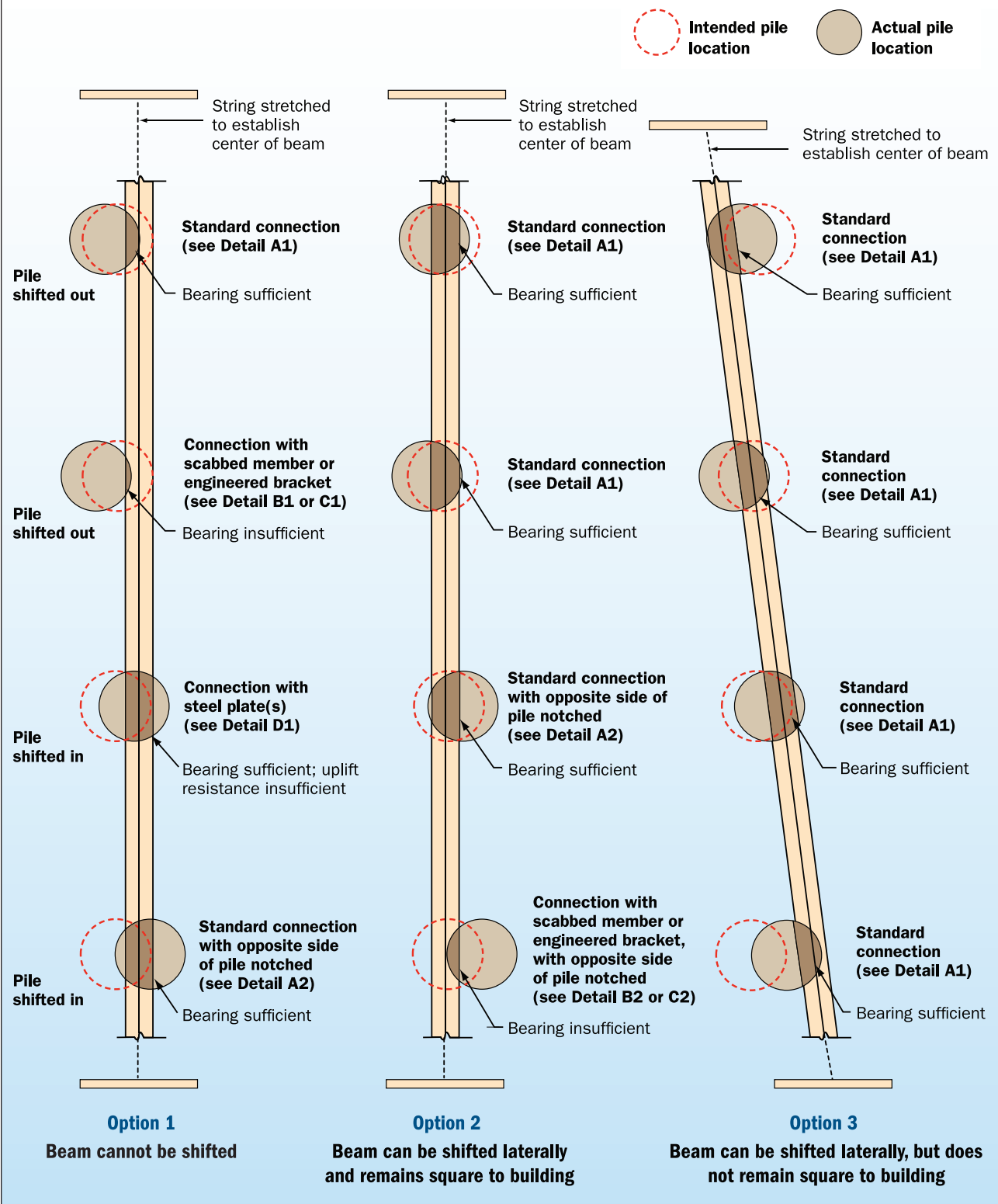
**Option 2** – beam can be shifted laterally and remains square to building.

**Option 3** – beam can be shifted laterally, but does not remain square to building.

**Option 4 (not shown)** – beam cannot be shifted, and connections shown in this fact sheet cannot be made; install and connect sister piles; an engineer must be consulted for this option.

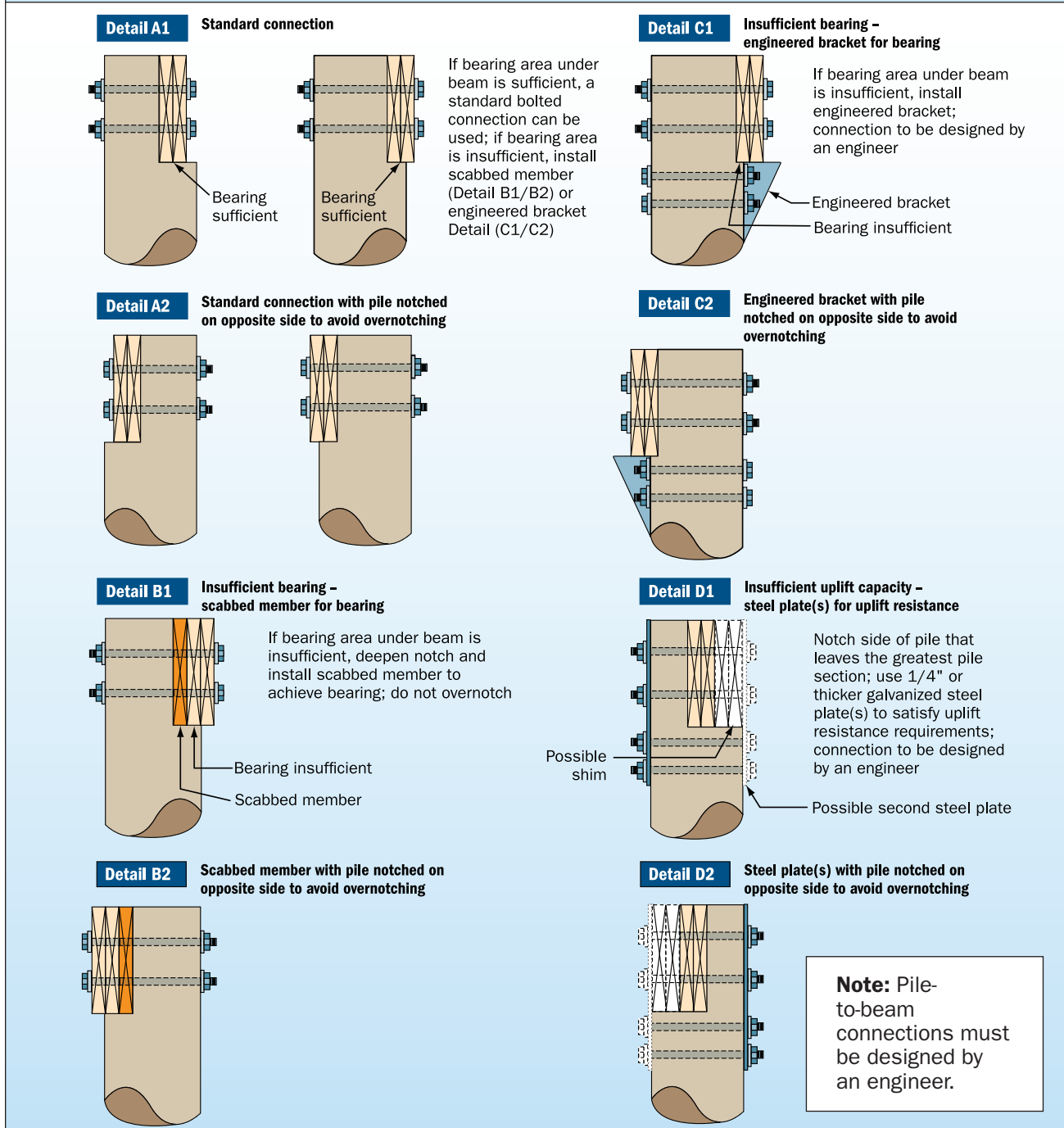
**Option 5 (not shown)** – beam cannot be shifted, and connections shown in this fact sheet cannot be made; remove and reinstall piles, as necessary.

Figure 3. Connection of misaligned pile.



**Note:** Pile-to-beam connections must be designed by an engineer.

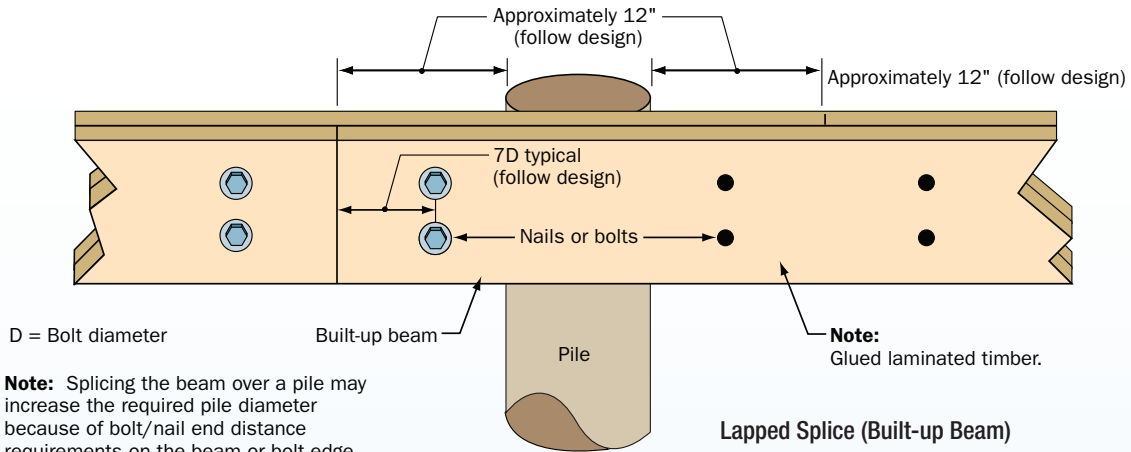
Figure 4. Connection details for misaligned piles.



**Connections to misaligned piles (see drawings on figure 3 and details above)**

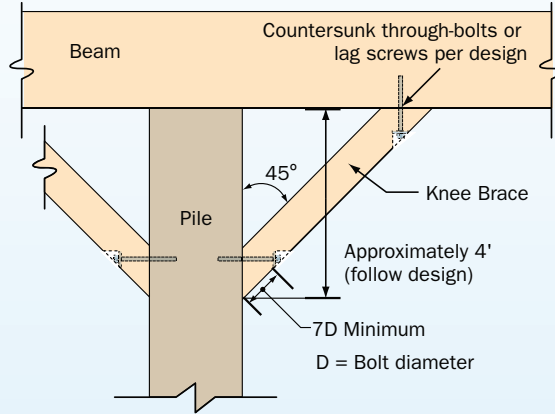
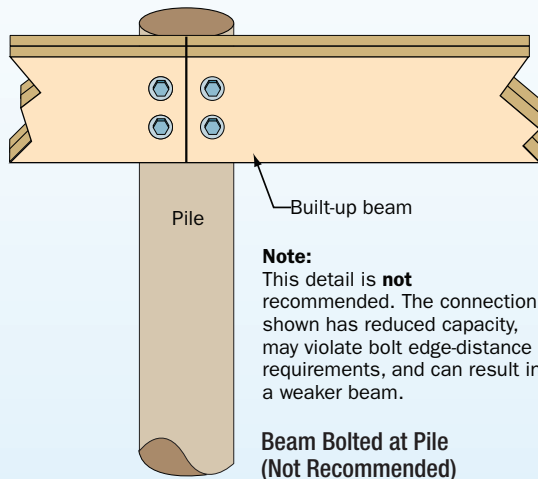
1. The ability to construct the pile-to-beam connections designed by the engineer is directly dependent upon the accuracy of pile installation and alignment.
2. Misaligned piles will require the contractor to modify pile-to-beam connections in the field.
3. Badly misaligned piles will require removal and reinstallation, sister piles, or special connections, all to be determined by the engineer.

Figure 5. Built-up beam connections, knee brace connections, and diagonal brace connections.



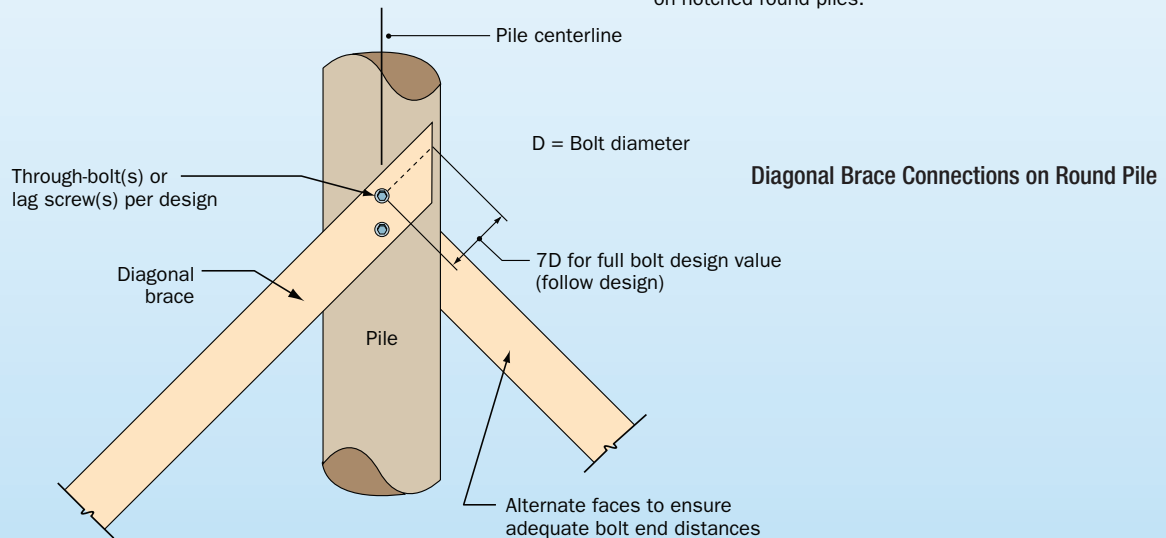
D = Bolt diameter

**Note:** Splicing the beam over a pile may increase the required pile diameter because of bolt/nail end distance requirements on the beam or bolt edge distance requirements on the pile.



Knee Brace Connection on Square Pile\*

\*Knee braces of this type can also be used on notched round piles.



**Note:** Pile-to-beam connections must be designed by an engineer.

## Additional Resources

American Wood Council (AWC) (<http://www.awc.org>)

American Institute of Timber Construction (AITC) (<http://www.aitc-glulam.org>)

*Developed in association with the National Association of Home Builders Research Center*

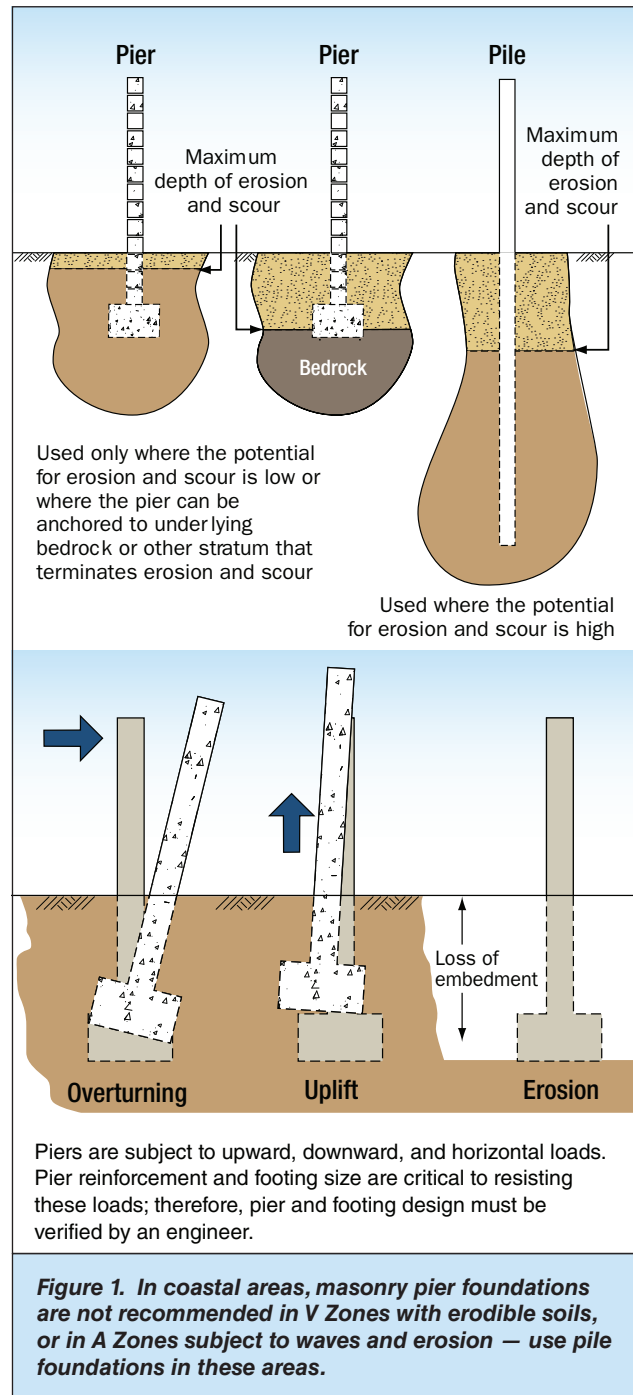


# Reinforced Masonry Pier Construction

**Purpose:** To provide an alternative to piles in V Zones and A Zones in coastal areas where soil properties and other site conditions indicate that piers are an acceptable alternative to the usually recommended pile foundation. Examples of appropriate conditions for the use of piers are where rock is at or near the surface or where the potential for erosion and scour is low.

## Key Issues

- The footing must be designed for the soil conditions present. Pier foundations are generally not recommended in V Zones or in A Zones in coastal areas.
- The connection between the pier and its footing must be properly designed and constructed to resist separation of the pier from the footing and overturning due to lateral (flood, wind, debris) forces.
- The top of the footing must be below the anticipated erosion and scour depth.
- The piers must be reinforced with steel and fully grouted.
- The connection to the floor beam at the top of the pier must be through use of properly sized and detailed metal connectors.
- Special attention must be given to the application of mortar and the tooling of all the joints in order to help resist water intrusion into the pier core, where the steel can be corroded.
- Special attention must be given to corrosion protection of joint reinforcement, accessories, anchors, and reinforcement bars. Joint reinforcement that is exposed to weather or the earth shall be stainless steel, hot dipped galvanized, or epoxy coated. Wall ties, plates, bars, anchors, and inserts exposed to earth or weather shall also be stainless steel, hot dipped galvanized, or epoxy coated. Reinforcement bars shall be protected by proper use of masonry cover.



## Piers vs. Piles

Pier foundations are most appropriate in areas where:

- Erosion and scour potential are low.
- Flood depths and lateral forces are low.
- Soil can help resist overturning of pier.

The combination of high winds and moist (sometimes salt-laden) air can have a damaging effect on masonry construction by forcing moisture into even the smallest of cracks or openings in the masonry joints. The entry of moisture into reinforced masonry construction can lead to corrosion of the steel reinforcement bars and subsequent cracking and spalling of the masonry. Moisture resistance is highly influenced by the quality of the materials and the quality of the masonry construction at the site.

## Good Masonry Practice

If a masonry pier is determined to be an appropriate foundation for a building, there are some practices that should be followed during construction of the piers.

- Masonry units and packaged mortar and grout materials should be stored off the ground and covered.
- Masonry work in progress must be well protected from exposure to weather.
- Mortar and grouts must be carefully batched and mixed. The 2009 International Building Code (IBC 2009) and 2009 International Residential Code (IRC) specify grout proportions by volume for masonry construction.
- Connectors should be selected that are appropriate for masonry to wood connection. It is important to maintain a sufficient load path from the building into the ground. The connectors and fasteners should be a corrosion-resistant material or have corrosion protection at least equivalent to that provided by coatings in accordance with the 2009 IRC. Connectors should be properly embedded or attached to the pier. Wood in contact with masonry pier should be naturally durable or preservative-treated. Figure 3 illustrates the importance of maintaining a proper load path between the pier and the building's beams.
- Properly sized steel reinforcing bars should be installed throughout the masonry piers. Piers should be fully grouted and steel reinforcing bars



Figure 2. Pier breakage (Long Beach, Mississippi)

should not be left exposed to weather for excessive amounts of time prior to installation. Lap splices should be properly located and of sufficient length to meet the standard masonry industry details and requirements to sufficiently carry the loads imposed on the structure.

- Consider incorporating grade beams into the foundation in order to achieve greater structural stability in the pier system.
- If the design of the pier system or any details are unclear, contact a structural engineer or appropriate design professional to clarify the foundation details.

## Pros and Cons of Grade Beams

Grade beams are horizontal structural members cast against the ground or “grade.” Grade beams can be a useful foundation method in areas with limited potential for erosion and scour. The type of force resisted by grade beams varies by application, but can range from continuous vertical and horizontal loads to axial loads. The grade beams used in this example are used primarily for axial loads generated by stability demands of the piers. The grade beams should be placed below the elevation of anticipated eroded grade so that there is no effect on scour and erosion of the supporting soils.

The pros of using grade beams with pier foundations are that they:

- Provide vertical and lateral support.
- Are less prone to rotation and overturning.
- Transfer loads imposed on the elevated home and foundation to the ground below.



Some cons of using grade beams with pier foundations are that they:

- Are susceptible to erosion and scour if too shallow
- Can become obstructions during flood events and can increase scour

### Are grade beams allowed in the V Zone?

Yes, although the NFIP states that the **lowest horizontal structural member** is to be constructed above the BFE, it is referring to the **lowest horizontal structural member** above **erodible** grade. Based on this, both grade beams, cross bracing and knee bracing are allowed by the NFIP. Grade beams can provide significant structural support to an open foundation system provided they are placed **below the expected eroded surface**.

**Figure 3. Failure of pier-to-beam connections due to wave and flood forces acting on the elevated building (Long Beach, Mississippi)**



### Additional Resources

American Concrete Institute, 2004, SP-66(04): *ACI Detailing Manual*. (<http://www.concrete.org>)

Concrete Reinforcing Steel Institute. *Placing Reinforcing Bars – Recommended Practices*, PRB-2-99. (<http://www.crsi.org>)

International Code Council. *International Building Code*. 2009. (<http://www.iccsafe.org>)

International Code Council. *International Residential Code*. 2009. (<http://www.iccsafe.org>)

The Masonry Society. 2008. *Building Code Requirements for Masonry Structures*. TMS 402-08/ACI 530-08/ASCE 5-08. (<http://www.masonrysociety.org>)

The Masonry Society. 2008. *Specifications for Masonry Structures*. TMS 402-08/ACI 530.1 08/ASCE 6-08. (<http://www.masonrysociety.org>)

Developed in association with the National Association of Home Builders Research Center





# Foundation Walls

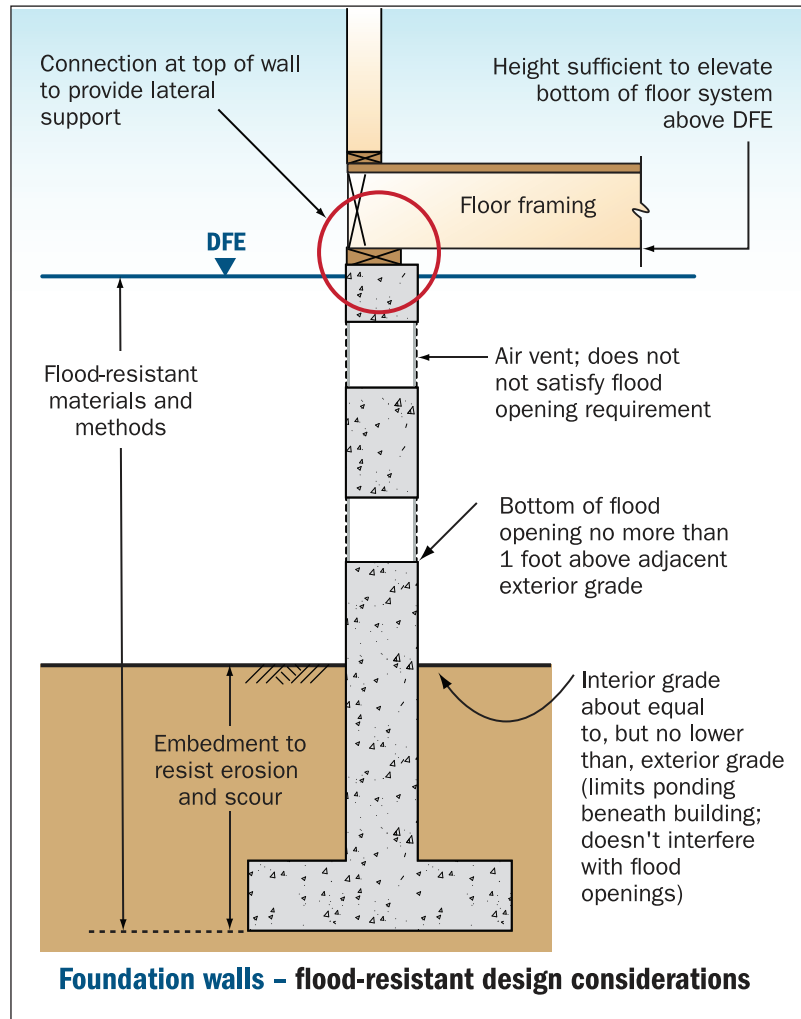
**Purpose:** To discuss the use of foundation walls in coastal buildings.

## Key Issues

- Foundation walls include stem-walls, cripple walls, and other solid walls.
- Foundation walls are prohibited by the National Flood Insurance Program (NFIP) in Zone V.\*
- Use of foundation walls in Zone A in coastal areas should be limited to locations where only shallow flooding occurs, and where the potential for erosion and breaking waves is low.
- Where foundation walls are used, flood-resistant design of foundation walls must consider embedment, height, materials and workmanship, lateral support at the top of the wall, flood openings and ventilation openings, and interior grade elevation.

## Foundation Walls – When Are They Appropriate?

Use of foundation walls – such as those in crawlspace and other solid-wall foundations – is potentially troublesome in coastal areas for two reasons: (1) they present an obstruction to breaking waves and fast-moving flood waters, and (2) they are typically constructed on shallow footings, which are vulnerable to erosion. For these reasons, **their use in coastal areas should be limited to sites subject to shallow flooding, where erosion potential is low and where breaking waves do not occur during the Base Flood.** The NFIP prohibits the use of foundation walls in Zone V\*. This *Home Builder's Guide to Coastal Construction* recommends against their use in Zone A in coastal areas. **Deeply embedded pile or column foundations are recommended** because they present less of an obstruction to floodwaters and are less vulnerable to erosion.



\* Note that the use of shearwalls below the Design Flood Elevation (DFE) may be permitted in limited circumstances (e.g., lateral wind/seismic loads cannot be resisted with a braced, open foundation. In such cases, minimize the length of shearwalls and the degree of obstruction to floodwaters and waves, orient shearwalls parallel to the direction of flow/waves, do not form enclosures). Consult the authority having jurisdiction for guidance concerning shearwalls below the DFE.



## Design Considerations for Foundation Walls

The design of foundation walls is covered by building codes and standards (e.g., Standard for Residential Construction in High-Wind Regions, ICC 600-2008, by the International Code Council). For flood design purposes, there are six additional design considerations: (1) embedment, (2) height, (3) materials and workmanship, (4) lateral support at the top of the wall, (5) flood openings and ventilation openings, and (6) interior grade elevation.

**Embedment** – The top of the footing should be no higher than the anticipated depth of erosion and scour (this basic requirement is the same as that for piers; see figure at right and Fact Sheet No. 3.4). If the required embedment cannot be achieved without extensive excavation, consider a pile foundation instead.

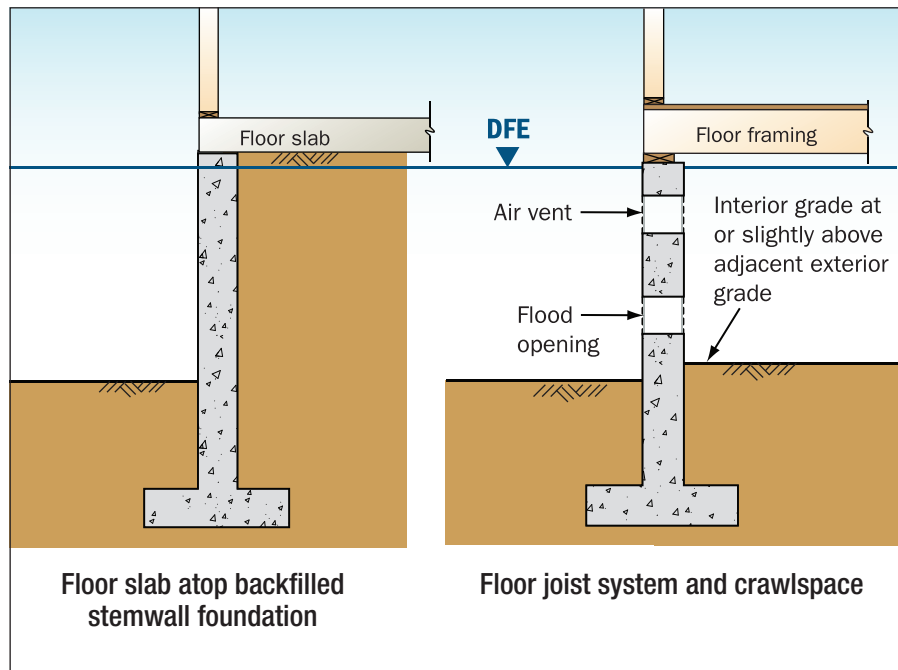
**Height** – The wall should be high enough to elevate the bottom of the floor system to or above the DFE (see Fact Sheet No. 1.4).

**Materials and Workmanship** – Foundation walls can be constructed from many materials, but masonry, concrete, and wood are the most common. Each material can be specified and used in a manner to resist damage due to moisture and inundation (see Fact Sheet No. 1.7). Workmanship for flood-resistant foundations is crucial. Wood should be preservative-treated for foundation or marine use (aboveground or ground-contact treatment will not be sufficient). Cuts and holes should be field-treated. Masonry should be reinforced and fully grouted (see Fact Sheet No. 4.2 for masonry details). Concrete should be reinforced and composed of a high-strength, low water-to-cement ratio mix.

**Lateral Support at the Top of the Wall** – Foundation walls must be designed and constructed to withstand all flood, wind, and seismic forces, as well as any unbalanced soil/hydrostatic loads. The walls will typically require lateral support from the floor system and diaphragm, and connections to the top of the walls must be detailed properly. Cripple walls, where used, should be firmly attached and braced.

**Flood Openings and Ventilation Openings** – Any area below the DFE enclosed by foundation walls must be equipped with openings capable of automatically equalizing the water levels inside and outside the enclosure. Specific flood opening requirements are included in Fact Sheet No. 8.1. Flood openings are not required for backfilled stemwall foundations supporting a slab. **Air ventilation openings required by building codes do not generally satisfy the flood opening requirement**; the air vents are typically installed near the top of the wall, the flood vents must be installed near the bottom, and opening areas for air flow may be insufficient for flood flow.

**Interior Grade Elevation** – Conventional practice for crawlspace construction calls for excavation of the



crawlspace and use of the excavated soil to promote drainage away from the structure (see left-hand figure on page 3). This approach may be acceptable for non-floodplain areas, but in floodplains, this practice can result in increased lateral loads (e.g., from saturated soil) against the foundation walls and ponding in the crawlspace area. If the interior grade of the crawlspace is below the DFE, NFIP requirements can be met by ensuring that the interior grade is at or above the lowest exterior grade adjacent to the building (see right-hand figure on page 3). When floodwaters recede, the flood openings in the foundation walls allow floodwaters to automatically exit the crawlspace. FEMA may accept a crawlspace elevation up to 2 feet below the lowest adjacent exterior grade; however, the community must adopt specific requirements in order for this type of crawlspace to be constructed in a floodplain.

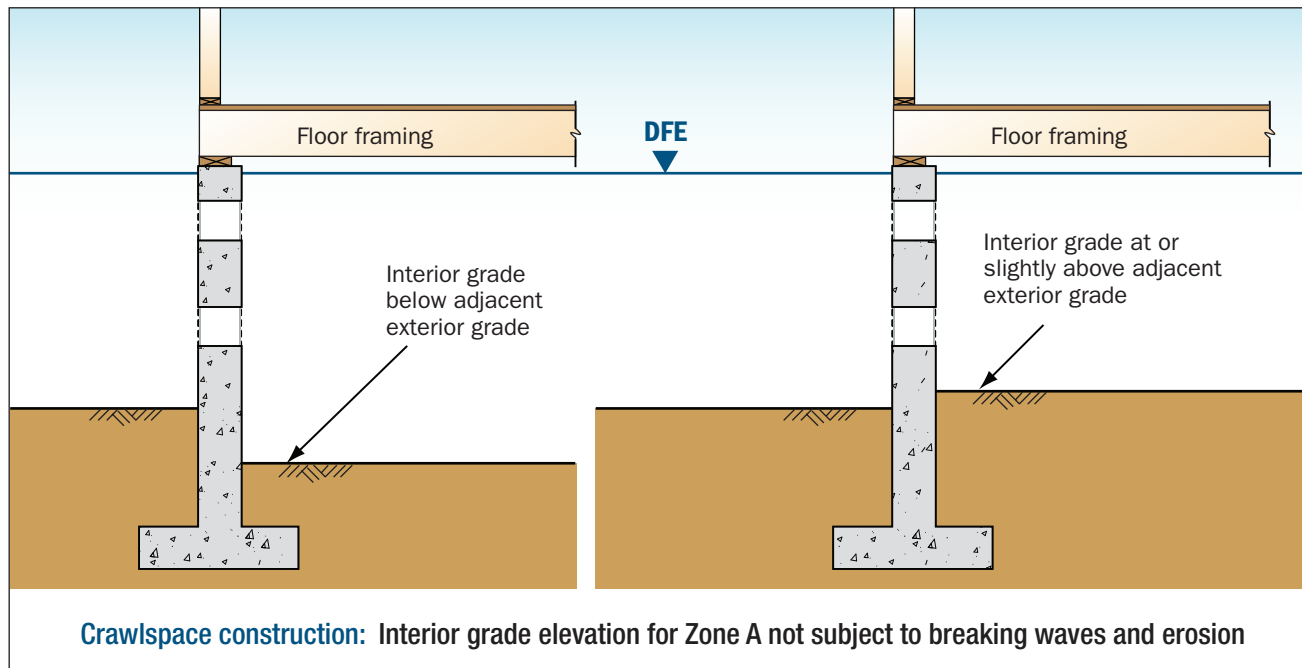
If a stemwall and floor slab system is used, the interior space beneath the slab should be backfilled with compacted gravel (or such materials as required by the building code). As long as the system can act monolithically, it will resist most flood forces. However, if the backfill settles or washes out, the slab will collapse and the wall will lose lateral support.

FEMA. NFIP Technical Bulletin 11-01, *Crawlspace Construction*. 2001. (<http://www.fema.gov/plan/prevent/floodplain/techbul.shtm>)

FEMA. *Recommended Residential Construction for the Gulf Coast, Building on Strong and Safe Foundations*. FEMA 550. 2010. (<http://www.fema.gov/library>)

### Additional Resources

FEMA. NFIP Technical Bulletin 1-08, *Openings in Foundation Walls and Walls of Enclosures*. 2008. (<http://www.fema.gov/plan/prevent/floodplain/techbul.shtm>)



Developed in association with the National Association of Home Builders Research Center



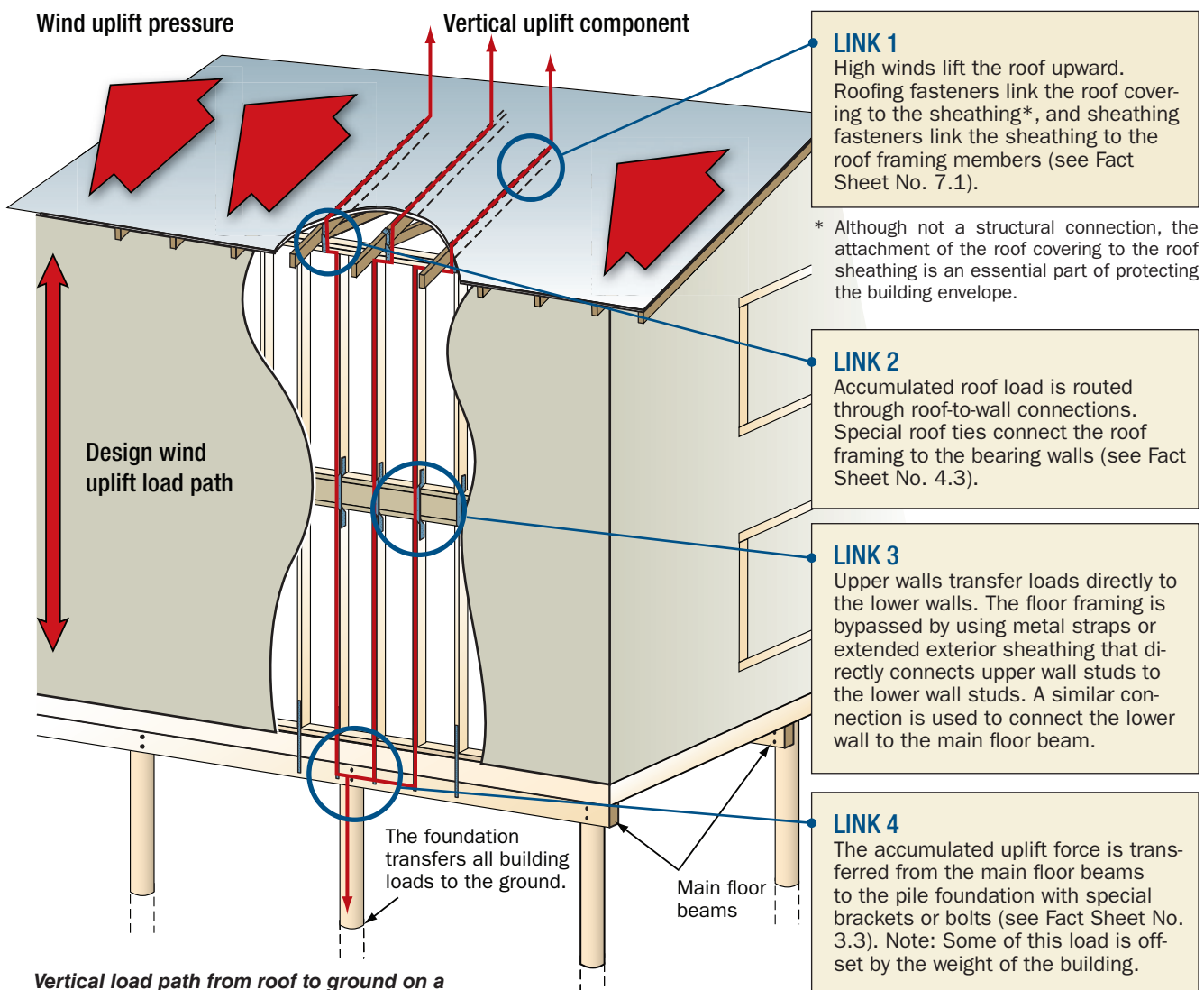


# Load Paths

**Purpose:** To illustrate the concept of load paths and highlight important connections in a wind uplift load path.

## Key Issues

- Loads acting on a building follow many paths through the building and must eventually be resisted by the ground, or the building will fail.
- Loads accumulate as they are routed through key connections in a building.
- Member connections are usually the weak link in a load path.
- Failed or missed connections cause loads to be rerouted through unintended load paths.

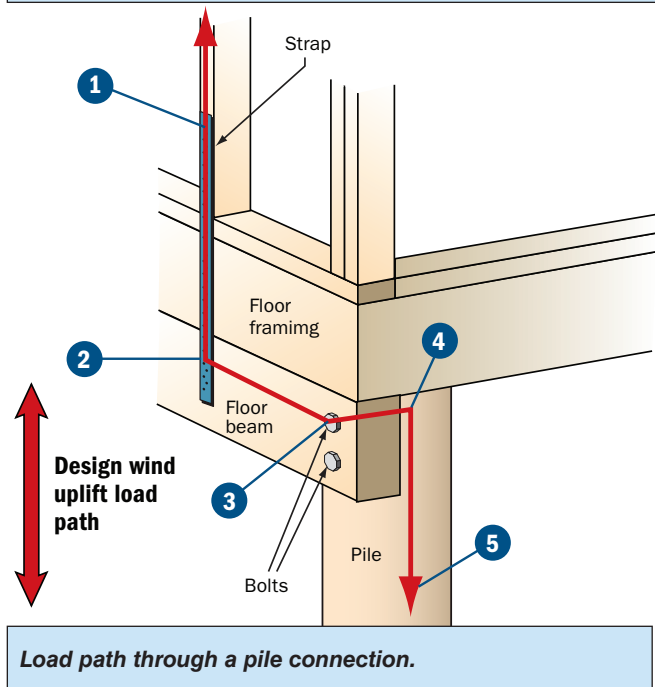
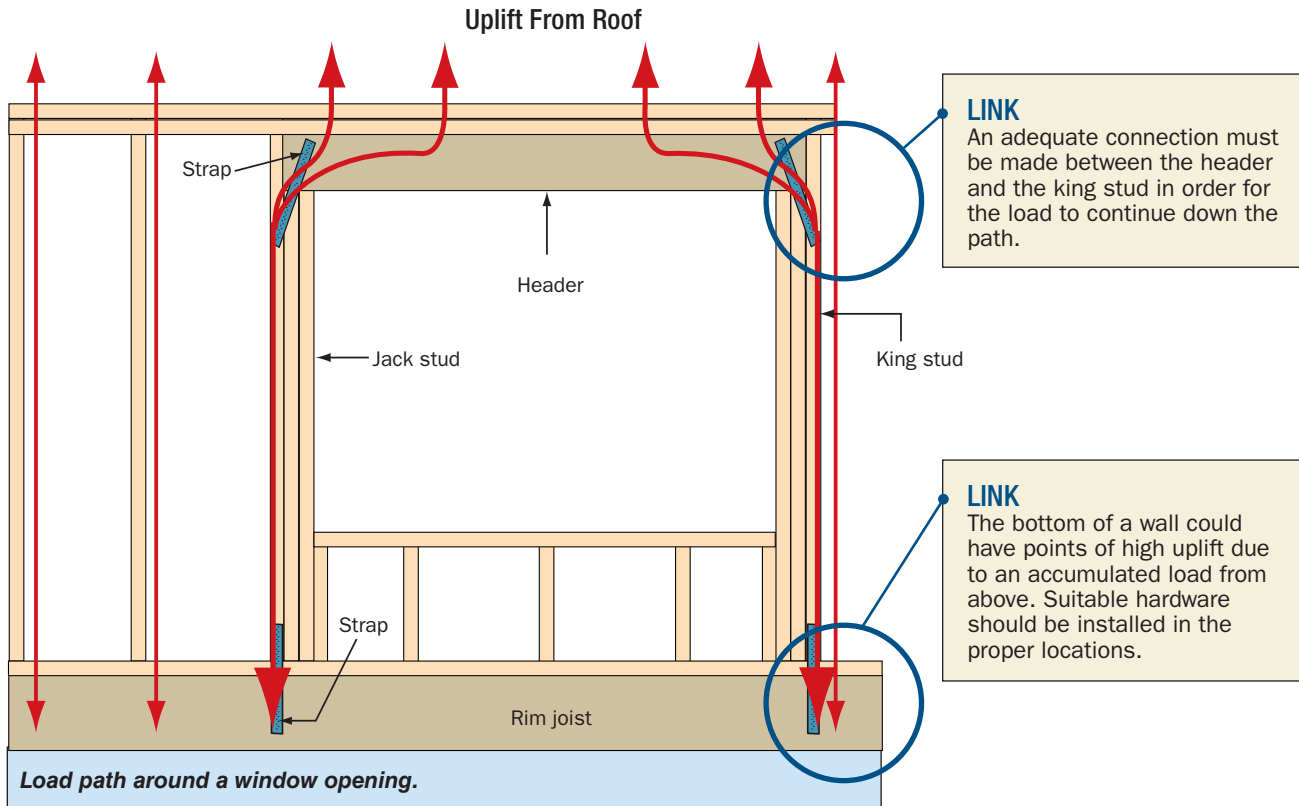


**Vertical load path from roof to ground on a platform-and-pile-construction building. Note: Load paths will vary depending on construction type and design. Adjacent framing members will receive more load if a connection fails.**

Note: Horizontal load paths transferring shear from upper stories to the ground must also be analyzed.



If a connection fails, an alternative load path will form. If the members and connections in the new load path have inadequate resistance, progressive failure can occur. Loads must be routed around openings, such as windows and doors. Accumulated loads on headers are transferred to the studs on the sides of the opening.



Load paths can be complex through a connection. It is important that each link within the connection be strong enough to transfer the full design load.

The detail at left shows a typical floor-to-pile connection. Uplift loads are transferred through the joint in the following order.

- 1 from upper story to strap
- 2 from strap to floor beam
- 3 from floor beam to bolts
- 4 from bolts to pile
- 5 from pile to ground



# Masonry Details

**Purpose:** To highlight several important details for masonry construction in coastal areas.

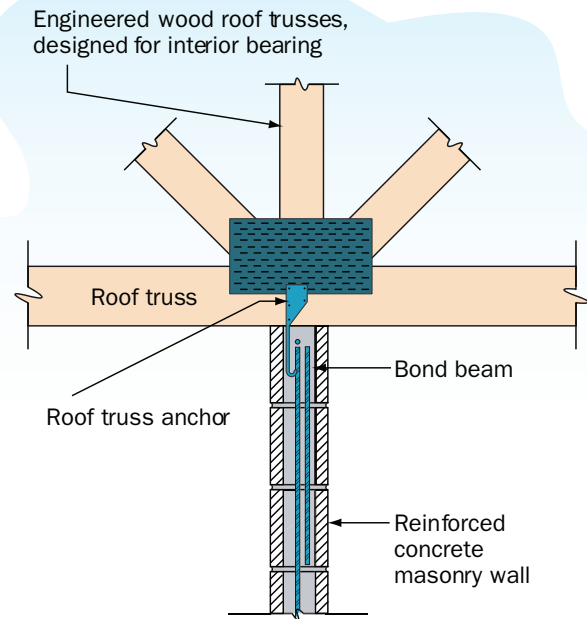
## Key Issues

- Continuous, properly connected load paths are essential because of the higher vertical and lateral loads on coastal structures.
- Building materials must be durable enough to withstand the coastal environment.
- Masonry reinforcement requirements are more stringent in coastal areas.

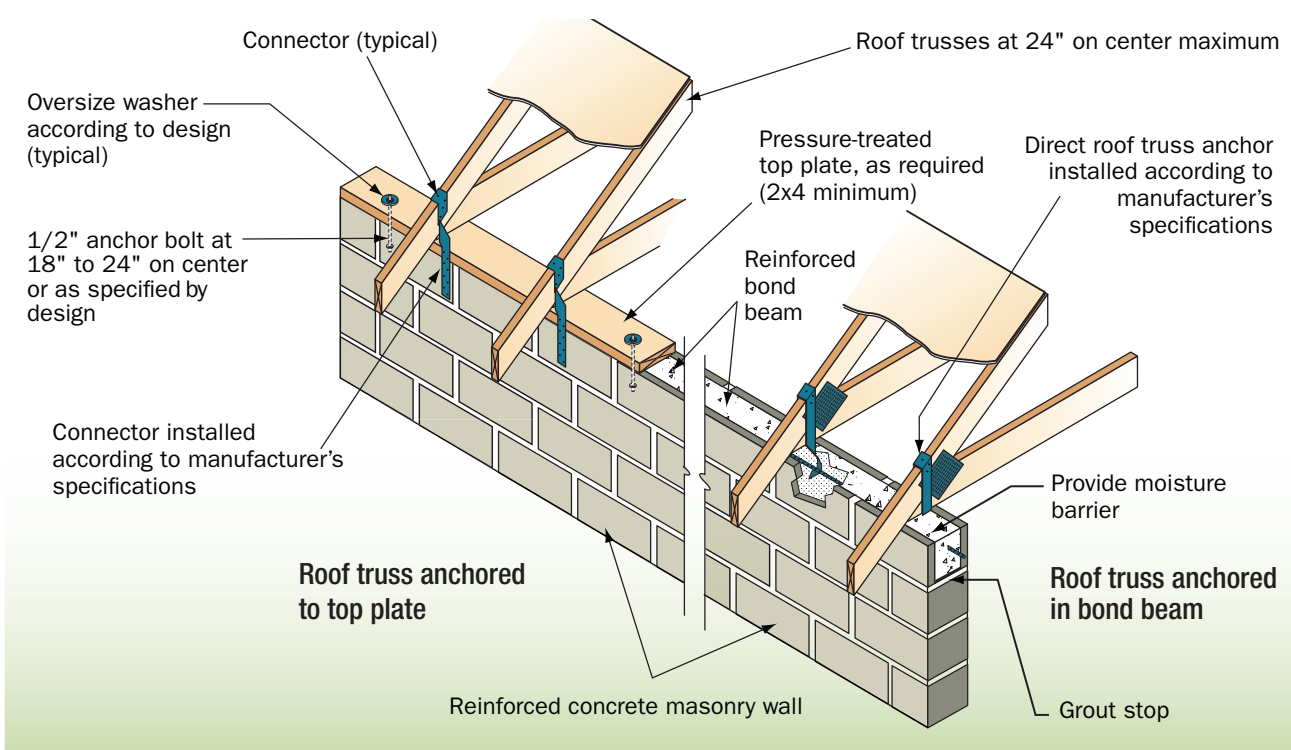
## Load Paths

A properly connected load path from roof to foundation is crucial in coastal areas (see Fact Sheets Nos. 4.1 and 4.3). The following details show important connections for a typical masonry home.

Roof framing to interior masonry wall



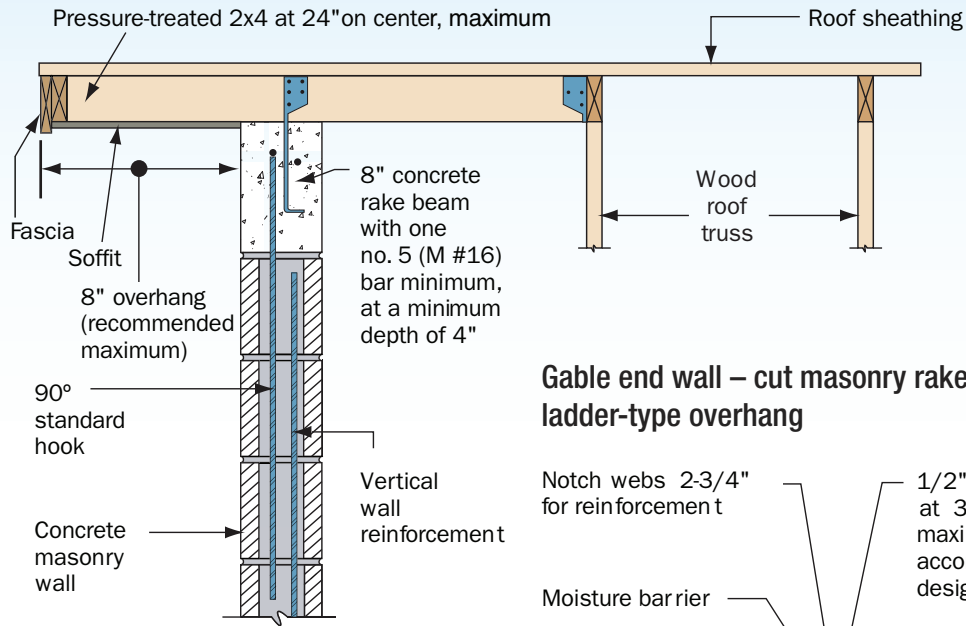
Roof framing to masonry wall



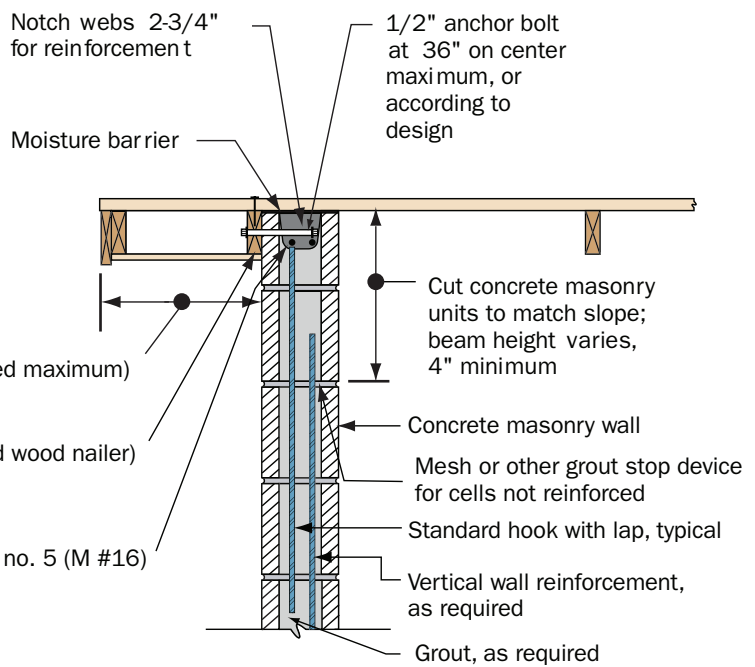
LOAD PATHS 4



## Gable end wall – cut concrete rake beam without looker-type overhang



## Gable end wall – cut masonry rake beam with ladder-type overhang

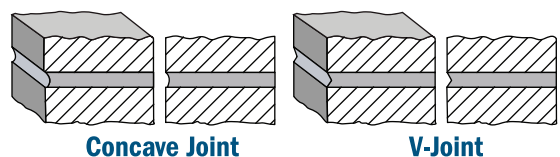


### Gable endwall connections.

**Durability** – High winds and salt-laden air can damage masonry construction. The entry of moisture into large cracks can lead to corrosion of the reinforcement and subsequent cracking and spalling. Moisture resistance is highly dependent on the materials and quality of construction.

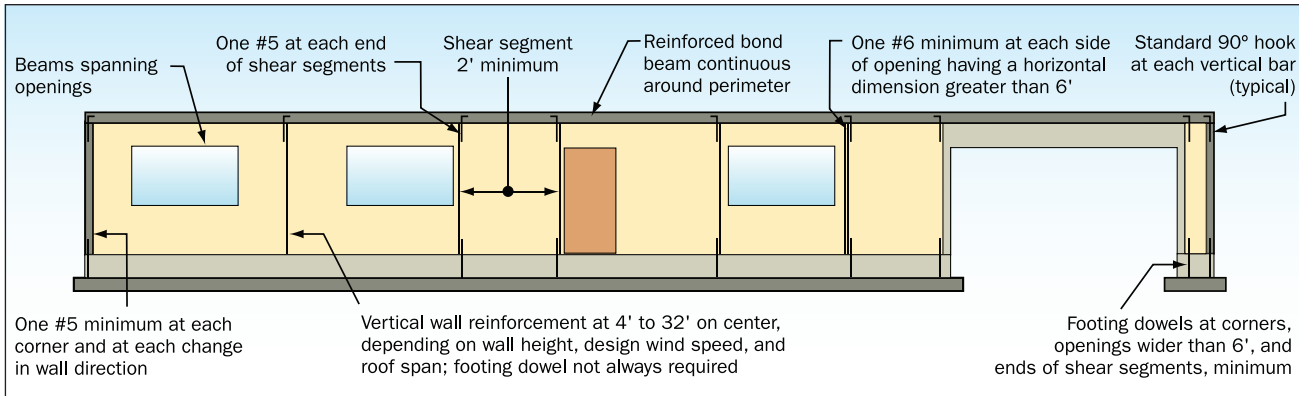
Quality depends on:

- **Proper storage of material** – Keep stored materials covered and off the ground.
- **Proper batching** – Mortar and grout must be properly batched to yield the required strength.
- **Good workmanship** – Head and bed joints must be well mortared and well tooled. Concave joints and V-joints provide the best moisture protection (see detail above). All block walls should be laid with full mortar coverage on horizontal and vertical face shells. Block should be laid using a “double butter” technique for spreading mortar head joints. This practice provides for mortar-to-mortar contact as two blocks are laid together in the wall and prevents hairline cracking in the head joint.



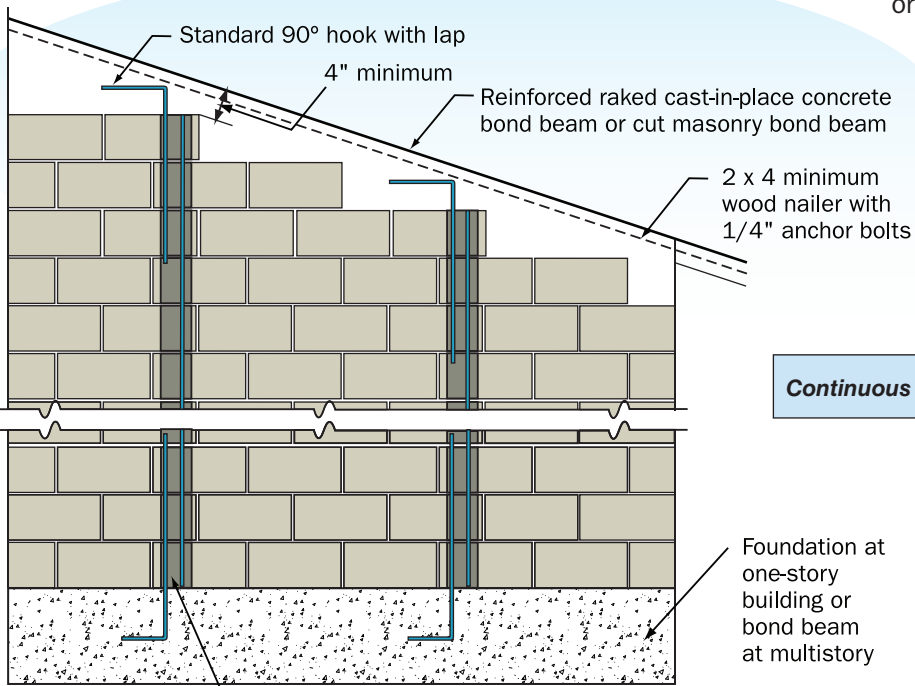
- **Protection of work in progress** – Keep work in progress protected from rain. During inclement weather, the tops of unfinished walls should be covered at the end of the workday. The cover should extend 2 feet down both sides of the masonry and be securely held in place. Immediately after the completion of the walls, the wall cap should be installed to prevent excessive amounts of water from directly entering the masonry.

**Reinforcement:** Masonry must be reinforced according to the building plans. Coastal homes will typically require more reinforcing than inland homes. The following figure shows typical reinforcement requirements for a coastal home.



**Masonry reinforcement.**

**Gable Ends:** Because of their exposure, gable ends are more prone to damage than are hipped roofs unless the joint in conventional construction at the top of the endwall and the bottom of the gable is laterally supported for both inward and outward forces. The figure at right shows a construction method that uses continuous masonry from the floor to the roof diaphragm with a raked cast-in-place concrete bond beam or a cut masonry bond beam.



**Continuous gable endwall reinforcement.**

Cleanouts required for grout pour heights greater than 5' unless footing dowel is not required

Developed in association with the National Association of Home Builders Research Center





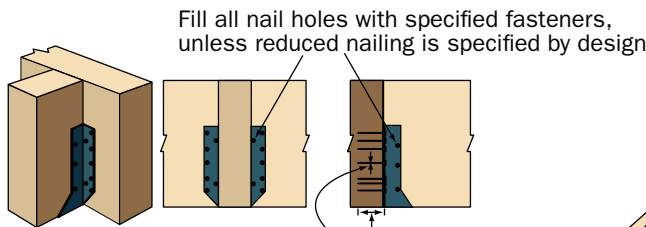
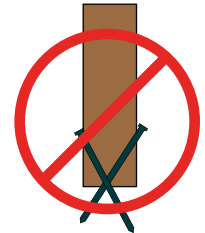
# Use of Connectors and Brackets

**Purpose:** To highlight important building connections and illustrate the proper use of various types of connection hardware.

## Key Issues

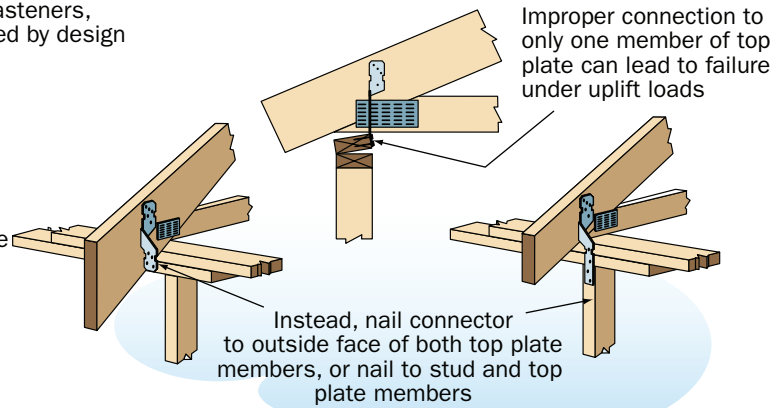
- In high-wind regions, special hardware is used for most framing connections. Toe-nailing is not an acceptable method for resisting uplift loads in high-wind regions.
- Hardware must be installed according to the manufacturer's or engineer's specifications.
- The correct number of the specified fasteners (length and diameter) must be used with connection hardware.
- Avoid cross-grain tension in connections.
- Metal hardware must be adequately protected from corrosion (see NFIP Technical Bulletin 8-96).
- Connections must provide a continuous load path (see Fact Sheet No. 4.1).

Never rely on toe-nailing for uplift connections in high-wind areas

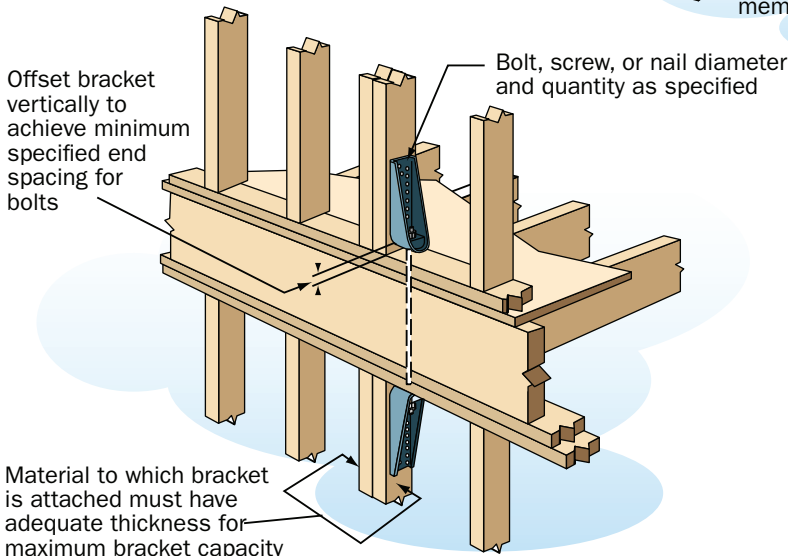


The length and diameter of the fasteners must be as specified by the manufacturer or engineer; some specifications require non-standard nails

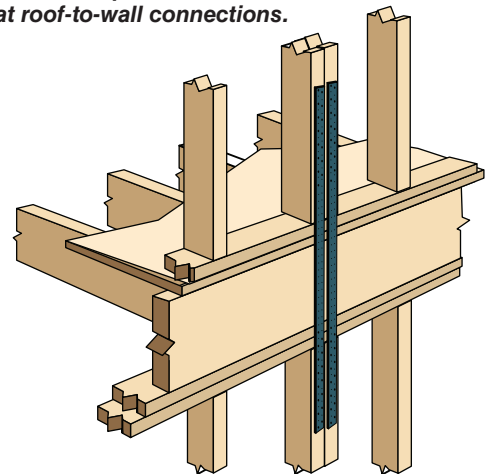
**Proper fasteners must be used with connection hardware.**



**Avoid load path failure at roof-to-wall connections.**



**Proper bracket connection.**

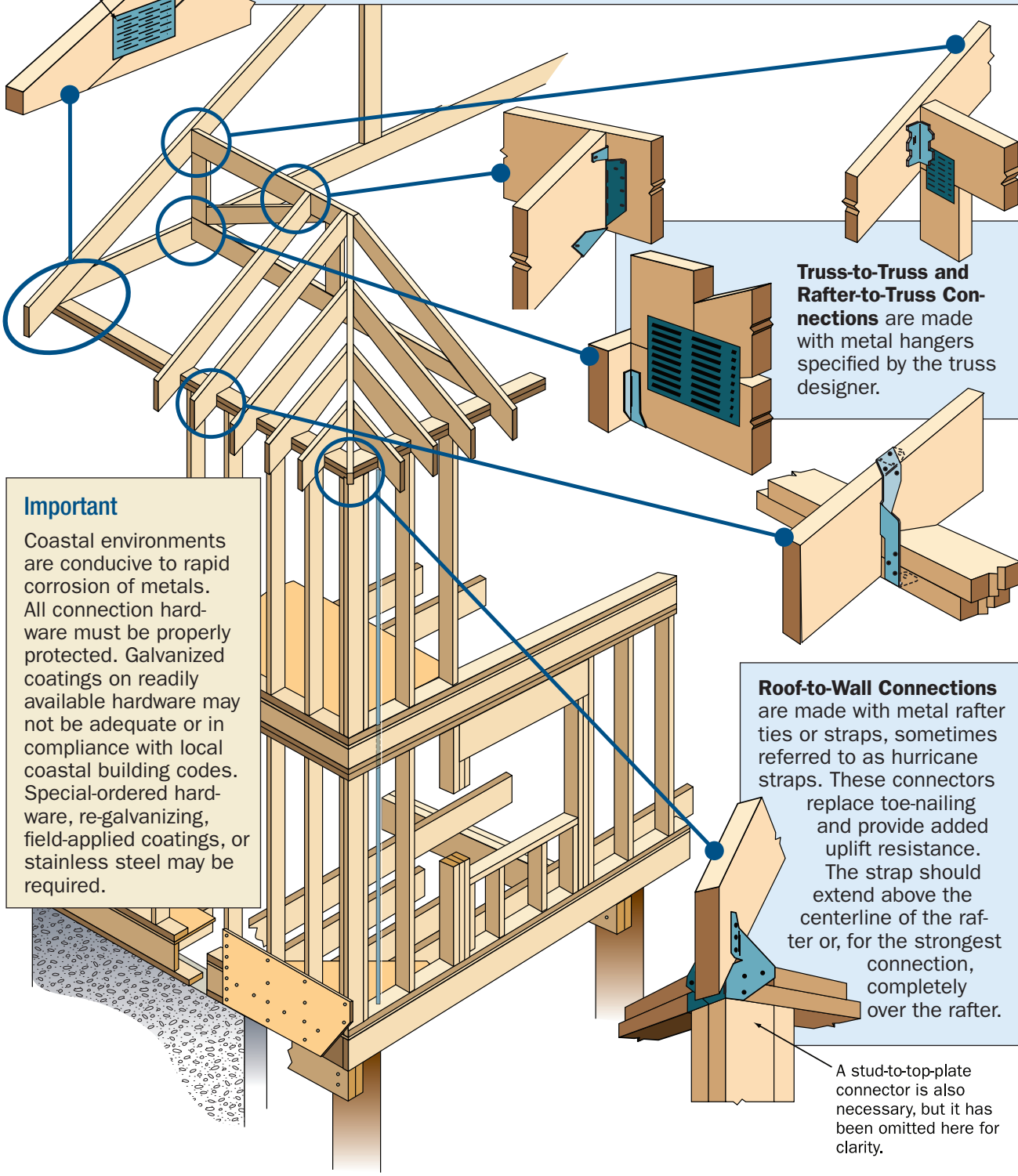


**Proper strap connection.**



**Truss Member Connections** are made with metal plates that connect the individual parts of a truss to form a structural component. Every joint must have a connector plate on each face sized and positioned according to engineered designs. Plates must be fully embedded, and gaps at joints should be minimized (see ANSI/TPI-1 95).

Truss plate



**Important**  
Coastal environments are conducive to rapid corrosion of metals. All connection hardware must be properly protected. Galvanized coatings on readily available hardware may not be adequate or in compliance with local coastal building codes. Special-ordered hardware, re-galvanizing, field-applied coatings, or stainless steel may be required.

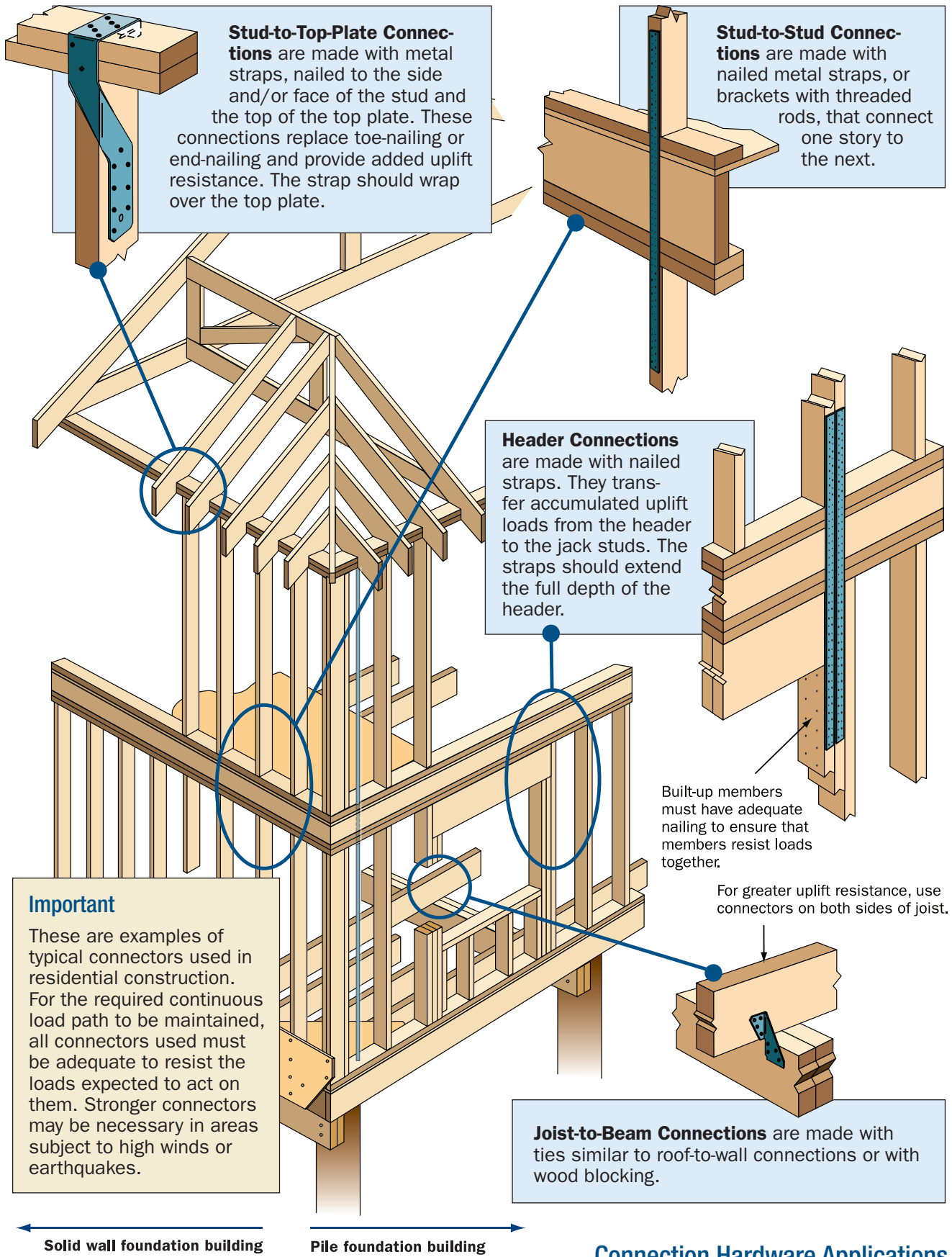
**Truss-to-Truss and Rafter-to-Truss Connections** are made with metal hangers specified by the truss designer.

**Roof-to-Wall Connections** are made with metal rafter ties or straps, sometimes referred to as hurricane straps. These connectors replace toe-nailing and provide added uplift resistance. The strap should extend above the centerline of the rafter or, for the strongest connection, completely over the rafter.

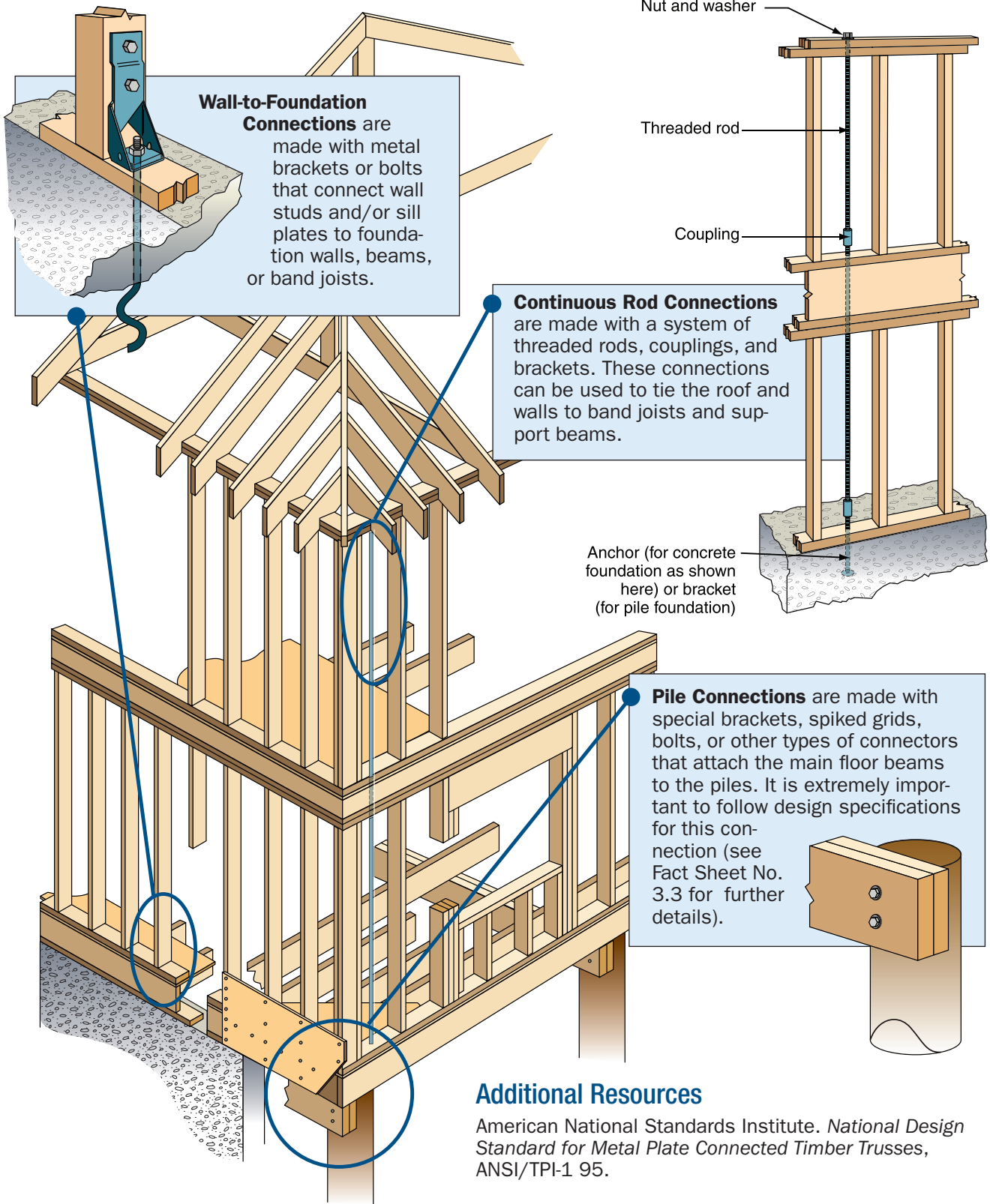
A stud-to-top-plate connector is also necessary, but it has been omitted here for clarity.

← Solid wall foundation building      Pile foundation building →

**Connection Hardware Applications**



Connection Hardware Applications



**Additional Resources**

American National Standards Institute. *National Design Standard for Metal Plate Connected Timber Trusses*, ANSI/TPI-1 95.

**Connection Hardware Applications**



Developed in association with the National Association of Home Builders Research Center





# Housewrap

**Purpose:** *To explain the function of housewrap, examine its attributes, and address common problems associated with its use.*

## Key Issues

- Housewrap has two functions: to prevent airflow through a wall and to stop (and drain) liquid water that has penetrated through the exterior finish.
- Housewrap is not a vapor retarder. It is designed to allow water vapor to pass through.
- The choice to use housewrap or building paper depends on the climate and on specifier or owner preference. Both materials can provide adequate protection.
- Housewrap **must** be installed properly or it could be more detrimental than beneficial.

Proper installation, especially in lapping, is the key to successful housewrap use.



## Purpose of Housewrap

Housewrap serves as a dual-purpose weather barrier. It not only minimizes the flow of air in and out of a house, but also stops liquid water and acts as a drainage plane. Housewrap is not a vapor retarder. The unique characteristic of housewrap is that it allows water vapor to pass through it while blocking liquid water. This permits moist humid air to escape from the inside of the home, while preventing outside liquid water (rain) from entering the home.

## When Should Housewrap Be Used?

Almost all exterior finishes allow at least some water penetration. If this water continually soaks the wall sheathing and framing members, problems such as dryrot and mold growth could occur. Housewrap stops water that passes through the siding and allows it to drain away from the structural members. In humid climates with heavy rainfall, housewrap is recommended to prevent water damage to the framing. Use in dryer climates may not be as critical, since materials are allowed to adequately dry, although

housewrap also prevents air movement through the wall cavity, which is beneficial for insulating purposes.

## Housewrap or Building Paper?

To answer this question, it is important to know what attributes are most important for a particular climate. Five attributes associated with secondary weather barriers are:

- **Air permeability** – ability to allow air to pass through
- **Vapor permeability** – ability to allow water vapor (gaseous water) to pass through
- **Water resistance** – ability to prevent liquid water from passing through
- **Repels moisture** – ability to prevent moisture absorption
- **Durability** – resistance to tearing and deterioration



As shown in the following table, the climate where the house is located determines the importance of the attribute.

Product Attribute Rating		Poor – Fair – Good – Excellent	
Attribute	When it is Important	Product Performance	
		Building Paper	Housewrap
Air Permeability	Windy and cold climates	Fair	Good
Vapor Permeability	Hot, humid climates	Fair	Good
Water Resistance	Windy and rainy climates	Good	Excellent
Repels Moisture	High rainfall	Good	Good
Durability	Windy, with possible extended exposure	Fair	Good
Cost	Owner preference	Excellent	Fair

*In general, housewrap is a good choice for coastal homes.*

## Installing Housewrap

No matter what product is used (housewrap or building paper), neither will work effectively if not installed correctly. In fact, installing housewrap incorrectly could do more harm than not using it at all. Housewrap is often thought of and installed as if it were an air retarder alone. A housewrap will channel water and collect it whether the installer intends it to or not. This can lead to serious water damage if the housewrap is installed in a manner that does not allow the channeled water out of the wall system. The following are tips for successful installation of housewrap:

- Follow manufacturers' instructions.
- Plan the job so that housewrap is applied before windows and doors are installed.
- Proper lapping is the key – the upper layer should always be lapped over the lower layer.
- Weatherboard-lap horizontal joints at least 6 inches.
- Lap vertical joints 6 to 12 inches (depending on potential wind-driven rain conditions).
- Use 1-inch minimum staples or roofing nails spaced 12 to 18 inches on center throughout.
- Tape joints with housewrap tape.
- Allow drainage at the bottom of the siding.
- Extend housewrap over the sill plate and foundation joint.
- Install housewrap such that water will never be allowed to flow to the inside of the wrap.

- Avoid complicated details in the design stage to prevent water intrusion problems.
- When sealant is required:
  - use backing rods as needed,
  - use sealant that is compatible with the climate,
  - use sealant that is compatible with the materials it is being applied to,
  - surfaces should be clean (free of dirt and loose material), and
  - discuss maintenance with the homeowner.

## Avoid These Common Problems

### ■ Incomplete wrapping

Gable ends are often left unwrapped, leaving a seam at the low end of the gable. This method works to prevent air intrusion, but water that gets past the siding will run down the unwrapped gable end and get behind the housewrap at the seam. Also, it is common for builders to pre-wrap a wall before standing it. If this is done, the band joist is left unwrapped. Wrap the band joist by inserting a strip 6 to 12 inches underneath the bottom edge of the wall wrap. In addition, outside corners are often missed.

### ■ Improper lapping

This often occurs because the housewrap is thought of as an air retarder alone. When applying the housewrap, keep in mind that it will be used as a vertical drainage plane, just like the siding.

- Improper integration with flashing around doors and windows – See Fact Sheet No. 6.1.
- Relying on caulking or self-sticking tape to address improper lapping

Sealant can and will deteriorate over time. A lapping mistake corrected with sealant will have a limited time of effectiveness. If the homeowner does not perform the required maintenance, serious water damage could occur when the sealant eventually fails. ***Therefore, do not rely on sealant or tape to correct lapping errors.***



Developed in association with the National Association of Home Builders Research Center





# Roof-to-Wall and Deck-to-Wall Flashing

**Purpose:** To emphasize the importance of proper roof and deck flashing, and to provide typical and enhanced flashing techniques for coastal homes.

## Key Issues

- Poor performance of flashing and subsequent water intrusion is a **common problem** for coastal homes.
- **Enhanced flashing techniques are recommended** in areas that frequently experience high winds and driving rain.
- **Water penetration** at deck ledgers can cause **wood dry rot and corrosion of connectors** leading to **deck collapse**.

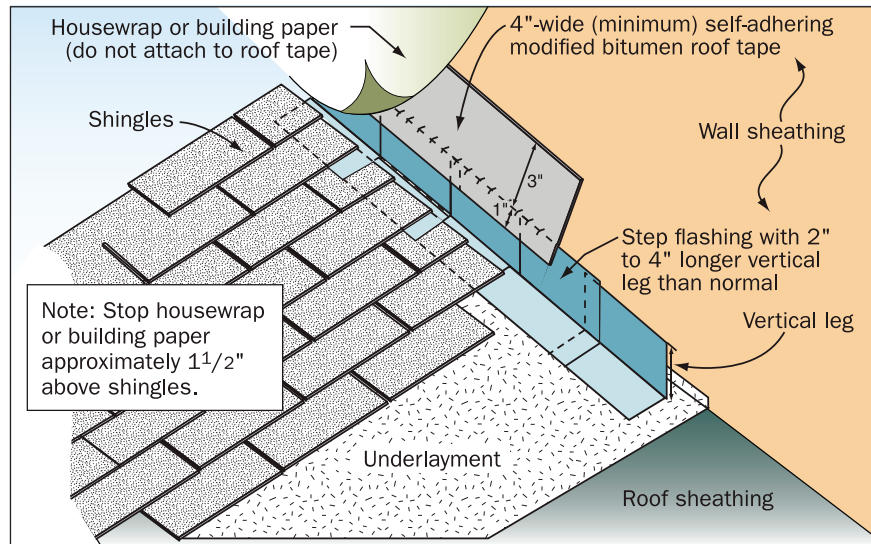


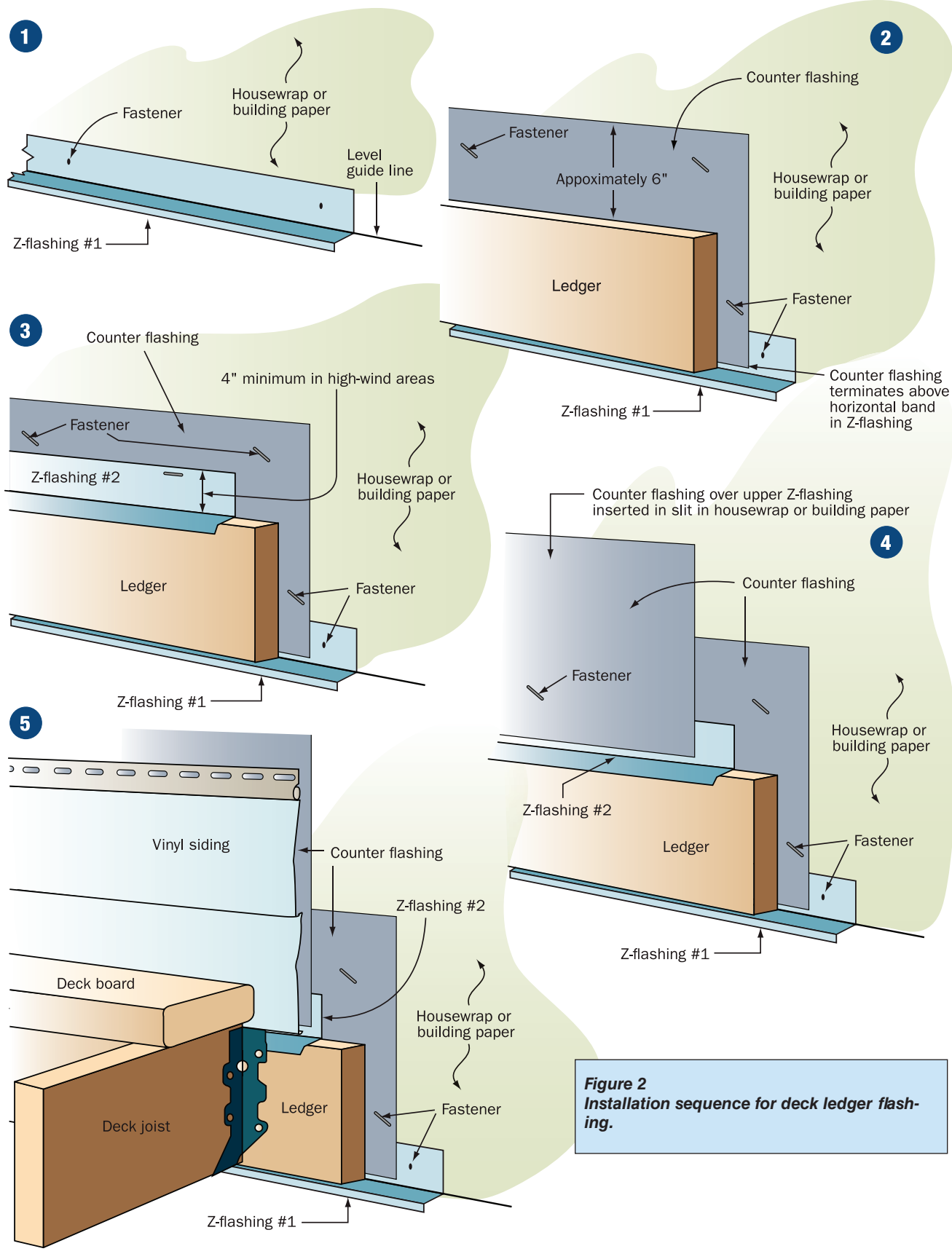
Figure 1. Roof/wall flashing detail.

## Roof and Deck Flashing Recommendations for Coastal Areas

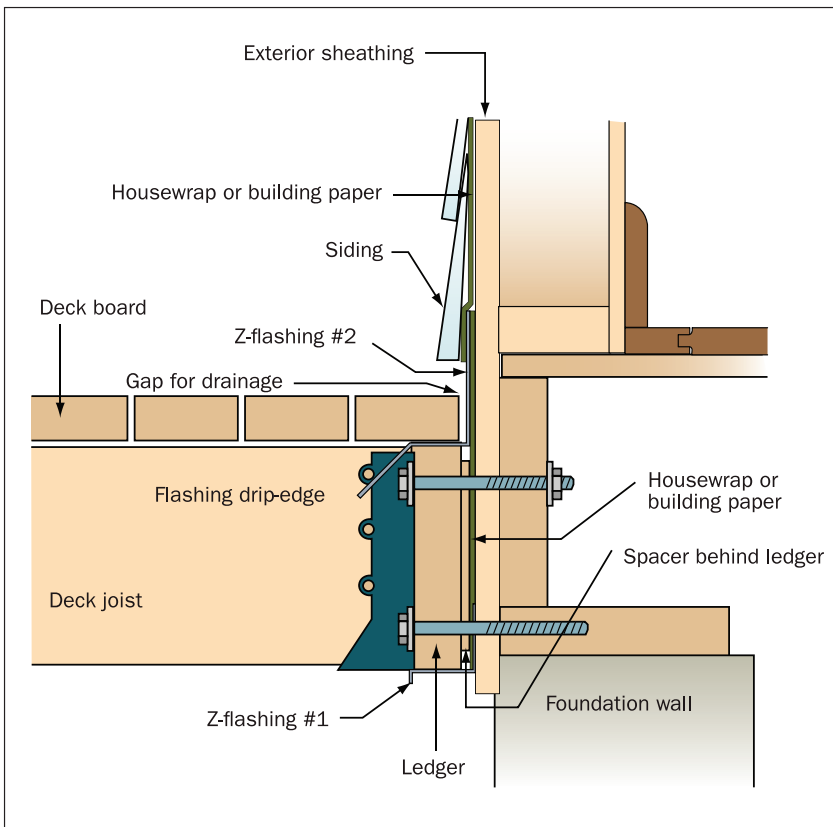
- **Always** lap flashing and other moisture barriers properly.
- Use increased lap lengths for added protection.
- Do not rely on sealant as a substitute for proper lapping.
- Use fasteners that are compatible with or of the same type of metal as the flashing material.
- Use flashing cement at joints to help secure flashing.
- At roof-to-wall intersections (see Figure 1):
  - Use step flashing that has a 2- to 4-inch-longer vertical leg than normal.
  - Tape the top of step flashing with 4-inch-wide (minimum) self-adhering modified bitumen roof tape.
  - Do not seal housewrap or building paper to step flashing.
- For deck flashing:
  - Follow proper installation sequence to prevent water penetration at deck ledger (see Figure 2).
  - Leave gap between first deck board and flashing to allow for drainage (see Figure 3).
  - Use spacer behind ledger to provide gap for drainage (see Figure 3).
  - Use stainless steel deck connection hardware.

See Fact Sheet Nos. 7.2 and 7.3 for rake and eave details.





**Figure 2**  
Installation sequence for deck ledger flashing.



**Figure 3 Deck ledger flashing.**

*Developed in association with the National Association of Home Builders Research Center*







# Siding Installation in High-Wind Regions

**Purpose:** *To provide basic design and installation tips for various types of siding that will enhance wind resistance in high-wind regions (i.e., greater than 90 miles per hour [mph] basic [gust design] wind speed)<sup>1</sup>.*

## Key Issues

- Siding is frequently blown off walls of residential and non-residential buildings during hurricanes. Also, wind-driven rain is frequently blown into wall cavities (even when the siding itself is not blown off). Guidance for achieving successful wind performance is presented in the following.
- To avoid wind-driven rain penetration into wall cavities, an effective moisture barrier (housewrap or building paper) is needed. For further information on moisture barriers, see Fact Sheet No. 1.9, Moisture Barrier Systems. For further information on housewrap, see Fact Sheet No. 5.1, Housewrap.
- Always follow manufacturer's installation instructions and local building code requirements.
- Use products that are suitable for a coastal environment. Many manufacturers do not rate their products in a way that makes it easy to determine whether the product will be adequate for the coastal environment. Use only siding products where the supplier can provide specific information on product performance in coastal or high-wind environments.
- For buildings located within 3,000 feet of the ocean line, stainless steel fasteners are recommended.
- Avoid using dissimilar metals together.
- The installation details for starting the first (lowest) course of lap siding can be critical. Loss of siding often begins at the lowest course and proceeds up the wall (Figures 4 and 12). This is particularly important for elevated buildings, where the wind blows under the building as well as against the sides.
- When applying new siding over existing siding, use shims or install a solid backing to create a uniform, flat surface on which to apply the siding, and avoid creating gaps or projections that could catch the wind.
- Coastal buildings require more maintenance than inland buildings. This maintenance requirement needs to be considered in both the selection and installation of siding.

**Moisture barrier** (also known as a water-resistive barrier): In the context of residential walls, the moisture barrier is either housewrap or building paper (felt). The moisture barrier occurs between the wall sheathing and the siding. It is a dual-purpose layer that sheds water that gets through the siding and limits air flow through the wall. When properly sealed, housewrap is considered an air barrier. Although building paper provides some resistance to air flow, it is not considered an air barrier. Moisture barriers shed water, but they allow water vapor to pass through them.

For further guidance on principles, materials, and procedures for the design and construction of walls to make them resistant to water intrusion, see American Society for Testing and Materials (ASTM) E 2266, *Standard Guide for Design and Construction of Low-Rise Frame Building Wall Systems to Resist Water Intrusion*.

<sup>1</sup> The 90 mph speed is based on ASCE 7-05. If ASCE 7-10 is being used, the equivalent wind speed is 116 mph for Risk Category II buildings.



## Vinyl Siding

Vinyl siding can be used successfully in a coastal environment if properly designed and installed.

### Windload Resistance

Vinyl siding is required by the International Building Code (IBC) and the International Residential Code (IRC) to comply with ASTM D 3679, *Standard Specification for Rigid Poly (Vinyl Chloride) (PVC) Siding*. Both the IBC and IRC require static pressure testing over solid wall surfaces capable of independently resisting the design wind pressures to approximate loading conditions that occur in 110-mph wind zone areas for a building up to 30 feet in height in Exposure B.<sup>2</sup> Most vinyl siding has also been tested for higher wind pressures and can be used in locations with a higher basic wind speed, greater building height, more open exposure, or some combination of these. While vinyl siding wind pressure ratings found in most product literature are based on tests of the vinyl over an approved sheathing capable of independently resisting the design wind pressures, methods of installation that rely on a combination of wind resistance provided by exterior wall sheathing, vinyl siding, and interior wall sheathing are available for some applications. The design wind pressure or wind speed for which these products are rated, as well as requirements for sheathing behind the vinyl siding are available from product literature, installation instructions, or listings of agencies such as the International Code Council (ICC) Evaluation Service.

- For design wind speeds greater than 110 mph per ASCE 7-05, or 139 mph per ASCE 7-10, or building heights greater than 30 feet, or Exposure C, choose a siding product rated for those conditions or higher. The manufacturer's product literature or installation instructions should specify the fastener type, size and spacing, and any other installation details such as requirements for the sheathing materials behind the vinyl siding needed to achieve this rating.
- Products that have been rated for high winds typically have an enhanced nailing hem and are sometimes made from thicker vinyl (Figure 1). Thick, rigid panels provide greater wind resistance, withstand dents, and lie flatter and straighter against the wall. Optimum panel thickness should

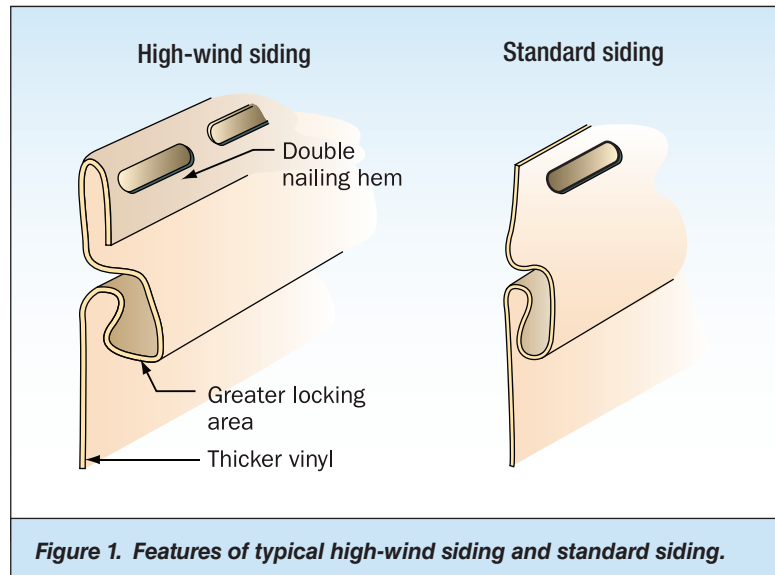


Figure 1. Features of typical high-wind siding and standard siding.

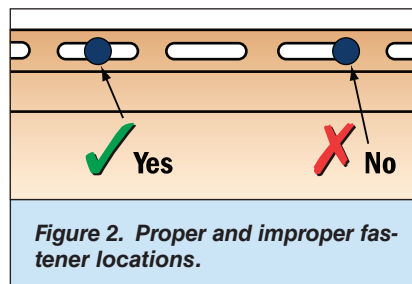


Figure 2. Proper and improper fastener locations.

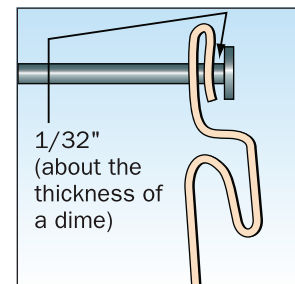


Figure 3. Allow 1/32" clearance between the fastener head and the siding panel.

be 0.040 to 0.048 inches, depending on style and design. Thinner gauge vinyl works well for stable climates; thicker gauge vinyl is recommended for areas with high winds and high temperature changes.

- Position nails in the center of the nailing slot (Figure 2). To allow for thermal movement of the siding, do not drive the head of the nail tight against the nail hem (unless the hem has been specifically designed for this). Allow approximately 1/32 inch (which is about the thickness of a dime) clearance between the fastener head and the siding panel (Figure 3).
- Drive nails straight and level to prevent distortion and buckling in the panel.
- Do not caulk the panels where they meet the receiver of inside corners, outside corners, or J-trim. Do not caulk the overlap joints.
- Do not face-nail or staple through the siding.

<sup>2</sup> The 110 mph wind speed is based on ASCE 7-05. If ASCE 7-10 is used, the equivalent wind speed is 139 mph for Risk Category II buildings.

- Use aluminum, galvanized steel, or other corrosion-resistant nails when installing vinyl siding. Aluminum trim pieces require aluminum or stainless steel fasteners.
- Nail heads should be 5/16 inch minimum in diameter. Shank should be 1/8 inch in diameter.
- Use the manufacturer-specified starter strip to lock in the first course; do not substitute other accessories such as a J-channel or utility trim (Figure 4) unless specified by the manufacturer. If the manufacturer specifies a particular strip for high-wind applications, use it. Make sure that the starter strip is designed to positively lock the panel, rather than just hooking over a bulge in the strip; field test the interlock before proceeding with the installation. Make sure that every course of siding is positively locked into the previous course (Figure 5). Push the panel up into the lock from the bottom before nailing rather than pulling from the top. Do not attempt to align siding courses with adjacent walls by installing some courses loosely.
- Make sure that adjacent panels overlap properly, about half the length of the notch at the end of the panel, or approximately 1 inch. Make sure the overlap is not cupped or gapped, which is caused by pulling up or pushing down on the siding while nailing. Reinstall any panels that have this problem.
- Use utility trim under windows or anywhere the top nail hem needs to be cut from siding to fit around an obstacle. Be sure to punch snap-locks into the siding to lock into the utility trim. Do not overlap siding panels directly beneath a window (Figure 6).
- At gable end walls, it is recommended that vinyl siding be installed over approved sheathing capable of independently resisting the full design wind pressures rather than over plastic foam sheathing or combinations of exterior foam sheathing and interior gable end sheathing except as provided for in the IRC Section R703.11.2. Figure 7 depicts the vulnerability of siding on gable end walls not properly sheathed with approved materials capable of independently resisting the full design wind pressures.
- Install vinyl siding in accordance with manufacturer's installation instructions and local building code requirements. Ensure product rating is appropriate for the intended application.
- It is recommended that vinyl siding installers be certified under the VSI Certified Installer Program sponsored by the Vinyl Siding Institute.



**Figure 4.** Utility trim was substituted for the starter strip and the bottom lock was cut off the siding. Siding was able to pull loose under wind pressure.



**Figure 5.** The siding panel was not properly locked into the panel below.



**Figure 6.** Proper detailing around windows and other obstacles is important. Use utility trim, punch snap-locks into siding, and do not overlap directly beneath a window.

## Wood Siding

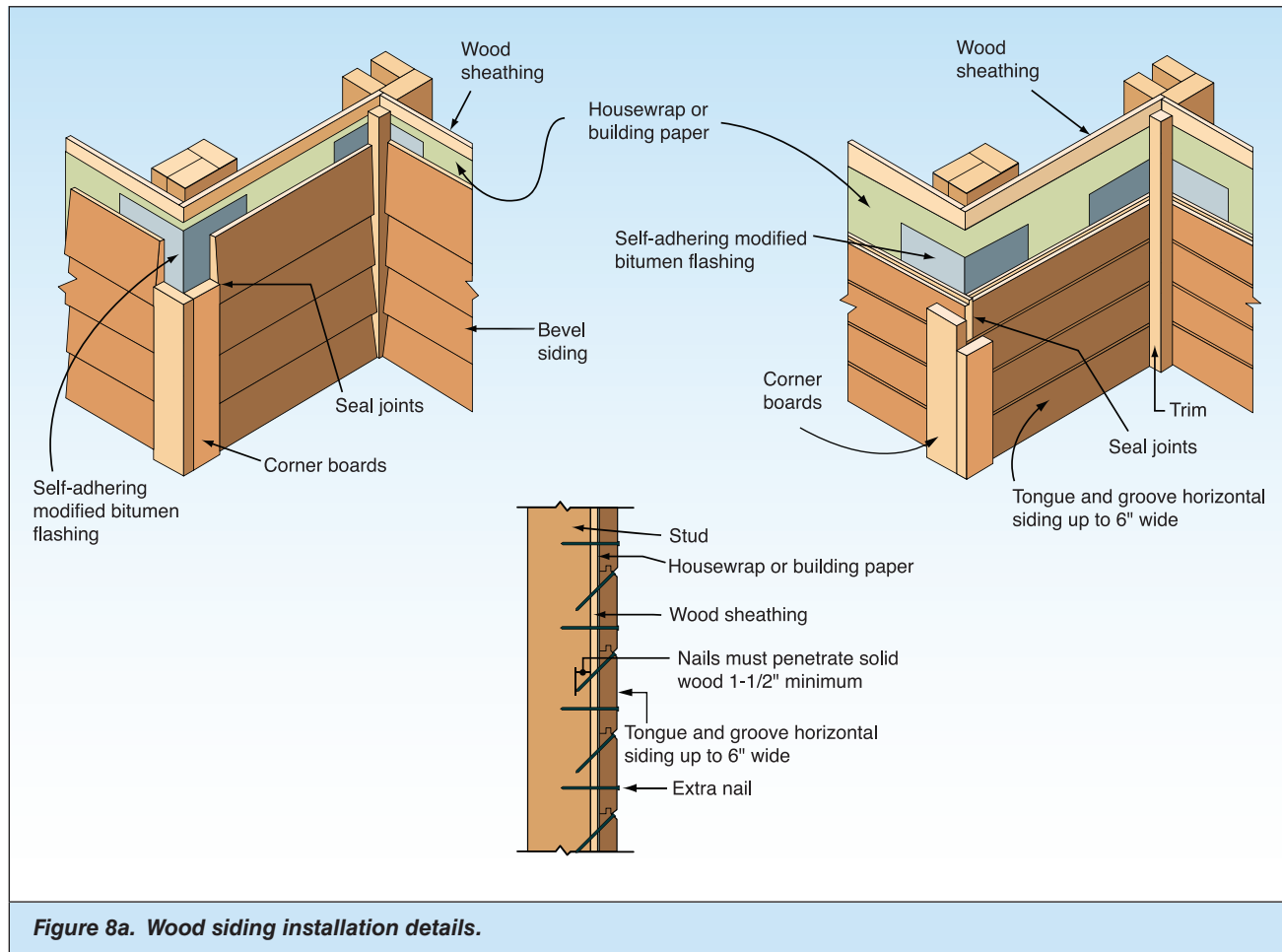
- Use decay-resistant wood such as redwood, cedar, or cypress. See the Sustainable Design section regarding certified wood.
- To improve longevity of paint, back-prime wood siding before installation.
- Carefully follow manufacturer's detailing instructions to prevent excessive water intrusion behind the siding.
- For attachment recommendations, see *Natural Wood Siding: Selection, Installation and Finishing*, published by the Western Wood Products Association.

This publication recommends an air gap between the moisture barrier and the backside of the siding to promote drainage and ventilation. Such a wall configuration is referred to as a rain screen wall. See the text box on page 5.

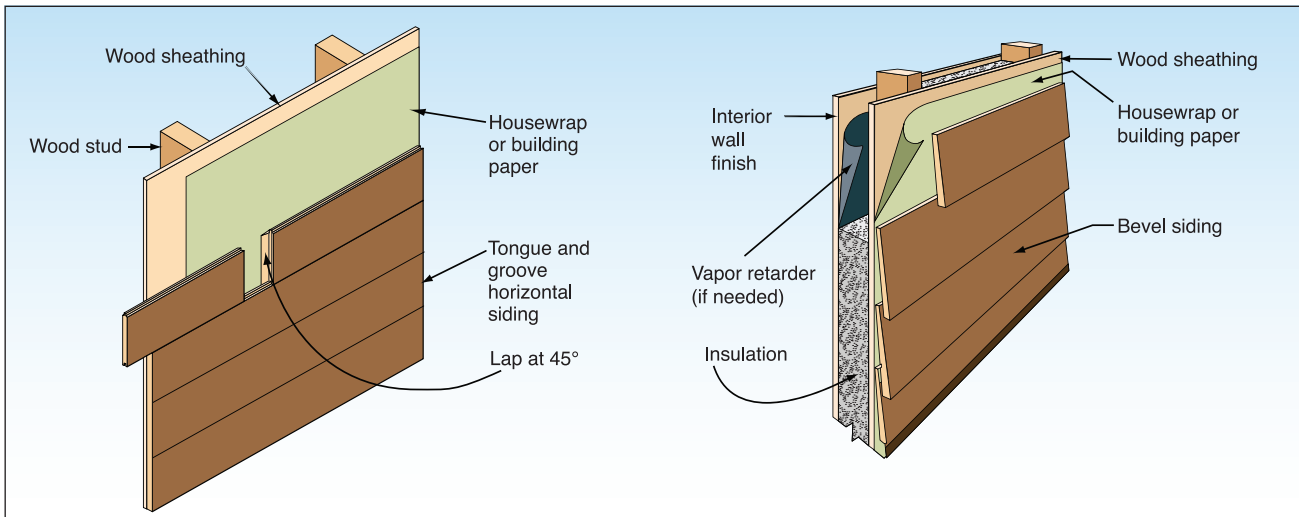
- Follow the installation details shown in Figures 8a and 8b. (Note: Although these details do not show a rain screen, inclusion of vertical furring strips to create a rain screen is recommended.)



**Figure 7.** The vinyl siding at this gable was installed over plastic foam insulation. Without wood sheathing, the wind pressures on the vinyl are increased. Also, if the siding blows away, the foam insulation is very vulnerable to blow-off. With loss of the foam insulation, wind-driven rain can freely enter the attic, saturate the ceiling insulation, and cause collapse of the ceiling.



**Figure 8a.** Wood siding installation details.



**Figure 8b. Wood siding installation details.**

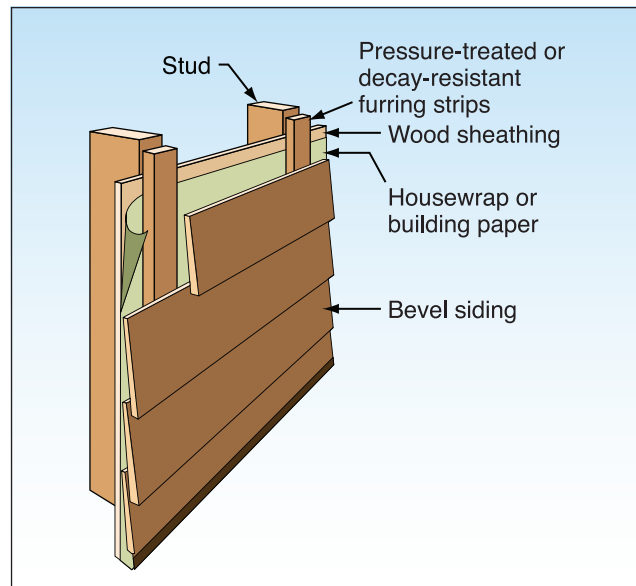
### Pressure-equalized rain screen wall system

In areas that experience frequent wind-driven rain and areas susceptible to high winds, it is recommended that a rain screen design be considered when specifying wood or fiber cement siding. (Typical vinyl siding products inherently provide air cavities behind the siding that facilitate drainage. Therefore, incorporation of vertical furring strips is normally not applicable to this type of wall covering.) A rain screen design is accomplished by installing suitable vertical furring strips between the moisture barrier and siding material (see Figure 9). The cavity facilitates drainage of water from the space between the moisture barrier and backside of the siding and it facilitates drying of the siding and moisture barrier.

**Furring strip attachment:** For 1 by 2 inches furring strips, tack strips in place and use siding nails that are 3/4 inch longer than would be required if there were no strips (to maintain the minimally required siding nail penetration into the studs). For thicker furring strips, an engineered attachment is recommended.

At the bottom of the wall, the cavity should be open to allow water drainage. However, the opening should be screened to avoid insect entry.

At the wall/soffit juncture, the top of the cavity can open into the attic space to provide inlet air ventilation, thereby, eliminating soffit vents and their susceptibility to wind-driven rain entry. If the rain screen cavity vent path is used instead of soffit vents, the depth of the cavity needs to be engineered to ensure that it provides sufficient air flow to ventilate the attic.



**Figure 9. Pressure-equalized rain screen system.**

### Fiber Cement Siding

- Installation procedures are similar to those for wood siding, but require specialized cutting blades and safety precautions because of the dust produced during cutting with power tools. Manufacturer's installation recommendations should be strictly adhered to, and particular attention paid to the painting and finishing recommendations for a high-quality installation.
- Always seal field-cut ends according to the manufacturer's instructions. Properly gap the intersection between siding edges and other building components and fill the gap with sealant.

- Always consult and follow the manufacturer's installation requirements for the needed wind speed rating or design pressure (refer to the manufacturer's building code compliance evaluation report). Observe the manufacturer's fastener specifications, including fastener type and size, spacing, and penetration requirements. Do not over drive or under drive.
- At gable end walls, it is recommended that fiber cement siding be installed over wood sheathing rather than over plastic foam sheathing.
- Keep blind nails between 3/4 and 1-inch from the top edge of the panel (Figure 10). Be sure to drive nails at least 3/8 inch from butt ends, or use manufacturer-specified joiners.

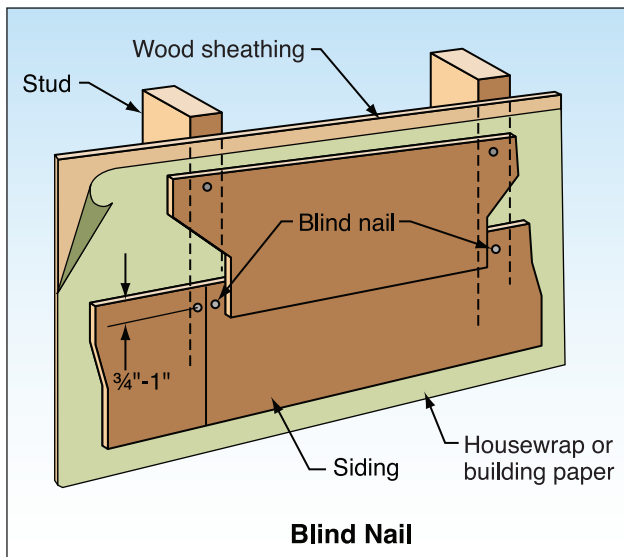


Figure 10. Blind nailing.

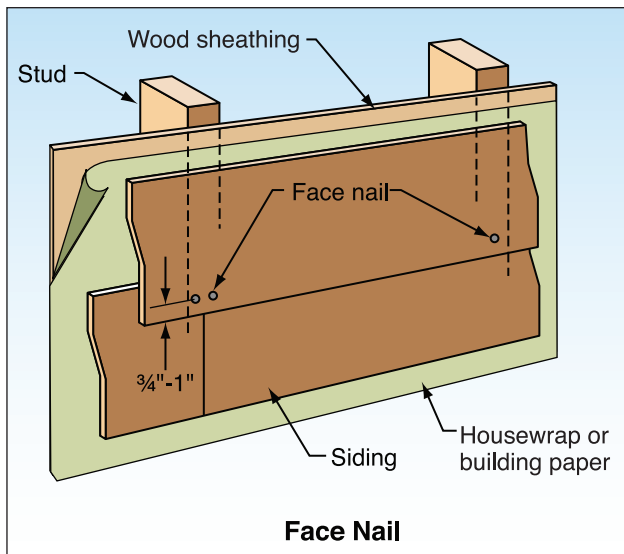


Figure 11. Face nailing.

- Face nailing (Figure 11) instead of blind nailing is recommended where the basic (design) wind speed is 100 mph or greater. If the local building code or manufacturer specifies face nailing at a lower wind speed, install accordingly.
- Do not leave the underside of the first course exposed or extending beyond the underlying material (Figure 12). Consider the use of a trim board to close off the underside of the first course.



Figure 12. Blind nailed siding installed with exposed gap at bottom (red circle) is vulnerable to failure.

## Sustainable Design

### Material selection for sustainable sources and durability

For wood products, it is best to select material that has been certified by a recognized program such as the American Tree Farm System® (ATFS), the Forest Stewardship Council (FSC) or the Sustainable Forestry Initiative® (SFI). Not only do these programs verify that wood is harvested in a more responsible fashion, but they also verify that the use of chemicals and genetic engineering of these products is avoided.

### The following publications discuss sustainable aspects of vinyl siding:

A Dozen Things You Might Not Know That Make Vinyl Siding Green (available online at [http://vinylsiding.org/greenpaper/090710\\_Latest\\_Revised\\_Green\\_paper.pdf](http://vinylsiding.org/greenpaper/090710_Latest_Revised_Green_paper.pdf)).

Siding with the Environment (available online at [http://www.vinylsiding.org/publications/final\\_Enviro\\_single\\_pg.pdf](http://www.vinylsiding.org/publications/final_Enviro_single_pg.pdf)).

## Energy Conservation and Air Barriers

Uncontrolled air leakage through the building envelope is often overlooked. The U.S. Department of Energy estimates that 40 percent of the cost of heating or cooling the average American home is lost due to uncontrolled air leakage. In warmer climates, it is a lower percentage of loss. An air barrier system can reduce the heating, ventilation, and cooling (HVAC) system size, resulting in reduced energy use and demand.

Uncontrolled air leakage can also contribute to premature deterioration of building materials, mold and moisture problems, poor indoor air quality, and compromised occupant comfort. When uncontrolled air flows through the building envelope, water vapor moves with it. Controlling the movement of moisture by air infiltration requires controlling the air pathways and/or the driving force.

To effectively control air leakage through the building envelope, an effective air barrier is required. To be effective, it needs to be continuous; therefore, air barrier joints need to be sealed and the barrier needs to be sealed at penetrations through it. The Air Barrier Association of America recommends that materials used as a component of a building envelope air barrier be tested to have an air infiltration rate of less than 0.004 cubic feet per minute (cfm)/square foot, assemblies of materials that form the air barrier be tested to have an air infiltration rate of less than 0.04 cfm/square foot, and the whole building exterior enclosure have an air infiltration rate of less than 0.4 cfm/square foot.

### Air Barrier Systems Installed Behind Siding

Housewrap is the most common air barrier material for residential walls. To be effective, it is critical that the joints between sheets of housewrap be sealed as recommended by the manufacturer, and penetrations (other than fasteners) should also be sealed. At transitions between the housewrap and door and window frame, use of self-adhering modified bitumen flashing tape is recommended.

An air barrier should be installed over a rigid material, or it will not function properly. It also needs to be restrained from pulling off of the wall under negative wind pressures. For walls, wood sheathing serves as a suitable substrate, and the siding (or furring strips in a rain screen wall system) provide sufficient restraint for the air barrier.

At the base of the wall, the wall air barrier should be sealed to the foundation wall. If the house is elevated on piles, the wall barrier should be sealed to an air barrier installed at the plane of the floor.

If the building has a ventilated attic, at the top of the wall, the wall air barrier should be sealed to an air barrier that is installed at the plane of the ceiling.

**Air barrier:** A component installed to provide a continuous barrier to the movement of air through the building envelope. Housewrap is a common air barrier material for residential walls. Although very resistant to airflow, housewrap is very vapor permeable and therefore is not suitable for use as a vapor retarder.

**Vapor retarder:** A component installed to resist diffusion of water vapor and provide a continuous barrier to movement of air through the building envelope. Polyethylene is a common vapor retarder material for residential walls. To determine whether or not a vapor retarder is needed, refer to the appropriate provisions of Chapter 14 of the 2009 IBC or Chapter 6 of the 2009 IRC. Also refer to the Moisture Control section of the NRCA Roofing and Waterproofing Manual, published by the National Roofing Contractors Association (NRCA) (<http://www.nrca.net>).

ASTM E 1677, *Standard Specification for an Air Retarder (AR) Material or System for Low-Rise Framed Building Walls*: This specification covers the minimum performance and acceptance criteria for an air barrier material or system for framed walls of low-rise buildings with the service life of the building wall in mind. The provisions contained in this specification are intended to allow the user to design the wall performance criteria and increase air barrier specifications to accommodate a particular climate location, function, or design of the intended building.

If the building has an unventilated attic or no attic, at the top of the wall, the wall air barrier should be sealed to an air barrier that is installed at the plane of the roof (the roof air barrier may be the roof membrane itself or a separate air barrier element).

### Siding Maintenance

For all siding products, it is very important to periodically inspect and maintain the product especially in a coastal environment. This includes recoating on a scheduled maintenance plan that is necessary according to the manufacturer's instructions and a periodic check of the sealant to ensure its durability. Check the sealant for its proper resiliency and that it is still in place. Sealant should be replaced before it reaches the end of its service life.

## Additional Resources

American Tree Farm System®, ATFS (<http://www.treefarmssystem.org/index.shtml>).

Forest Stewardship Council, FSC (<http://www.fsc-info.org>)

International Code Council. International Building Code. 2009. (<http://www.iccsafe.org>)

International Code Council. International Residential Code. 2009. (<http://www.iccsafe.org>)

Sustainable Forestry Initiative® Program, SFI (<http://www.sfiprogram.org>)

Vinyl Siding Institute, VSI (<http://www.vinylsiding.org>)



# Attachment of Brick Veneer in High-Wind Regions

**Purpose:** *To recommend practices for installing brick veneer that will enhance wind resistance in high-wind regions (i.e., greater than 90-miles per hour [mph] basic [gust design] wind speed).<sup>1</sup>*

## Key Issues

- When not adequately attached, brick veneer is frequently blown off walls of residential and non-residential buildings during hurricanes (Figure 1). When brick veneer fails, wind-driven water can enter and damage buildings, and building occupants can be vulnerable to injury from windborne debris (particularly if walls are sheathed with plastic foam insulation or wood fiberboard instead of wood panels). Pedestrians in the vicinity of damaged walls can also be vulnerable to injury from falling veneer (Figure 2).
- Common failure modes include tie (anchor) corrosion (Figure 3), tie fastener pull-out (Figure 4), failure of masons to embed ties into the mortar (Figure 5), and poor bonding between ties and mortar and mortar of poor quality (Figure 6).
- Ties are often installed before brick laying begins. When this is done, ties are often improperly placed above or below the mortar joints. When misaligned, the ties must be angled up or down in order for the ties to be embedded into the mortar joints (Figure 7). Misalignment not only reduces embedment depth, but also reduces the effectiveness of the ties because wind forces do not act parallel to the ties themselves.
- Corrugated ties typically used in residential veneer construction provide little resistance to compressive loads. Use of compression struts would likely be beneficial, but off-the-shelf devices do not currently exist. Two-piece adjustable ties (Figure 8) provide significantly greater compressive strength than corrugated ties and are, therefore, recommended. However, if corrugated ties are used, it is recommended that they be installed as shown in Figures 9 and 10 in order to enhance their wind performance.

<sup>1</sup> The 90 mph speed is based on ASCE 7-05. If ASCE 7-10 is being used, the equivalent wind speed trigger is 115 mph for Risk Category II buildings.



**Figure 1.** Failed brick veneer over plywood. Many of the ties are still attached to the substrate, but several of the tie fasteners pulled out of the substrate and the ties are embedded in the collapsed veneer. Estimated wind speed: 107 miles per hour (peak gust, Exposure C, at 33 feet).



**Figure 2.** The upper portion of the brick veneer at this apartment building collapsed. Pedestrian and vehicular traffic in the vicinity of the damaged wall are vulnerable to injury and damage if remaining portions of the wall were to collapse during subsequent storms.





**Figure 3. Significant tie corrosion caused the brick at a fire station to fail, even though the building is not near the coast. Note that metal is missing for half of the width of the tie at two locations (red arrows). The left end of the tie was still embedded into a concrete masonry unit back-up wall. The right end is where the tie failed in tension, thus leaving a portion of the tie embedded in the collapsed brick.**



**Figure 4. This tie remained embedded in the mortar joint while the smooth-shank nail pulled out from the stud.**



**Figure 5. These four ties were never embedded into the mortar joint.**

- Buildings that experience veneer damage typically do not comply with current building codes. Building code requirements for brick veneer have changed over the years. Model codes prior to 1995 permitted brick veneer in any location, with no wind speed restrictions. Also, some older model codes allowed brick veneers to be anchored with fewer ties than what is required by today's standards.

The Masonry Society's (TMS) 402/American Concrete Institute 530/American Society of Civil Engineers (ASCE) 5 *Building Code Requirements and Specifications for Masonry Structures* (TMS 402) is the current masonry standard referenced by model building codes. The 2009 International Residential Code (IRC) and the 2009 International Building Code (IBC) references the 2008 edition of TMS 402, which is the latest edition.

TMS 402 addresses brick veneer in two manners: rational design and a prescriptive approach. Nearly all brick veneer in residential and low-rise construction follows the prescriptive approach. The first edition of TMS 402 limited the use of prescriptive design to areas with a basic wind speed of 110 mph or less. The 2008 edition of TMS 402 extended the prescriptive requirements to include a basic wind speed of 130 mph, but limits the veneer wall area per tie that can be anchored with veneer ties to 70 percent of that allowed in lower wind speed regions. The 2008 edition requires rational design approaches in locations where the basic wind speeds exceed 130 mph.

Some noteworthy distinctions exist in the requirements for anchored brick veneer between the 2005 and the 2008 editions of TMS 402. For lower wind speed regions (110 mph and below), TMS 402-05 limited the vertical spacing of ties to 18 inches; the 2008 edition allows vertical ties to be spaced up to 25 inches, provided the wall area of veneer anchored per tie does not exceed 2.67 square feet. In TMS's high-wind regions (over 110 mph and up to 130 mph), both editions of the code limit vertical spacing to 18 inches. TMS 402-08 also limits the space between veneer anchored with corrugated ties and the wall sheathing to 1 inch. This is to avoid compression failures in the corrugated ties when they are exposed to positive pressures.

- The following Brick Industry Association (BIA) Technical Notes provide guidance on brick veneer: Technical Notes 28 – Anchored Brick Veneer, Wood Frame Construction; Technical Notes 28B – Brick Veneer/Steel Stud Walls; and Technical Notes 44B – Wall Ties. Although these Technical Notes provide attachment recommendations, the recommendations are inadequate because they are not specific for high-wind regions.

#### 5.4: ATTACHMENT OF BRICK VENEER IN HIGH WIND REGIONS

### HOME BUILDER'S GUIDE TO COASTAL CONSTRUCTION

## Construction Guidance

The brick veneer wall system is complex in its behavior. There are limited test data on which to draw. The following guidance is based on professional judgment, wind loads specified in ASCE 7-10, *Minimum Design Loads for Buildings and Other Structures*, fastener strengths specified in the American Forest and Paper Association's (AF&PA's) National Design Specification (NDS) for Wood Construction, and brick veneer standards contained in TMS 402-08. In addition to the general guidance given in BIA Technical Notes 28 and 28B, the following guidelines are recommended:

**Tie Spacing:** The ability for Brick Ties and Tie Fasteners to function properly is highly dependent on horizontal and vertical spacing of ties. Horizontal spacing of ties will often coincide with stud spacing of either 16-inch or 24-inch on center (see Table 1) because tie fasteners are required to be installed directly into framing. Spacing of ties horizontally and vertically must not exceed a) spacings which will overload the tie or tie fastener based on a tributary area of wind pressure on the brick veneer, or b) prescriptive limits on spacing of ties. More information on horizontal and vertical tie spacing is available in Table 1.

**Tie Fasteners:** 8d (0.131" diameter) ring-shank nails are recommended instead of smooth-shank nails. A minimum embedment of 2 inches into framing is suggested.

**Ties:** For use with wood studs, two-piece adjustable ties are recommended. However, where corrugated steel ties are used, use 22-gauge minimum, 7/8 by 6 inches, complying with American Society for Testing and Materials (ASTM) A 366 with a zinc coating complying with ASTM A 153 Class B2. For ties for use with steel studs, see BIA Technical Notes 28B – Brick Veneer/Steel Stud Walls. Stainless steel ties



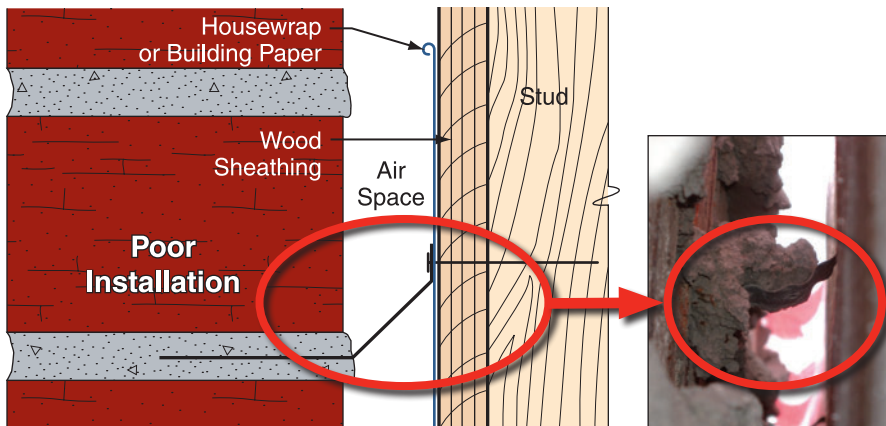
**Figure 6.** This tie was embedded in the mortar, but the bond was poor.

should be used in areas within 3,000 feet of the coast.

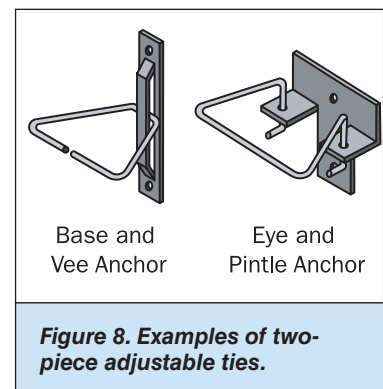
Note: In areas that are also susceptible to high seismic loads, brick veneer should be evaluated by an engineer to ensure that it can resist seismic and wind design loads.

## Sustainability

Brick veneer can offer a very long service life, provided the ties are not weakened by corrosion. To help ensure that brick veneer achieves its long life potential, in addition to properly designing and installing the ties, stainless steel ties are recommended.



**Figure 7.** Misalignment of the tie reduces the embedment and promotes veneer failure.



**Figure 8.** Examples of two-piece adjustable ties.

## Tie Installation

- Install ties as the brick is laid so that the ties are properly aligned with the brick coursing. Alternatively, instead of installing ties as the brick is laid, measure the locations of the brick coursing, snap chalk lines, and install ties so that they are properly aligned with the coursing, and then install the brick.
- Install brick ties spaced based on the appropriate wind speed and stud spacing shown in Table 1. In areas where the 2006 Edition of the IBC or IRC are adopted, install brick veneer ties as noted in Table 1 but with a maximum vertical spacing of no more than 18 inches to satisfy the requirements of TMS 402-05.
- Locate ties within 8 inches of door and window openings and within 12 inches of the top of veneer sections.
- Bend the ties at a 90-degree angle at the nail head in order to minimize tie flexing when the ties are loaded in tension or compression (Figure 9).
- Embed ties in joints so that mortar completely encapsulates the ties. Embed a minimum of 1 1/2 inches into the bed joint, with a minimum mortar cover of 5/8 inch to the outside face of the wall (Figure 10).

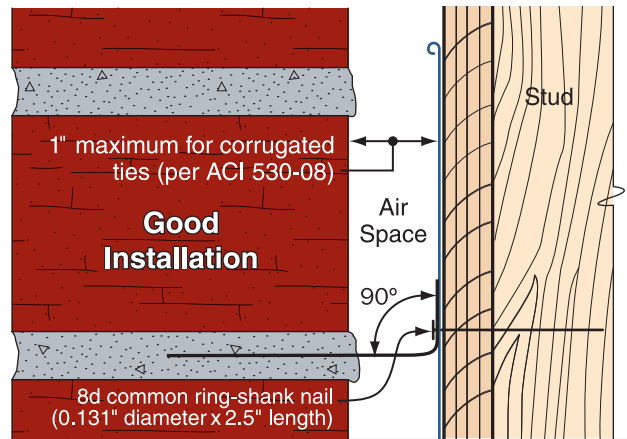


Figure 9. Bend ties at nail heads.

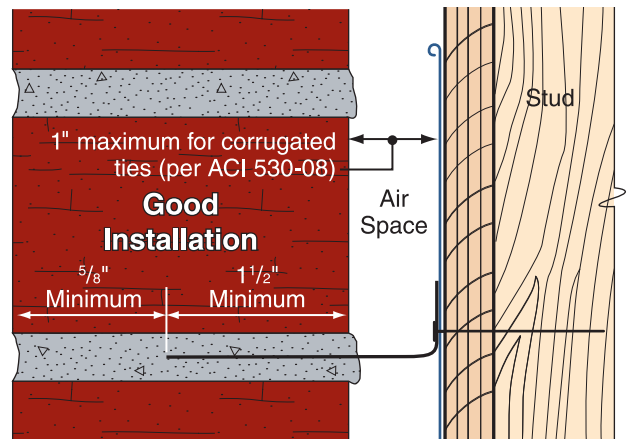


Figure 10. Tie embedment.

**Table 1. Brick Veneer Tie Spacing**

Wind Speed (mph) (3-Second Peak Gust)	Wind Pressure (psf)	Maximum Vertical Spacing for Ties (inches)	
		16" stud spacing	24" stud spacing
90	-19.5	24 <sup>a,b</sup>	16 <sup>a</sup>
100	-24.1	24 <sup>a,b</sup>	16 <sup>a</sup>
110	-29.1	20½ <sup>b</sup>	13½
120	-34.7	17	NA <sup>c</sup>
130	-40.7	15	NA <sup>c</sup>
140	-47.2	13	NA <sup>c</sup>
150	-54.2	11	NA <sup>c</sup>

**Notes:**

1. The tie spacing is based on wind loads derived from Method 1 of ASCE 7-05, for the corner area of buildings up to 30' high, located in Exposure B with an importance factor (I) of 1.0 and no topographic influence. For other heights, exposures, or importance factors, engineered designs are recommended.
2. Spacing is for 2½" long 8d common (0.131" diameter) ring-shank fasteners embedded 2" into framing. Fastener strength is for wall framing with a Specific Gravity G=0.55 with moisture contents less than 19 percent and the following adjustment factors, C<sub>f</sub>=0.8; and C<sub>D</sub>, C<sub>M</sub>, C<sub>eg</sub>, and C<sub>tn</sub>=1.0. Factored withdrawal strength W'<sub>f</sub>=65.6#.
3. The brick veneer tie spacing table is based on fastener loads only and does not take into account the adequacy of wall framing, sheathing, and other building elements to resist wind pressures and control deflections from a high-wind event. Prior to repairing damaged brick veneer, the adequacy of wall framing, wall sheathing, and connections should be verified by an engineer.
  - a Maximum spacing allowed by ACI 530-08.
  - b In locales that have adopted the 2006 IBC/IRC, the maximum vertical spacing allowed by ACI 530-05 is 18".
  - c 24" stud spacing exceeds the maximum horizontal tie spacing of ACI 530-08 prescribed for wind speeds over 110 mph.

**Additional Resources**

Brick Industry Association (BIA). (<http://www.gobrick.com>)

- Technical Notes 28 – Anchored Brick Veneer, Wood Frame Construction
- Technical Notes 28B – Brick Veneer/Steel Stud Walls
- Technical Notes 44B – Wall Ties

*Developed in association with the National Association of Home Builders Research Center*





# Window and Door Installation

**Purpose:** To provide flashing detail concepts for window and door openings that:

- give adequate resistance to water intrusion in coastal environs,
- do not depend solely on sealants,
- are integral with secondary weather barriers (i.e., housewrap or building paper – see Fact Sheet No. 5.1), and
- are adequately attached to the wall.

## Key Issues

Water intrusion around window and door openings can cause dry rot and fastener corrosion that weaken the window or door frame or the wall itself, and lead to water damage to interior finishes, mold growth, and preventable building damage during coastal storms. Proper flashing sequence must be coordinated across responsibilities sometimes divided between two or more trade activities (e.g., weather barrier, window, and siding installation).

To combat wind-driven rain penetration and high wind pressures, window and door frames must be adequately attached to walls and they must be adequately integrated with the wall's moisture barrier system (see Fact Sheet No. 1.9).

## ASTM E 2112

Detailed information about window and door installation is provided in the American Society for Testing and Materials (ASTM) standard ASTM E 2112, a comprehensive installation guide intended for use in training instructors who in turn train the mechanics who actually perform window and door installation. The standard concentrates on detailing and installation procedures that are aimed at minimizing water infiltration.

The standard includes a variety of window and door details. The designer should select the details deemed appropriate and modify them if necessary to meet local weather conditions, and the installer should execute the selected details as specified in the standard or as modified by the designer.

Section 1.5 states that if the manufacturer's instructions conflict with E 2112, the manufacturer's instructions shall prevail. However, because a manufacturer's instructions may be inferior to the guidance provided in the standard, any conflict between the manufacturer's requirements and the standard or contract documents should be discussed among and resolved by the manufacturer, designer, and builder.

## Specific Considerations

**Pan flashings:** Windows that do not have nailing flanges, and doors, are typically installed over a pan flashing (see Figure 1). Section 5.16 of ASTM E 2112 discusses pan flashings and refers to Annex 3 for minimum heights of the end dam and rear leg. Annex 3 shows a maximum end dam height of 2 inches, which is too low for areas prone to very high winds (i.e., wind speed greater than 110 mph). Where the wind speed is greater than 110 mph, the end dam should be 3 to 4 inches high (the higher the wind speed, the higher the dam). (Note: Annex 3 says that "high rain and wind are usually not simultaneous." However, this statement is untrue for coastal storms, in which extremely high amounts of rain often accompany very high winds.)

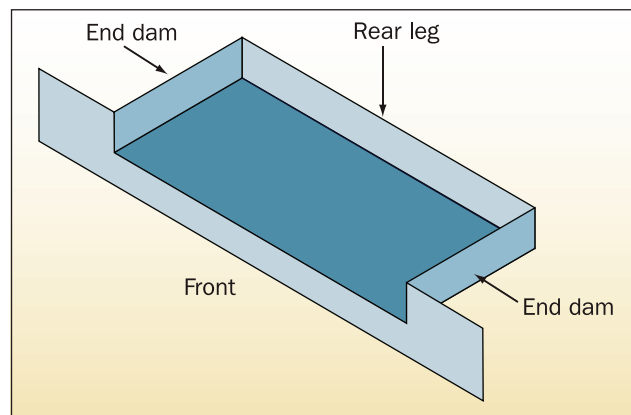


Figure 1. Pan Flashing



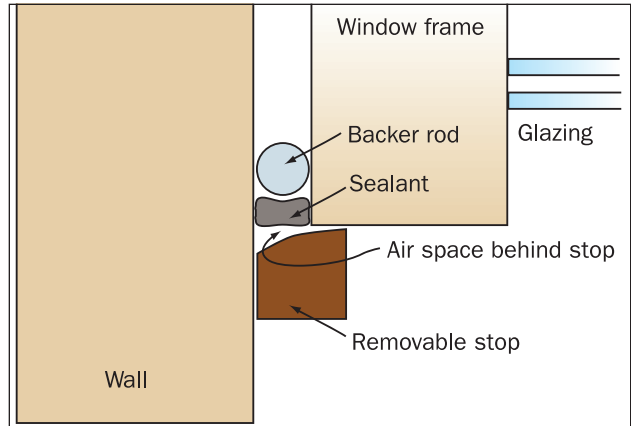
Although not discussed in ASTM E 2112, for installations that require an exposed sealant joint, installation of a removable stop (see Figure 2) is recommended to protect the sealant from direct exposure to the weather and reduce the wind-driven rain demand on the sealant.

**Exterior Insulation Finishing Systems (EIFS):** Although not discussed in ASTM E 2112, when a window or door assembly is installed in an EIFS wall assembly, sealant between the window or door frame and the EIFS should be applied to the EIFS base coat. After sealant application, the top coat is then applied. (The top coat is somewhat porous; if sealant is applied to it, water can migrate between the top and base coats and escape past the sealant.)

**Frame anchoring:** Window and door frames should be anchored to the wall with the type and number of fasteners specified by the designer.

**Shutters:** If shutters are installed, they should be anchored to the wall, rather than the window or door frame (see Figure 3).

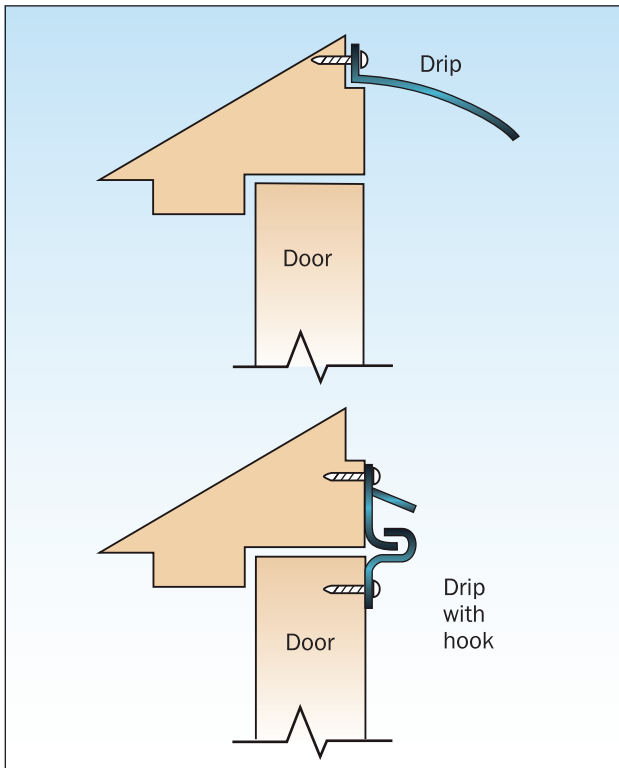
**Weatherstripping:** E 2112 does not address door weatherstripping. However, weatherstripping is necessary to avoid wind-driven rain penetration. A variety of weatherstripping products are available as shown in Figures 4 through 9.



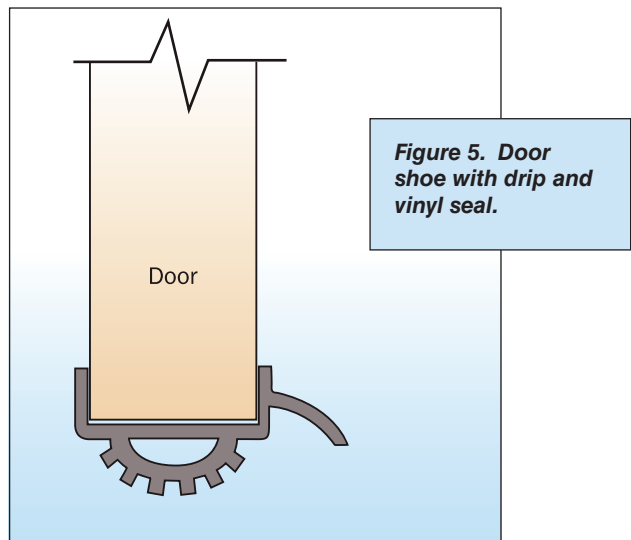
**Figure 2. Protection of sealant with a stop.**



**Figure 3. Hurricane Georges in Puerto Rico.** The window lying on the ground was protected by a shutter. However, the shutter was attached to the window frame. The window frame fasteners were over-stressed and the entire assembly failed. Attachment of the shutter directly to the wall framing is a more reliable method of attachment.

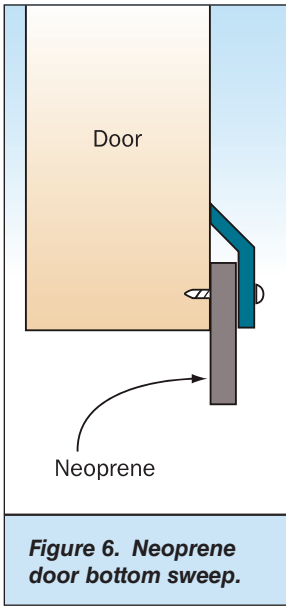


**Figure 4. Drip at door head and drip with hook at head**

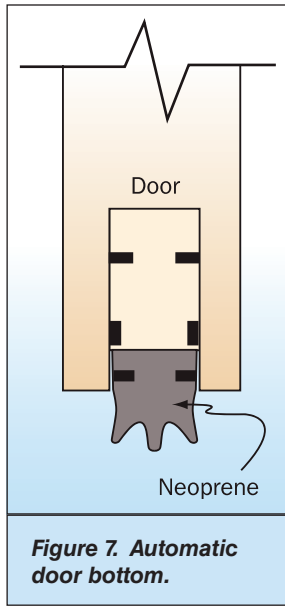


**Figure 5. Door shoe with drip and vinyl seal.**

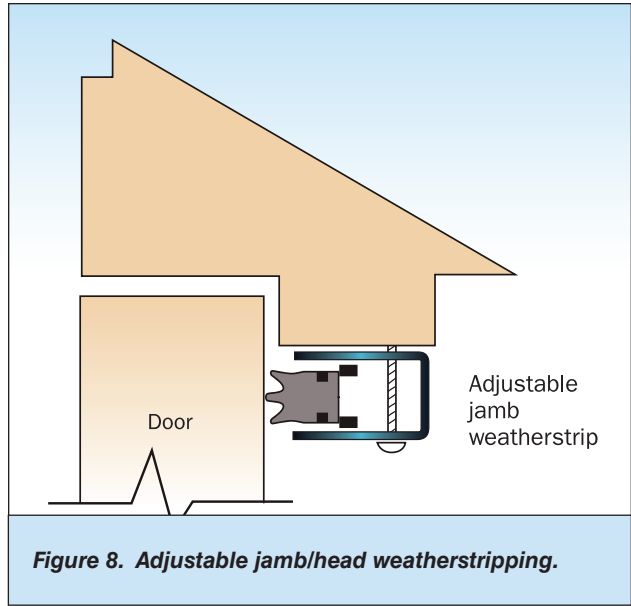




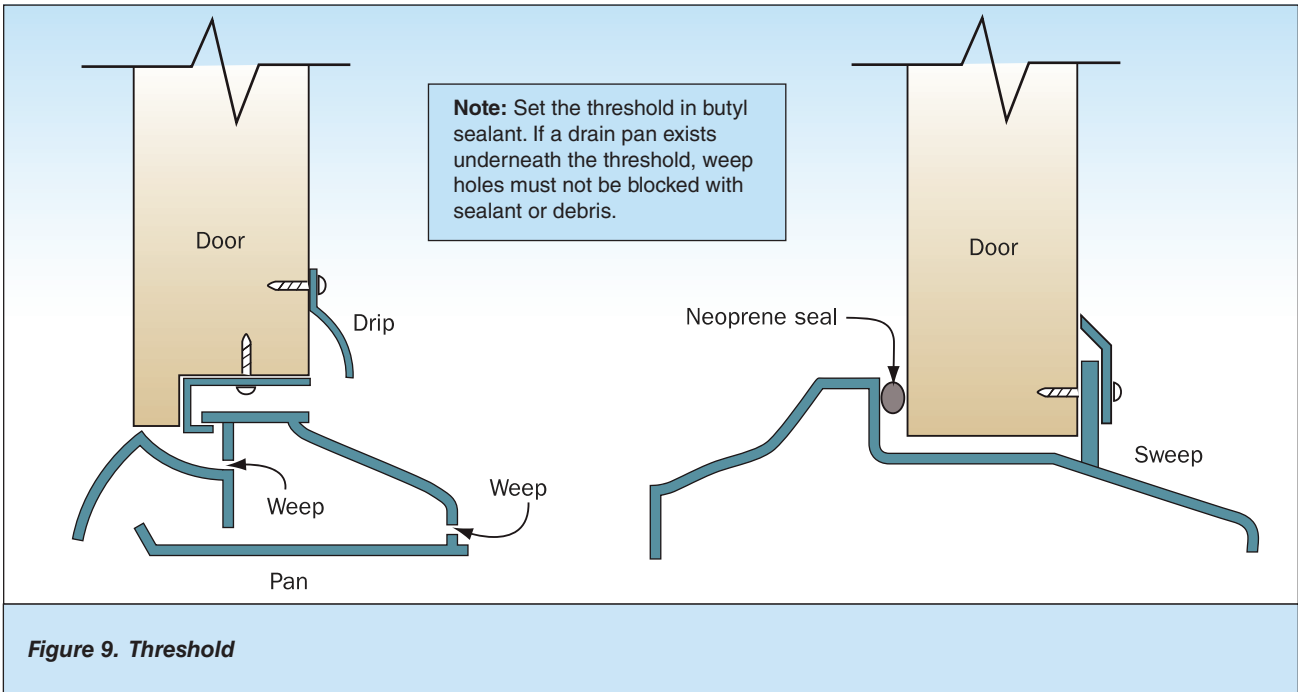
**Figure 6. Neoprene door bottom sweep.**



**Figure 7. Automatic door bottom.**



**Figure 8. Adjustable jamb/head weatherstripping.**



**Figure 9. Threshold**

### Additional Resources

American Society for Testing and Materials. ASTM E 2112, *Standard Practice for Installation of Exterior Windows, Doors and Skylights*. ([www.astm.org](http://www.astm.org))

Developed in association with the National Association of Home Builders Research Center





# Protection of Openings— Shutters and Glazing

**Purpose:** *To provide general information about the selection and installation of storm shutters and impact-resistant glazing and other types of opening protection in windborne debris regions.*

## Opening Requirements in Codes and Standards

### What Are “Hurricane-Prone Regions” and “Windborne Debris Regions”?

According to the 2009 International Building Code (IBC) and the 2009 International Residential Code (IRC), **hurricane-prone regions** are areas vulnerable to hurricanes such as:

1. The U.S. Atlantic Ocean and Gulf of Mexico coasts where the basic wind speed is greater than 90 mph<sup>1</sup> (40 m/s).
2. Hawaii, Puerto Rico, Guam, the U.S. Virgin Islands, and American Samoa.

**Wind-borne debris regions** are defined as areas with in portions of hurricane-prone regions located within 1 mile (1.61 km) of the coastal mean high water line where the basic wind speed is 110 mph (48 m/s)<sup>1</sup> or greater; or portions of hurricane-prone regions where the basic wind speed is 120 mph (53 m/s)<sup>1</sup> or greater; or Hawaii.

Sections 1609.1.2 and R301.2.1.2, of the 2009 editions of the IBC and IRC, respectively, address the Protection of Openings. These sections state that in wind-borne debris regions, glazing in buildings shall be impact resistant or protected with an impact-resistant covering that meets the requirements of an approved impact-resistant standard or the American Society of Testing and Materials (ASTM) standards ASTM E 1996 and ASTM E 1886. Wood structural panels could be used as an alternative to provide protection so long as they meet local building code requirements. Panel attachment should be in accordance with Table 1609.1.2 (IBC) and Table R301.2.1.2 (IRC) and installed using corrosion-resistant attachment hardware and anchors permanently installed on the building. Under provisions of the IBC, wood structural panels are permitted for Group R-3 and R-4 buildings with a mean roof height of 45 feet (13,716 mm) or less where wind speeds do not exceed 140 mph (63 m/s). Under provisions of the



**Figure 1.** *Wood structural panels installed in accordance with building code requirements are a cost-effective means of protection, but they should be adequately attached so they themselves do not become windborne debris.*

IRC, wood structural panels are permitted for buildings with a mean roof height of 33 feet (10,058 mm) or less where wind speeds do not exceed 130 mph<sup>2</sup> (58 m/s). Figure 1 shows a house utilizing wood structural panels to provide opening protection.

ASCE/SEI 7-05 also discusses the protection of glazed openings in Section 6.5.9.3. The section states, “Glazing in buildings located in wind-borne debris regions shall be protected with an impact-protective system or be impact-resistant glazing according to the requirements specified in ASTM E1886 and ASTM E1996 or other approved test methods and performance criteria. The levels of impact resistance shall be a function of Missile Levels and Wind Zones specified in ASTM E 1886 and ASTM E 1996”. Exceptions to this are noted in Section 6.5.9.3.

<sup>1</sup> ASCE 7-05 wind speed – in order to recalculate this for ASCE 7-10 divide the ASCE 7-05 wind speed by 0.6<sup>0.5</sup>



## Anchorage

Window and door assemblies must be strong enough to withstand wind pressures acting on them and be fastened securely enough to transfer those wind pressures to the adjacent wall. Pressure failures of doors or windows can allow glazing to fracture or glazing frames or supports to fail. Anchorage failures can allow entire door or window units to be ripped from the walls. Either type of failure results in the failure of the building envelope and allows wind and water to enter the building.

## Shutters

### Why Are Storm Shutters Needed?

If glazing is not resistant to windborne debris, then shutters are an important part of a hurricane-resistant home. They provide protection for glass doors and windows against windborne debris, which is often present in hurricanes. Keeping the building envelope intact (i.e., no window or door breakage) is vital to the integrity of a home. If the envelope is breached, sudden pressurization of the interior may result in major structural or non-structural damage (e.g., roof loss) and will lead to significant interior and contents damage from wind-driven rain. The addition of shutters will not eliminate the potential for wind-driven rain entering the building, but will improve the building's resistance to it.



**Figure 2. Metal panel shutter .** The shutter is installed in a track permanently mounted above and below the window frame. The shutter is placed in the track and secured with wing nuts to studs mounted on the track. This type of shutter is effective and quickly installed, and the wing nut and stud system provides a secure anchoring method. Track designs that have permanently mounted studs for the nuts have been shown to be more reliable than track designs using studs that slide into the track.

**Note:** When glazing protection is provided by shutters, screens, or other panel systems, the glazing and glazing frame should be designed and constructed to resist the full design loads (i.e., do not assume that the shutter will be decreasing the wind pressure on the glazing). Also note that it should be assumed that the shutter will not significantly decrease the wind-driven rain demand on the glazed assembly.

### Where Are Storm Shutters Required and Recommended?

Model building codes, which incorporate wind provisions from ASCE 7 (1998 edition and later), require that buildings within the **windborne debris region** (see Figure 5 of this fact sheet), either (1) be equipped with shutters or impact-resistant glazing and designed as enclosed structures or (2) be designed as partially enclosed structures (as if the windows and doors are broken out). However it should be noted that the alternative to design a Risk Category II building (defined in ASCE 7-10) as a partially enclosed structure was removed from ASCE 7-10 and it now requires that all Risk Category II structures in the wind-borne debris region be designed to be enclosed structures with impact-resistant glazing or equipped with a shutter system. It is also recommended to give strong consideration to the use of opening protection in all hurricane-prone areas where the basic wind speed is 100 mph (3-second gust speed) or greater, even though the IBC and IRC building codes do not require it. Designers should check with the jurisdiction to determine whether state or local requirements for opening protection exceed those of the model code.



**WARNING:** A shutter may look like it is capable of withstanding windborne missiles; unless it is tested, however, its missile resistance is unknown.

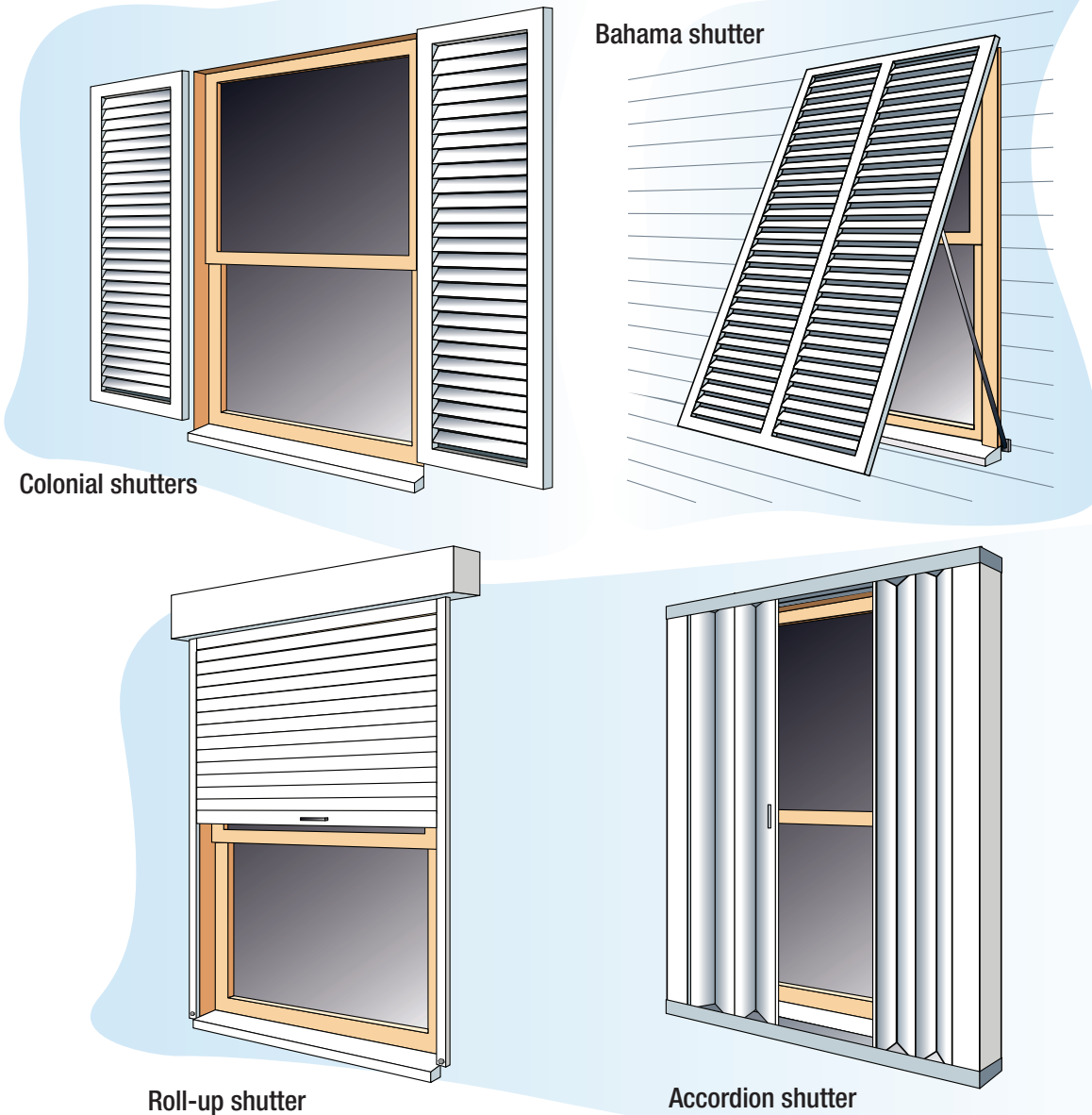
### What Types of Shutters Are Available?

A wide variety of shutter types are available, from the very expensive motor-driven, roll-up type, to the less expensive temporary wood structural panels. Designers can refer to Miami-Dade County, Florida, which has established a product approval mechanism for shutters and other building materials to ensure they are rated for particular wind and wind-borne debris loads (see the “Additional Resources” section). Figures 3 and 4 illustrate some of the shutter styles available.

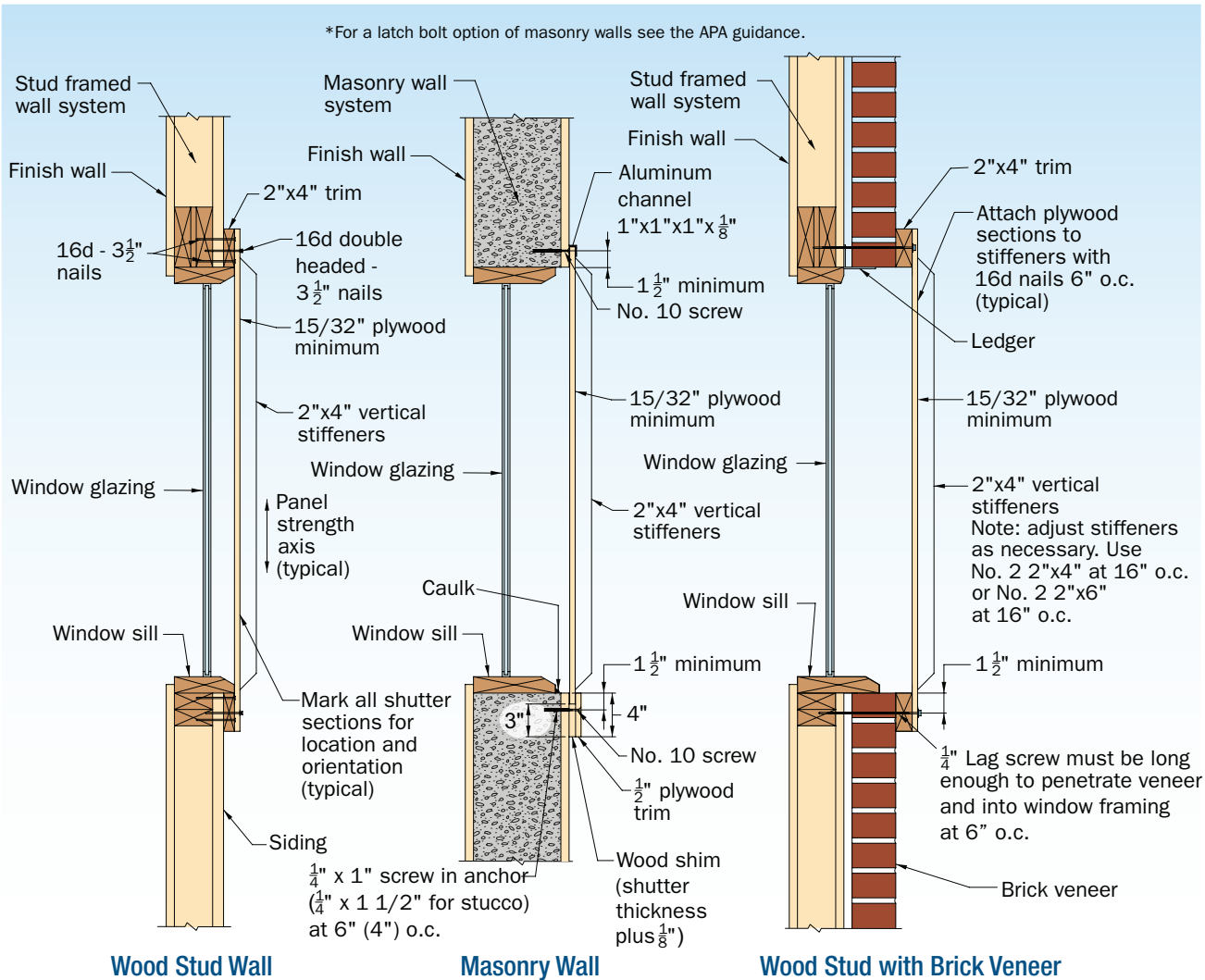
**Note:** Many coastal homes have large and unusually shaped windows, which will require expensive, custom shutters. Alternatively, such windows can be fabricated with laminated (impact-resistant) glass.

### Shutter Styles

Shutter styles include colonial, Bahama, roll-up, and accordion.



**Figure 3. Colonial shutters, Bahama style shutters, Roll-up style shutters, and Accordion style shutters.**



See APA Guidance for additional details and nail specifications.  
 Only for use on residential structures with a mean roof height of 45 feet or less.

**Figure 4. Common methods for plywood shutter attachment to wood-frame and masonry walls.**  
 (For actual shutter design, refer to design drawings or see the APA, Engineered Wood Association guidelines for constructing plywood shutters.)

**Shutter Type Cost Advantages**

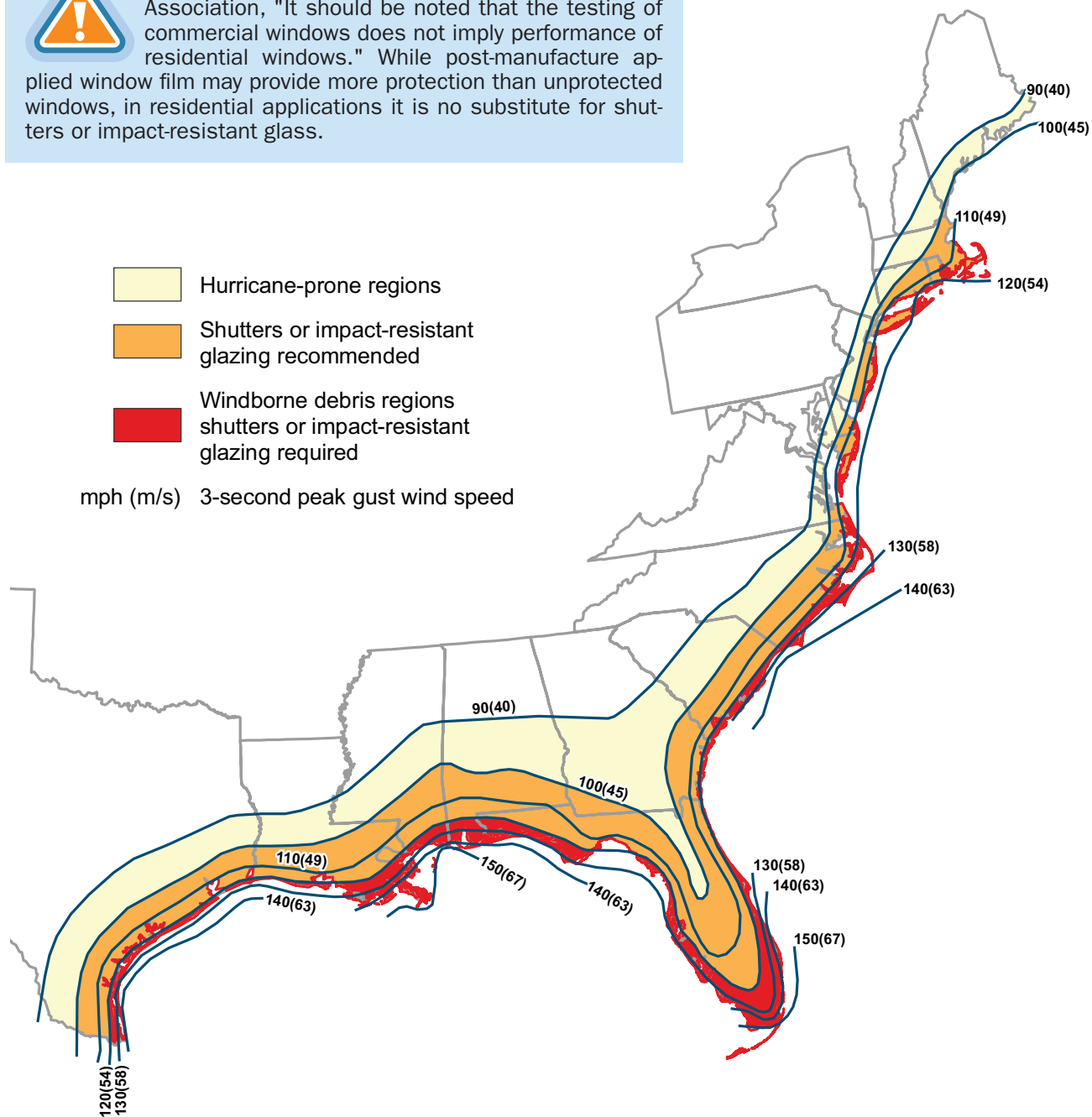
Shutter Type	Cost	Advantages	Disadvantages
Wood structural panels	Low	Inexpensive	Must be installed and taken down every time they are needed; must be adequately anchored to prevent blow-off; difficult to install on upper levels; storage space is needed.
Metal or polycarbonate panels	Low/Medium	Easily installed on lower levels	Must be installed and taken down every time they are needed; difficult to install on upper levels; storage space is needed.
Accordion, manual closing	Medium/High	Always in place; ready to be closed	Always in place; ready to be closed. Must be closed manually from the outside; difficult to access on upper levels.
Permanent, motor-driven	High	Easily opened and closed from the inside	Expensive. (It is important to find a motorized shutter that allows the shutter to be manually raised in order to allow the interior to vent following the storm and prior to electrical power restoration.)

## Are There Special Requirements for Shutters in Coastal Areas?

When installing any type of shutter, follow the manufacturer’s instructions and guidelines carefully. Be sure to attach the shutters to structurally adequate framing members (see shutter details in Figures 3 and 4 of this fact sheet). Avoid attaching the shutters to the window frame or brick veneer face. Always use hardware that is corrosive-resistant when installing shutters. Figure 5 is the ASCE 7-05 basic wind map for the East Coast of the United States. See page 1 of this fact sheet for the delineation of the areas where opening protection is required.



**WARNING:** According to the International Window Film Association, "It should be noted that the testing of commercial windows does not imply performance of residential windows." While post-manufacture applied window film may provide more protection than unprotected windows, in residential applications it is no substitute for shutters or impact-resistant glazing.



**Figure 5. An illustration of the ASCE 7-05 wind speed contours and windborne debris region. See ASCE 7-05 Figure 6-1 for wind load design.**

## Windborne debris resistant glazing

**Laminated glazing systems** typically consist of assemblies fabricated with two (or more) panes of glass and an interlayer of a polyvinyl butyral (or equivalent) film laminated into a glazing assembly. During impact testing, the laminated glass in the system can fracture but the interlayer must remain intact to prevent water and wind from entering the building. These systems may also increase the energy efficiency of the building over standard glazing.

**Polycarbonate systems** typically consist of plastic resins that are molded into sheets, which provide lightweight, clear glazing panels with high impact-resistance qualities. The strength of the polycarbonate sheets is much higher than non-laminated glass (i.e., more than 200 times stronger) or acrylic sheets or panels (i.e., more than 30 times stronger).

## Garage Doors

Garage doors many times represent large unreinforced openings. They are commonly damaged during high-wind events and could allow a building to be pressurized if they are breached. A garage door should meet the design wind speed requirements for the area or be retrofitted to withstand the design wind speed. However, the viability of a retrofit depends on the style and age of the door, and may not provide the same level of protection as a new door system.

The 2009 editions of IBC and IRC both comment on the glazing in garage doors in sections 1609.1.2.2 and R301.2.1.2, respectively. Any glazed opening protection on garage doors for wind-borne debris shall meet the requirements of an approved impact-resisting standard or ANSI/DASMA 115-2005.

While some manufacturers provide wind speed and exposure ratings for their products, labels on many garage doors do not include wind speed or wind pressure ratings. While not required to be included on the product labeling, ANSI/DASMA 108 does require that the positive and negative pressure used in testing be recorded on the ANSI/DASMA 108 Test Report Form. If the label attached to the door does not indicate the positive and negative pressure rating, consult the Test Report Form to verify it is an appropriate garage door for the area.

## Additional Resources

American Society of Civil Engineers. *Minimum Design Loads for Buildings and Other Structures*, ASCE/SEI 7-10. (<http://www.asce.org>)

The Engineered Wood Association (APA). *Hurricane Shutter Designs Set 5 of 5*. Hurricane shutter designs for woodframe and masonry buildings. (<http://www.apawood.org>)

International Code Council. *International Building Code*. 2009. (<http://www.iccsafe.org>)

International Code Council. *International Residential Code*. 2009. (<http://www.iccsafe.org>)

Information about product testing and approval process for Miami-Dade County, Florida, available at <http://www.miamidade.gov/buildingcode/product-control.asp>

American Society for Testing and Materials:

ASTM E1886, *Performance of Exterior Windows, Curtain Walls, Doors, and Storm Shutters Impacted by Missile(s) and Exposed to Cyclic Pressure Differentials*

ASTM E1996, *Standard Specification for Performance of Exterior Windows, Curtain Walls, Doors and Impact Protective Systems Impacted by Windborne Debris in Hurricane*

ASTM E2112, *Standard Practice for Installation of Exterior Windows, Doors and Skylights*

ASTM E330, *Structural Performance of Exterior Windows, Doors, Skylights and Curtain Walls by Uniform Static Air Pressure Difference*. (<http://www.astm.org>)

Door and Access Systems Manufacturers Association:

DASMA 108, *Standard Method for Testing Sectional Garage Doors: Determination of Structural Performance Under Uniform Static Air Pressure Difference*

Developed in association with the National Association of Home Builders Research Center



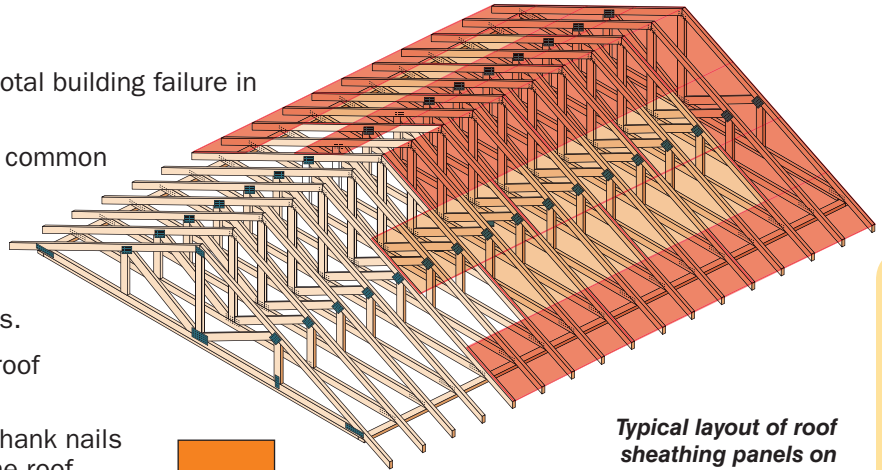


# Roof Sheathing Installation

**Purpose:** To provide information about proper roof sheathing installation, emphasize its importance in coastal construction, and illustrate fastening methods that will enhance the durability of a building in a high-wind area.

## Key Issues

- Insufficient fastening can lead to total building failure in a windstorm.
- Sheathing loss is one of the most common structural failures in hurricanes.
- Fastener spacing and size requirements for coastal construction are typically different than for non-coastal areas.
- The highest uplift forces occur at roof corners, edges, and ridge lines.
- Improved fasteners such as ring shank nails increase the uplift resistance of the roof sheathing.



Typical layout of roof sheathing panels on gable-end roof

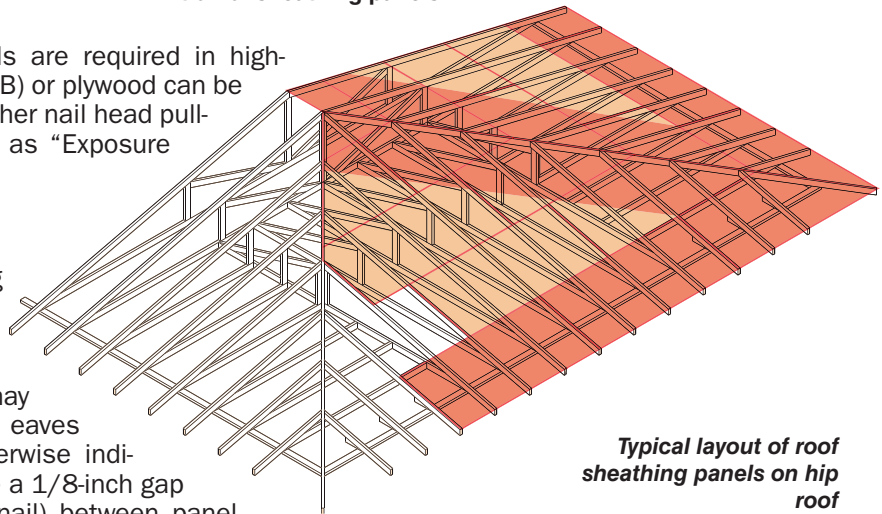
Most critical area for connection of sheathing panels

## Sheathing Type

Typically, 15/32-inch or thicker panels are required in high-wind areas. Oriented Strand Board (OSB) or plywood can be used, although plywood will provide higher nail head pull-through resistance. Use panels rated as “Exposure 1” or better.

## Sheathing Layout

Install sheathing panels according to the recommendations of the Engineered Wood Association (APA). Use panels no smaller than 4 feet long. Blocking of unsupported edges may be required near gables, ridges, and eaves (follow design drawings). Unless otherwise indicated by the panel manufacturer, leave a 1/8-inch gap (about the width of a 16d common nail) between panel edges to allow for expansion. (Structural sheathing is typically cut slightly short of 48 inches by 96 inches to allow for this expansion gap – look for a label that says “Sized for Spacing.”) This gap prevents buckling of panels due to moisture and thermal effects, a common problem.



Typical layout of roof sheathing panels on hip roof

## Fastener Selection

An 8d nail (2.5 inches long) is the minimum size nail to use for fastening sheathing panels. Full round heads are recommended to avoid head pull-through. Deformed-shank (i.e., ring- or screw-shank) nails are required near ridges, gables, and eaves in areas with design wind speeds over 110 mph (3-second gust), but it is recommended that deformed shank nails be used throughout the entire roof. If 8d “common” nails are specified, the nail diameter must be at least 0.131 inch (wider than typical 8d pneumatic nails). Screws can be used for



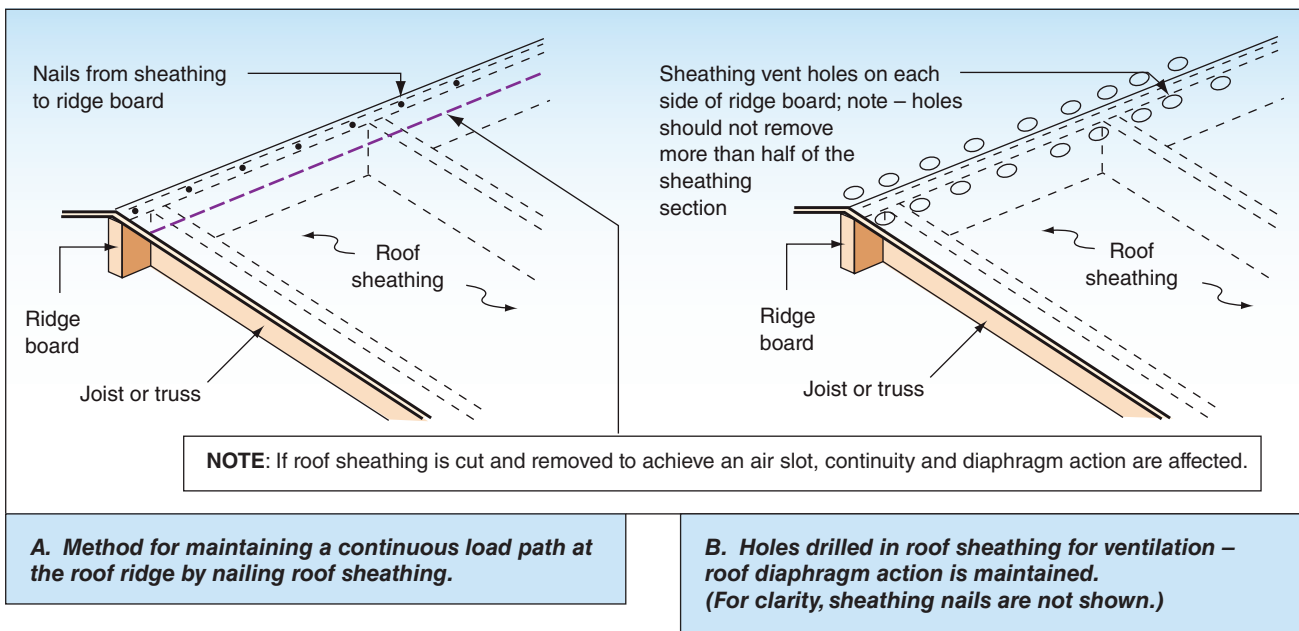
even greater withdrawal strength, but should be sized by the building designer. Staples are not recommended for roof sheathing attachment in high-wind areas.

## Fastener Spacing

It is **extremely important** to have proper fastener spacing on **all** panels. Loss of just one panel in a windstorm can lead to total building failure. Drawings should be checked to verify the required spacing; closer spacing may be required at corners, edges, and ridges. Visually inspect work after installation to ensure that fasteners have hit the framing members. Tighter fastener spacing schedules can be expected for homes built in high-wind areas. Installing fasteners at less than 3 inches on center can split framing members and significantly reduce fastener withdrawal capacity, unless 3-inch nominal framing is used and the nailing schedule is staggered.

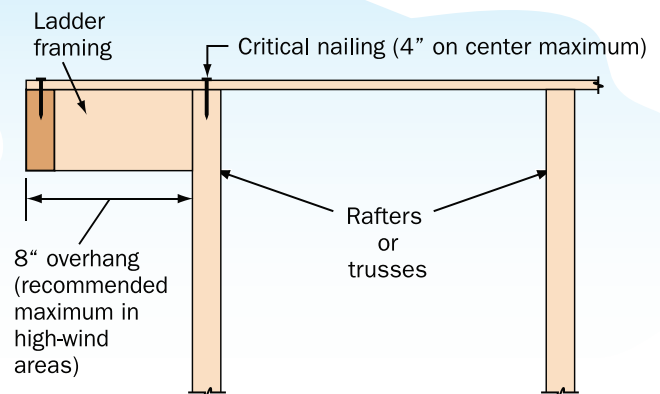
## Ridge Vents

When the roof sheathing is used as a structural diaphragm, as it typically is in high-wind and seismic hazard areas, the structural integrity of the diaphragm can be compromised by a continuous vent (see figure A., below left). Maintain ridge nailing by adding additional blocking set back from the ridge, or by using vent holes (see figure B., below right). Verify construction with a design professional.



## Ladder Framing at Gable Ends

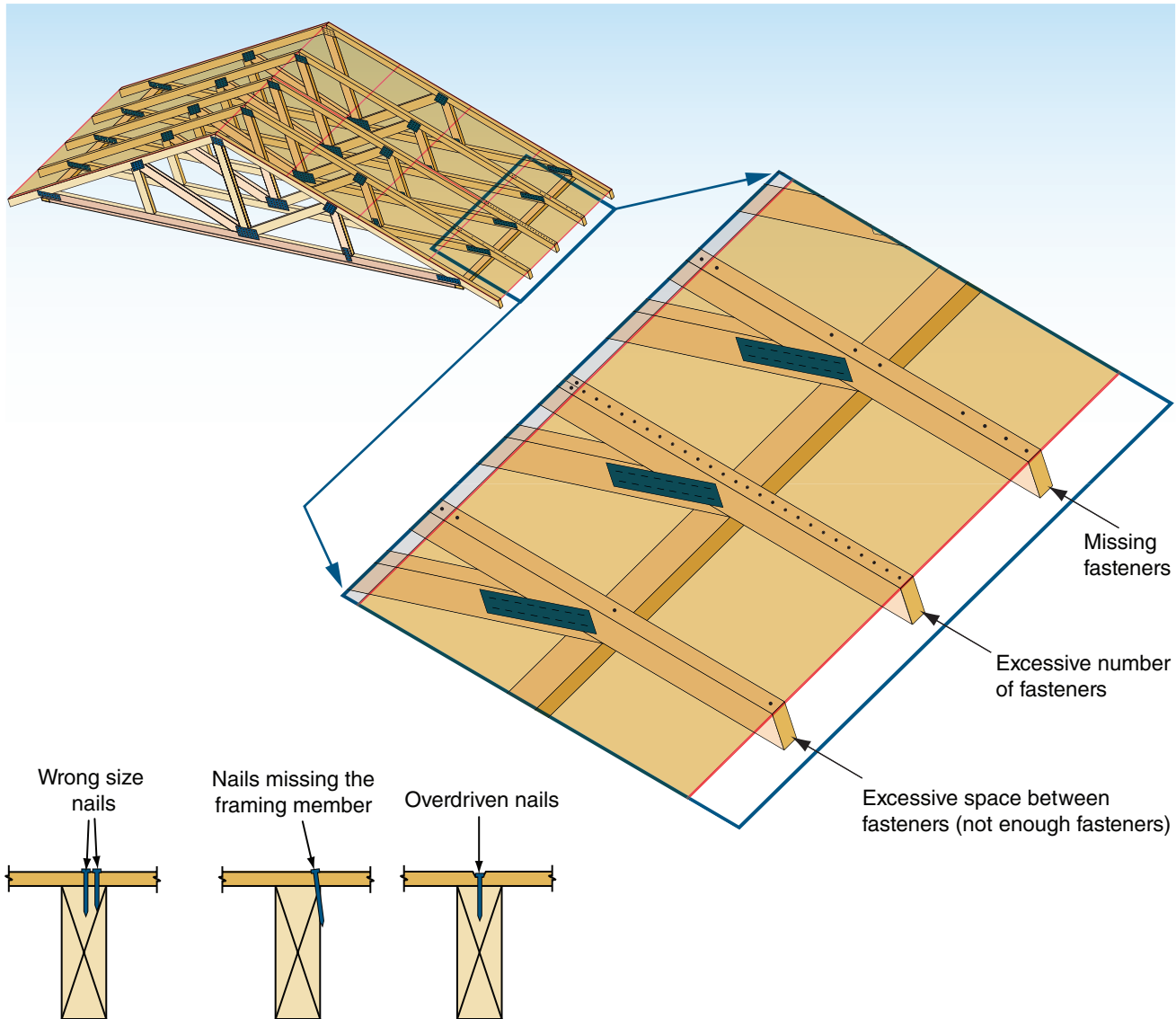
Use extra care when attaching a ladder-framed extension to a gable end. Many homes have been severely damaged by coastal storms because of inadequate connections between the roof sheathing and the gable truss. The critical fasteners occur at the gable-framing member, not necessarily at the edge of the sheathing. Nailing accuracy is crucial along this member. Tighter nail spacing is recommended (4 inches on center maximum).



**Ladder framing at gable ends.**

## Common Sheathing Attachment Mistakes

Common mistakes include using the wrong size fasteners, missing the framing members when installing fasteners, overdriving nails, and using too many or too few fasteners.



## Additional Resources

Engineered Wood Association (APA), ([www.apawood.org](http://www.apawood.org))

Developed in association with the National Association of Home Builders Research Center





# Roof Underlayment for Asphalt Shingle Roofs

**Purpose:** To provide recommended practices for use of roofing underlayment as an enhanced secondary water barrier in coastal environments.

**Note:** The underlayment options illustrated here are for asphalt shingle roofs. See FEMA publication 55, Coastal Construction Manual, for guidance concerning underlayment for other types of roofs.

## Key Issues

- Verifying proper attachment of roof sheathing before installing underlayment.
- Lapping and fastening of underlayment and roof edge flashing.
- Selecting underlayment material type.

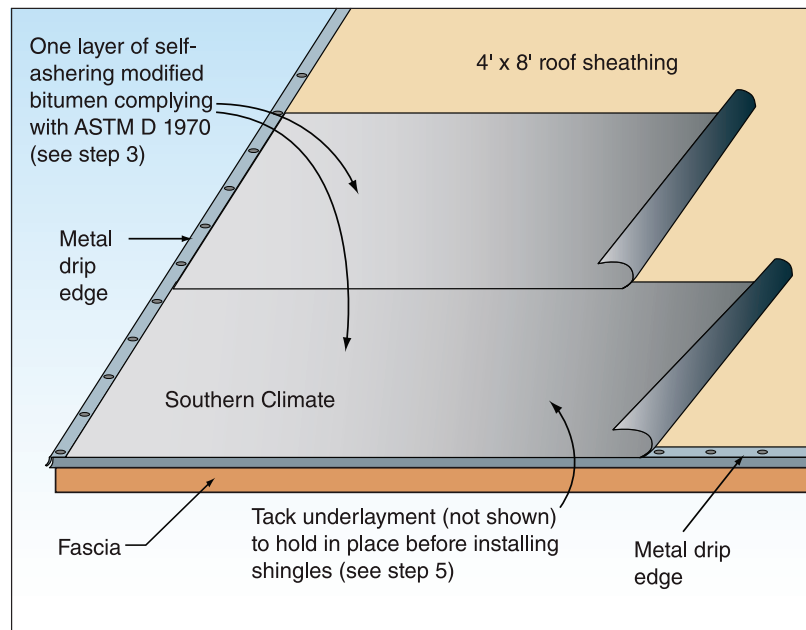
**Note:** This fact sheet provides general guidelines and recommended enhancements for improving upon typical practice. It is advisable to **consult local building requirements** for type and installation of underlayment, particularly if specific enhanced underlayment practices are required locally.

## Sheathing Installation Options

The following three options are listed in order of decreasing resistance to long-term weather exposure following the loss of the roof covering. Option 1 provides the greatest reliability for long-term exposure; it is advocated in heavily populated areas where the design wind speed is equal to or greater than 120 mph (3-second peak gust).<sup>1</sup> Option 3 provides limited protection and is advocated only in areas with a modest population density and a design wind speed less than or equal to 110 mph (3-second peak gust).<sup>1</sup>

## Installation Sequence – Option 1<sup>2</sup> (for moderate climates)

1. Before the roof covering is installed, have the deck inspected to verify that it is nailed as specified on the drawings.
2. Broom clean deck before installing self-adhering modified bitumen products. If the sheathing is OSB, check with the OSB manufacturer to determine if a primer needs to be applied before installing these products.
3. **In Southern Climates, apply a single layer of self-adhering modified bitumen complying with ASTM D 1970 throughout the roof area.**
4. Seal the self-adhering sheet to the deck penetrations with roof tape or asphalt roof cement.



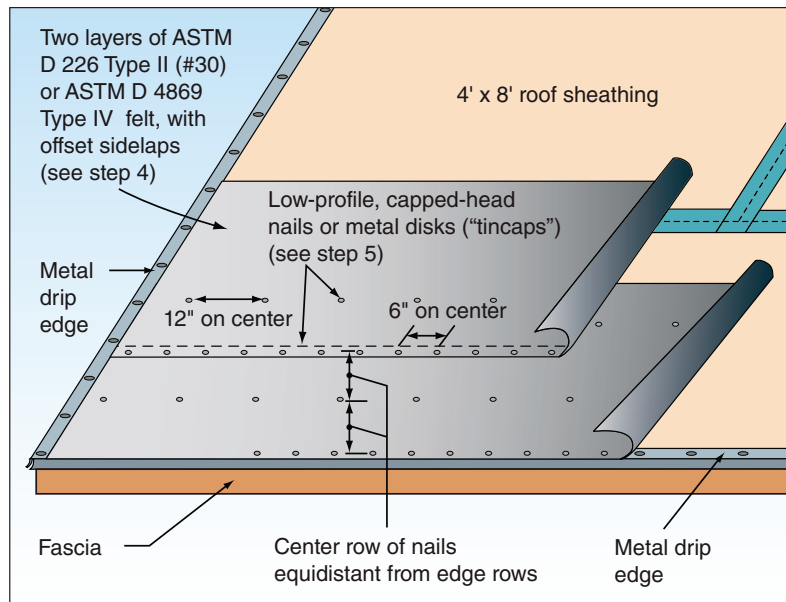
<sup>1</sup> The 110 and 120 mph speeds are based on ASCE 7-05. If ASCE 7-10 is being used, the equivalent wind speeds are 139 and 152 mph for Risk Category II buildings.



5. **Apply a single layer of ASTM D 226 Type I (#15) or ASTM D 4869 Type II felt.** Tack underlayment to hold in place before installing shingles.
6. **In northern climates**, after step 2, install self-adhering modified bitumen tape (4 inches wide, minimum) over sheathing joints; seal around deck penetrations with roof tape. Roll tape with roller.
7. **Apply a single layer of ASTM D 226 Type II (#30) or ASTM D 4869 Type IV felt. Attach per steps 8 and 9. Then install a single layer of self-adhering modified bitumen per steps 3 and 4, followed by installation of the shingles.**
8. Secure felt with low-profile, capped-head nails or thin metal disks (“tincaps”) attached with roofing nails.
9. Fasten at approximately 6 inches on center along the laps and at approximately 12 inches on center along two rows in the field of the sheet between the side laps.

### Installation Sequence – Option 2<sup>2</sup>

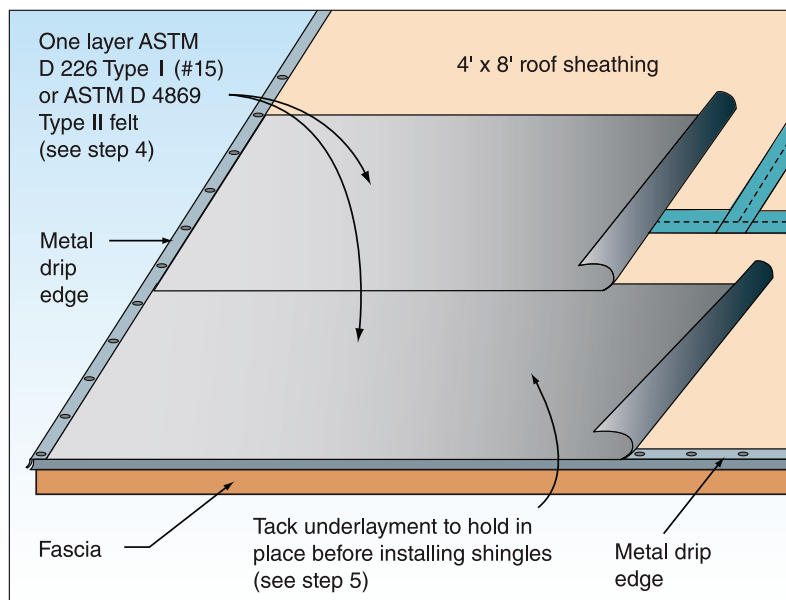
1. Before the roof covering is installed, have the deck inspected to verify that it is nailed as specified on the drawings.
2. Broom clean deck before taping. If the sheathing is OSB, check with the OSB manufacturer to determine if a primer needs to be applied before installing self-adhering modified bitumen products.
3. Install self-adhering modified bitumen tape (4 inches wide, minimum) over sheathing joints; seal around deck penetrations with roof tape. Roll tape with roller.
4. **Apply two layers of ASTM D 226 Type II (#30) or ASTM D 4869 Type IV felt with offset side laps.**



5. Secure felt with low-profile, capped-head nails or thin metal disks (“tincaps”) attached with roofing nails.
6. Fasten at approximately 6 inches on center along the laps and at approximately 12 inches on center along a row in the field of the sheet between the side laps.

### Installation Sequence – Option 3<sup>2,3</sup>

1. Before the roof covering is installed, have the deck inspected to verify that it is nailed as specified on the drawings.
2. Broom clean deck before taping. If the sheathing is OSB, check with the
- 2 If the building is within 3,000 feet of saltwater, stainless steel or hot-dip galvanized fasteners are recommended for the underlayment attachment.
- 3 (1) If the roof slope is less than 4:12, tape and seal the deck at penetrations and follow the recommendations given in The NRCA Roofing and Waterproofing Manual, by the National Roofing Contractors Association. (2) With this option, the underlayment has limited blow-off resistance. Water infiltration resistance is provided by the taped and sealed sheathing panels. This option is intended for use where temporary or permanent repairs are likely to be made within several days after the roof covering is blown off.



OSB manufacturer to determine if a primer needs to be applied before installing self-adhering modified bitumen products.

3. Install self-adhering modified bitumen tape (4 inches wide, minimum) over sheathing joints; seal around deck penetrations with roof tape. Roll tape with roller.
4. **Apply a single layer of ASTM D 226 Type I (#15) or ASTM D 4869 Type II felt.**
5. Tack underlayment to hold in place before applying shingles.

## General Notes

- Weave underlayment across valleys.
- Double-lap underlayment across ridges (unless there is a continuous ridge vent).
- Lap underlayment with minimum 6-inch leg “turned up” at wall intersections; lap wall weather barrier over turned-up roof underlayment.

## Additional Resources

National Roofing Contractors Association (NRCA). The NRCA Roofing and Waterproofing Manual. ([www.NRCA.net](http://www.NRCA.net))

ASTM Standard D6135, 2005, “Standard Practice for Application of Self-Adhering Modified Bituminous Waterproofing,” ASTM International, West Conshohocken, PA, 2005, 10.1520/D6135-05, [www.astm.org](http://www.astm.org).

*Developed in association with the National Association of Home Builders Research Center*







# Asphalt Shingle Roofing for High Wind Regions

**Purpose:** To recommend practices for installing asphalt roof shingles that will enhance wind resistance in high-wind, coastal regions.

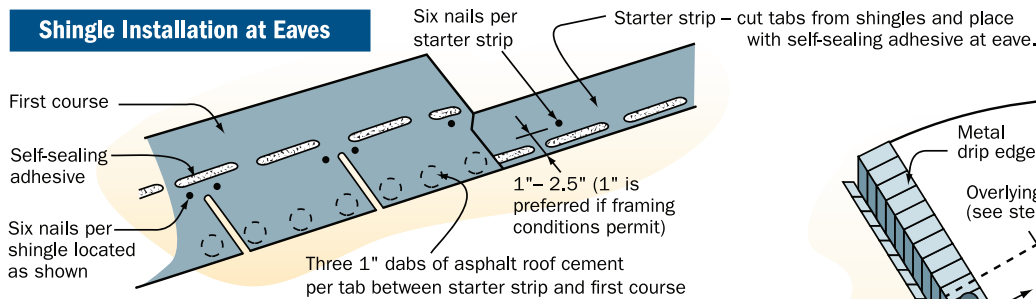
## Key Issues

- Special installation methods are recommended for asphalt roof shingles used in high-wind, coastal regions (i.e., greater than 90-mph gust design wind speed).
- Use wind-resistance ratings to choose among shingles, but do not rely on ratings for performance.
- Consult local building code for specific installation requirements. Requirements may vary locally.
- Always use underlayment. See Fact Sheet No. 7.2 for installation techniques in coastal areas.
- Pay close attention to roof-to-wall flashing and use enhanced flashing techniques (see Fact Sheet No. 5.2).

## Construction Guidance

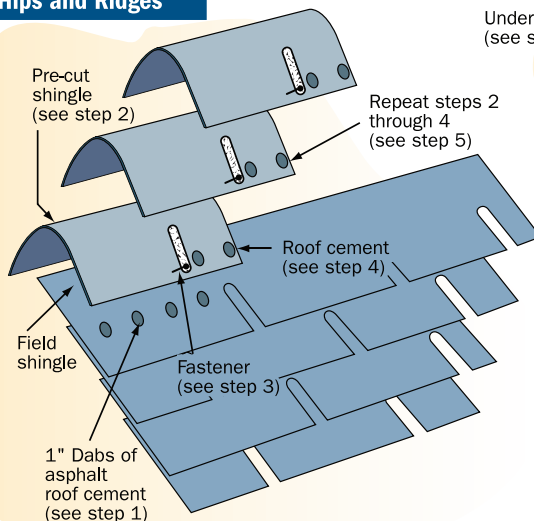
1. Follow shingle installation procedures for enhanced wind resistance.

### Shingle Installation at Eaves

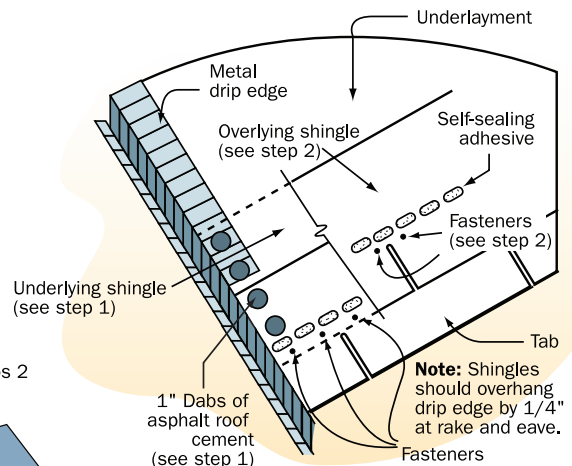


### Shingle Installation at Hips and Ridges

1. Apply four 1-inch dabs of roof cement to field shingle.
2. **Set pre-cut shingle in place and press down in dabs of roof cement before installing fasteners.**
3. Install fastener on each side of ridge. **Note:** Because of extra thickness of shingles at hips and ridges, longer nails may be needed.
4. Apply two 1-inch dabs of roof cement to shingle where shown.
5. Repeat steps 2 through 4.



Enhanced shingle securement



### Shingle Installation at Rakes

1. Apply two 1-inch dabs of asphalt roof cement on underlying shingle, and two 1-inch dabs on metal drip edge as shown.
2. Set overlying shingle in place and install fasteners except for last fastener at rake.
3. **Press shingle down to set in dabs of asphalt cement before installing final fastener.**
4. Install final fastener at rake edge.
5. Repeat steps for each course.



2. Consider shingle physical properties.

Properties	Design Wind Speed <sup>1</sup> >90 to 120 mph	Design Wind Speed <sup>1</sup> >120 mph
Fastener Pull-Through <sup>2</sup> Resistance	Minimum Recommended 25 lb at 73 degrees Fahrenheit (F)	Minimum Recommended 30 lb

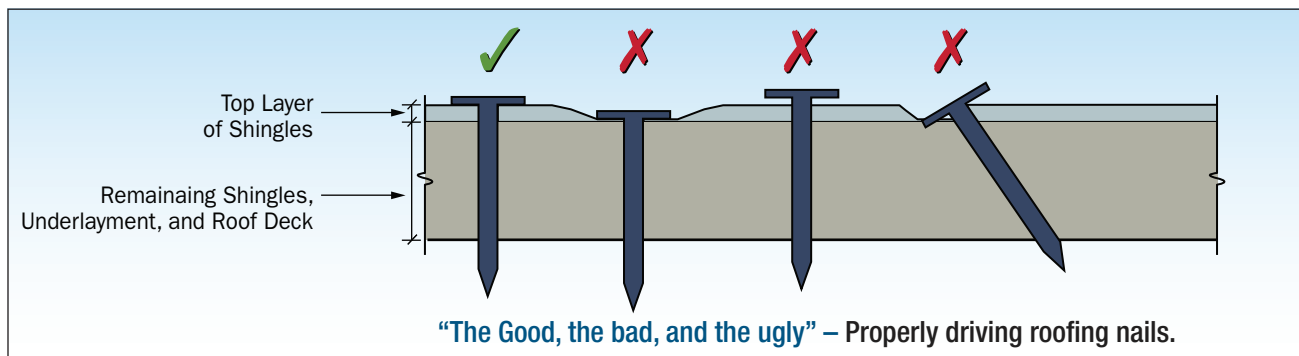
1. Design wind speed based on 3-second peak gust.
2. ASTM D 3462 specifies a minimum fastener pull-through resistance of 20 lb at 73° F. If a higher resistance is desired, it must be specified.

3. Ensure that the fastening equipment and method results in properly driven roofing nails for maximum blow-off resistance. The minimum required bond strength must be specified (see **Wind-Resistance Ratings**, below).

Shingle Type	Standard	Characteristics
Organic-Reinforced	ASTM D 225	Relatively high fastener pull-through resistance
Fiberglass-Reinforced	ASTM D 3462	Considerable variation in fastener pull-through resistance offered by different product
SBS Modified Bitumen	A standard does not exist for this product. It is recommended that SBS Modified Bitumen Shingles meet the physical properties specified in ASTM 3462.	Because of the flexibility imparted by the SBS polymers, this type of shingle is less likely to tear if the tabs are lifted in a windstorm.

### Fastener Guidelines

- Use roofing nails that extend through the underside of the roof sheathing, or a minimum of 3/4 inch into planking.
- Use roofing nails instead of staples.
- Use stainless steel nails when building within 3,000 feet of saltwater.



### Weathering and Durability

Durability ratings are relative and are not standardized among manufacturers. However, selecting a shingle with a longer warranty (e.g., 30-year instead of 20-year) should provide greater durability in coastal climates and elsewhere.

Organic-reinforced shingles are generally more resistant to tab tear-off but tend to degrade faster in warm climates. Use fiberglass-reinforced shingles in warm coastal climates and consider organic shingles only in cool coastal climates. Modified bitumen shingles may also be considered for improved tear-off resistance of tabs. Organic-reinforced shingles have limited fire resistance – verify compliance with code and avoid using in areas prone to wildfires.

After the shingles have been exposed to sufficient sunshine to activate the sealant, inspect roofing to ensure that the tabs have sealed. Also, shingles should be of “interlocking” type if seal strips are not present.

## Wind-Resistance Ratings

Wind resistance determined by test methods ASTM D 3161 and UL 997 does not provide adequate information regarding the wind performance of shingles, even when shingles are tested at the highest fan speed prescribed in the standard. Rather than rely

on D 3161 or UL 997 test data, wind resistance of shingles should be determined in accordance with UL 2390. Shingles that have been evaluated in accordance with UL 2390 have a Class D (90 mph), G (120 mph), or H (150 mph) rating. Select shingles that have a class rating equal to or greater than the basic wind speed specified in the building code. If the building is sited in Exposure D, or is greater than 60 feet tall, or is a Category III or IV, or is sited on an abrupt change in topography (such as an isolated hill, ridge, or escarpment), consult the shingle manufacturer. (Note: for definitions of Exposure D and Category III and IV, refer to ASCE 7.)

*Developed in association with the National Association of Home Builders Research Center*





# Tile Roofing for High Wind Regions

**Purpose:** *To provide recommended practices for designing and installing extruded concrete and clay tiles that will enhance wind resistance in high-wind areas.*

## Key Issues

**Missiles:** Tile roofs are very vulnerable to breakage from windborne debris (missiles). Even when well attached, they can be easily broken by missiles. If a tile is broken, debris from a single tile can impact other tiles on the roof, which can lead to a progressive cascading failure. In addition, tile missiles can be blown a considerable distance, and a substantial number have sufficient energy to penetrate shutters and glazing, and potentially cause injury. In hurricane-prone regions where the basic wind speed is equal to or greater than 110 mph (3-second peak gust), the windborne debris issue is of greater concern than in lower-wind-speed regions. Note: There are currently no testing standards requiring roof tile systems to be debris impact resistant.

**Attachment methods:** Storm damage investigations have revealed performance problems with mortar-set, mechanical (screws or nails and supplementary clips when necessary), and foam-adhesive (adhesive-set) attachment methods. In many instances, the damage was due to poor installation. Investigations revealed that the mortar-set attachment method is typically much more susceptible to damage than are the other attachment methods. Therefore, in lieu of mortar-set, the mechanical or foam-adhesive attachment methods in accordance with this fact sheet are recommended.

To ensure high-quality installation, licensed contractors should be retained. This will help ensure proper permits are filed and local building code requirements are met. For foam-adhesive systems, it is highly recommended that installers be trained and certified by the foam manufacturer.

**Uplift loads and resistance:** Calculate uplift loads and resistance in accordance with the Design and Construction Guidance section below. Load and resistance calculations should be performed by a qualified person (i.e., someone who is familiar with the calculation procedures and code requirements).

**Corner and perimeter enhancements:** Uplift loads are greatest in corners, followed by the perimeter, and then the field of the roof (see Figure 1 on page 2).



However, for simplicity of application on smaller roof areas (e.g., most residences and smaller commercial buildings), use the attachment designed for the corner area throughout the entire roof area.

**Hips and ridges:** Storm damage investigations have revealed that hip and ridge tiles attached with mortar are very susceptible to blow-off. Refer to the attachment guidance below for improved attachment methodology.

**Quality control:** During roof installation, installers should implement a quality control program in accordance with the Quality Control section on page 3 of this fact sheet.

### Classification of Buildings

- Category I** Buildings that represent a low hazard to human life in the event of a failure
- Category II** All other buildings not in Categories I, III, and IV
- Category III** Buildings that represent a substantial hazard to human life
- Category IV** Essential facilities



## Design and Construction Guidance

### 1. Uplift Loads

In Florida, calculate loads and pressures on tiles in accordance with the current edition of the Florida Building Code (Section 1606.3.3). In other states, calculate loads in accordance with the current edition of the International Building Code (Section 1609.7.3).

As an alternative to calculating loads, design uplift pressures for the corner zones of Category II buildings are provided in tabular form in the Addendum to the Third Edition of the *Concrete and Clay Roof Tile Installation Manual* (see Tables 6, 6A, 7, and 7A).<sup>1</sup>

**Note:** In addition to the tables referenced above, the *Concrete and Clay Roof Tile Installation Manual* contains other useful information pertaining to tile roofs. Accordingly, it is recommended that designers and installers of tile obtain a copy of the Manual and its Addendum. Hence, the tables are not incorporated in this fact sheet.

### 2. Uplift Resistance

For mechanical attachment, the *Concrete and Clay Roof Tile Installation Manual* provides uplift resistance data for different types and numbers of fasteners and different deck thicknesses. For foam-adhesive-set systems, the Manual refers to the foam-adhesive manufacturers for uplift resistance data. Further, to improve performance where the basic wind speed is equal to or greater than 110 mph, it is recommended that a clip be installed on each tile in the first row of tiles at the eave for both mechanically attached and foam-adhesive systems.

For tiles mechanically attached to battens, it is recommended that the tile fasteners be of sufficient length to penetrate the underside of the sheathing by  $\frac{1}{4}$  inch minimum. For tiles mechanically attached to counter battens, it is recommended that the tile fasteners be of sufficient length to penetrate the underside of the horizontal counter battens by  $\frac{1}{4}$  inch minimum. It is recommended that the batten-to-batten connections be engineered.

For roofs within 3,000 feet of the ocean, straps, fasteners, and clips should be fabricated from stainless steel to ensure durability from the corrosive effects of salt spray.

1. You can order the *Concrete and Clay Roof Tile Installation Manual* online at the website of the Florida Roofing, Sheet Metal and Air Conditioning Contractor's Association, Inc., ([www.floridarooft.com](http://www.floridarooft.com)) or by calling (407) 671-3772. Holders of the Third Edition of the Manual who do not have a copy of the Addendum can download it from the website.

### 3. Hips and Ridges

The *Concrete and Clay Roof Tile Installation Manual* gives guidance on two attachment methods for hip and ridge tiles: mortar-set or attachment to a ridge board. On the basis of post-disaster field investigations, use of a ridge board is recommended. For attachment of the board, refer to Table 21 in the Addendum to the *Concrete and Clay Roof Tile Installation Manual*.

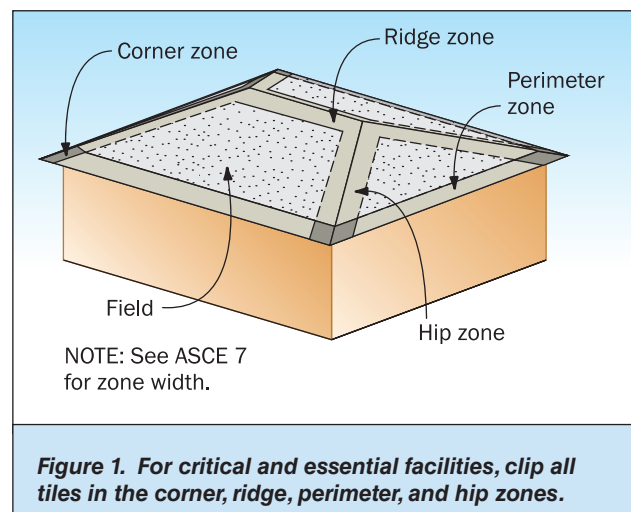
Fasten the tiles to the ridge board with screws (1-inch minimum penetration into the ridge board) and use both adhesive and clips at the overlaps.

For roofs within 3,000 feet of the ocean, straps, fasteners, and clips should be fabricated from stainless steel to ensure durability from the corrosive effects of salt spray.

### 4. Critical and Essential Buildings (Category III or IV)

Critical and essential buildings are buildings that are expected to remain operational during a severe wind event such as a hurricane. It is possible that people may be arriving or departing from the critical or essential facility during a hurricane. If a missile strikes a tile roof when people are outside the building, those people may be struck by tile debris dislodged by the missile strike. Tile debris may also damage the facility. It is for these reasons that tiles are not recommended on critical or essential buildings in hurricane-prone regions (see ASCE 7 for the definition of hurricane-prone regions).

If it is decided to use tile on a critical or essential facility and the tiles are mechanically attached, it is recommended that clips be installed at all tiles in the corner, ridge, perimeter, and hip zones (see ASCE 7 for the width of these zones). (See Figure 1.)



**Figure 1. For critical and essential facilities, clip all tiles in the corner, ridge, perimeter, and hip zones.**

## 5. Quality Control

It is recommended that the applicator designate an individual to perform quality control (QC) inspections. That person should be on the roof during the tile installation process (the QC person could be a working member of the crew). The QC person should understand the attachment requirements for the system being installed (e.g., the type and number of fasteners per tile for mechanically attached systems and the size and location of the adhesive for foam-adhesive systems) and have authority to correct noncompliant work. The QC person should ensure that the correct type, size, and quantity of fasteners are being installed.

For foam-adhesive systems, the QC person should ensure that the foam is being applied by properly trained applicators and that the work is in accordance with the foam manufacturer's application instructions. At least one tile per square (100 square feet) should be pulled up to confirm the foam provides the minimum required contact area and is correctly located.

If tile is installed on a critical or essential building in a hurricane-prone region, it is recommended that the owner retain a qualified architect, engineer, or roof consultant to provide full-time field observations during application.

*Developed in association with the National Association of Home Builders Research Center*







# Minimizing Water Intrusion Through Roof Vents in High-Wind Regions

**Purpose:** *To describe practices for minimizing water intrusion through roof vent systems that can lead to interior damage and mold growth in high-wind regions (i.e., greater than 90-miles per hour [mph] basic [gust design] wind speed).*<sup>1</sup>

## Key Issues

- Hurricane winds can drive large amounts of water through attic ventilation openings. The accumulating water soaks insulation and gypsum board, which can lead to mold growth and, in some cases, to the collapse of ceilings.
- Attic ventilation can be provided by a number of devices, most of which have been observed to allow water intrusion under certain conditions and some of which have been observed to blow off. These devices include:
  - Soffit vents
  - Ridge vents
  - Gable end vents
  - Off-ridge vents
  - Gable rake vents
  - Turbines
- Adequate ventilation of attics is generally required to promote the health of wood structural members and sheathing in the attic.
- Attic ventilation can reduce the temperatures of roof coverings, which will typically prolong the life of the roof covering. However, roof color can have more of an impact on roof covering temperature than the amount of ventilation that is or is not provided.
- An unvented attic can be an effective way to prevent water intrusion and this type of attic is gaining popularity for energy efficiency reasons, provided the air conditioning system is sized appropriately. However, an unvented attic is best accomplished when it is specifically designed into the house and all of the appropriate details are handled properly. On an existing house, any

### The Unvented Attic

The most conservative approach to preventing wind-driven rain from entering the attic is to eliminate attic ventilation, but unvented attics are controversial. Although allowed by the International Residential Code (IRC), provided the Code's criteria are met, unvented attics may not comply with local building codes.

However, when unvented attics are allowed by the building code or code compliance is not an issue, and when climatic and interior humidity conditions (e.g., no indoor swimming pools) are conducive to an unvented design, an unvented attic is a reliable way to prevent wind-driven rain from entering the attic.

**Air barrier:** Refer to Fact Sheet 5.3, *Siding Installations in High-Wind Regions* for recommendations regarding attic air barriers.

attempt to change to an unvented attic configuration needs to be done very carefully with the advice of knowledgeable experts. There are a number of changes that have to be made to produce a successful transition from a ventilated to an unvented attic. One side effect of going to an unvented attic may be to void the warranty for the roof covering.

The following information is intended to help minimize water intrusion through new and existing attic ventilation systems, not to change from a ventilated to an unvented system. With the exception of the plugging of gable rake vents, all other shuttering of openings or plugging of vents should be done on a temporary basis and removed once the storm threat is over so that the attic is once again properly ventilated.

<sup>1</sup> The 90 mph speed is based on ASCE 7-05. If ASCE 7-10 is being used, the equivalent wind speed is 116 mph for Risk Category II buildings



## Mitigation Guidance

### Soffit Vents

#### Key Issues

- It is important to keep the soffit material in place. While some water can be blown into the attic through almost any type of soffit vent, the amount of water intrusion increases dramatically when the soffit material is missing (Figure 1).
- Plywood or wood soffits are generally adequately anchored to wood framing attached to the roof structure and/or the walls. However, it has been common practice for vinyl and aluminum soffit panels to be installed in tracks that are frequently very poorly connected to the walls and fascia at the edge of the roof overhang. When these poorly anchored soffits are blown off, water intrusion increases significantly. Properly installed vinyl and aluminum soffit panels are fastened to the building structure or to nailing strips placed at intervals specified by the manufacturer.



Figure 1. Missing soffit material.

#### Proper Installation

The details of proper installation of vinyl and aluminum soffits depend on the type of eave to which they are attached. The key elements are illustrated in Figure 2.

- Roof truss or rafter framing should extend across the bottom of the eaves, or be added to create a structural support for the soffit. As an alternative, soffits can be attached directly to the undersides of the angled rafters.
- Nailing strips should be provided, if necessary, to allow attachment of the soffit at the ends. Intermediate nailing strips may be needed, depending on the maximum span permitted for the soffit. If this is not known, the span between attachment points should not exceed 12" in high-wind regions.
- A J-channel (illustrated), F-channel, or other receiver as specified by the manufacturer should cover the ends of the soffit panels. Fasteners should be those specified by the manufacturer. Fasteners should be used through the nailing strip of each panel and at any other points (such as in the "valleys" of the soffit) if specified.
- The overall span (eave depth) of the soffit should not exceed any limits specified by the manufacturer, and any required intermediate attachment points should be used.

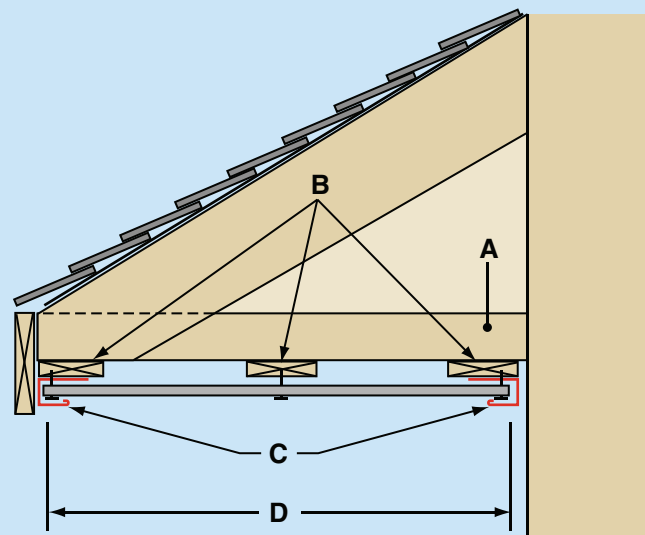


Figure 2. Key soffit installation points.

### Checking Soffit Material Installation

As previously noted, the most critical soffit installations to check are those where vinyl or aluminum soffit panels are used. Soffits should be fastened to the eave structure; they should not be loose in the channels. Pushing up on the soffit material and the channels used to support the material can be revealing. If it moves readily or is easy to deform, it probably is not attached very well. Similarly, if the width of the overhang is greater than 12 inches, there should be an intermediate support running along the middle of the soffit and the panels should be attached to this support in addition to the supports at the ends of the panels. If the reader is concerned about the installation but cannot be sure, there are a couple of tools with a viewing screen connected to a small camera lens and light mounted at the end of a flexible tube that can be used to observe the connections. These devices allow inspection through a small hole that is drilled in an inconspicuous location that can be later filled with sealant. In order to ensure that there is a strong connection at the wall, there should be wood blocking running along the wall above the track where the soffit channel is attached and the channel should be fastened to that blocking. If there is no wood blocking, and there is either no vertical nailing surface on the channel or occasional tabs that have been cut and bent up to allow fastening to the wall, strengthening of the anchorage of the soffit material is clearly indicated.

### Remedial Measures

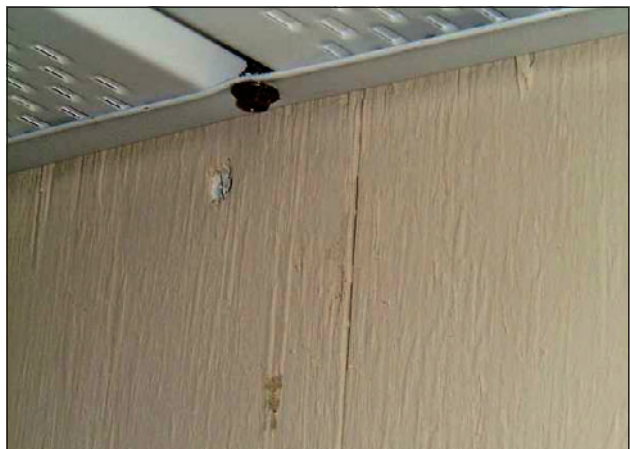
If the inspection indicates a poorly attached soffit, the best way to ensure that the soffit material is adequately anchored in place is to remove it and install adequate wood blocking to allow solid anchorage of the soffit material. In some cases, it may be possible to remove the soffit material and reinstall it. However, it is also likely that some or all of the material will need to be replaced, so make sure that it can be matched before it is removed. Short of removing and properly reinstalling the soffit material, testing has shown that the anchorage can be greatly improved by applying a bead of sealant (Figure 3) along the bottom edge of the wall channel to adhere it to the wall surface below followed by applying large dabs of sealant in indentations between the soffit panels and the wall channel at one end (Figure 4) and the fascia flashing at the other end. Surfaces receiving sealant should be cleaned in order to facilitate bonding. Extra resistance can be gained by installing screws that mechanically tie the soffit panels to both the fascia flashing and to the wall channel (Figure 5). Note that use of sealant is a remedial measure only and is not a substitute for proper installation and fastening of soffits in a new installation.



**Figure 3. Applying a bead of sealant. (Note: Black sealant was used so that it would be visible in the photograph. Normally a matching sealant color would be used.)**



**Figure 4. Applying dabs of sealant.**



**Figure 5. Screws through wall channel.**

**Wind-driven rain penetration:** Currently there is no adequate standard test method to evaluate the potential for wind-driven rain to enter attics through soffit vent openings, such as those shown in Figure 6. To avoid water entry at soffit vents, options include eliminating soffit vents and providing an alternate method for air to enter the attic, or design for an unvented attic. Another approach is to place filter fabric (like that used for heating, ventilation, or cooling [HVAC] system filters) above the vent openings; however, such an approach needs to be custom designed.



**Figure 6. Fiber cement soffit with ventilation slots (red arrow).**

**Fascia cover:** Field investigations after Hurricane Ike showed many cases where the aluminum fascia cover (fascia cap) from the fascia board was blown off (Figure 7). The fascia cover normally covers the ends of vinyl and aluminum soffits. When the fascia cover is blown off, the ends of the soffit panels are exposed to wind and wind-driven rain.

**Rain screen wall venting:** In lieu of providing soffit vents, another method to provide attic air intake is through a pressure-equalized rain screen wall system as discussed in *Siding Installation in High-Wind Regions*, Hurricane Ike Recovery Advisory. This alternative approach eliminates soffit vents and their susceptibility to wind-driven rain entry.



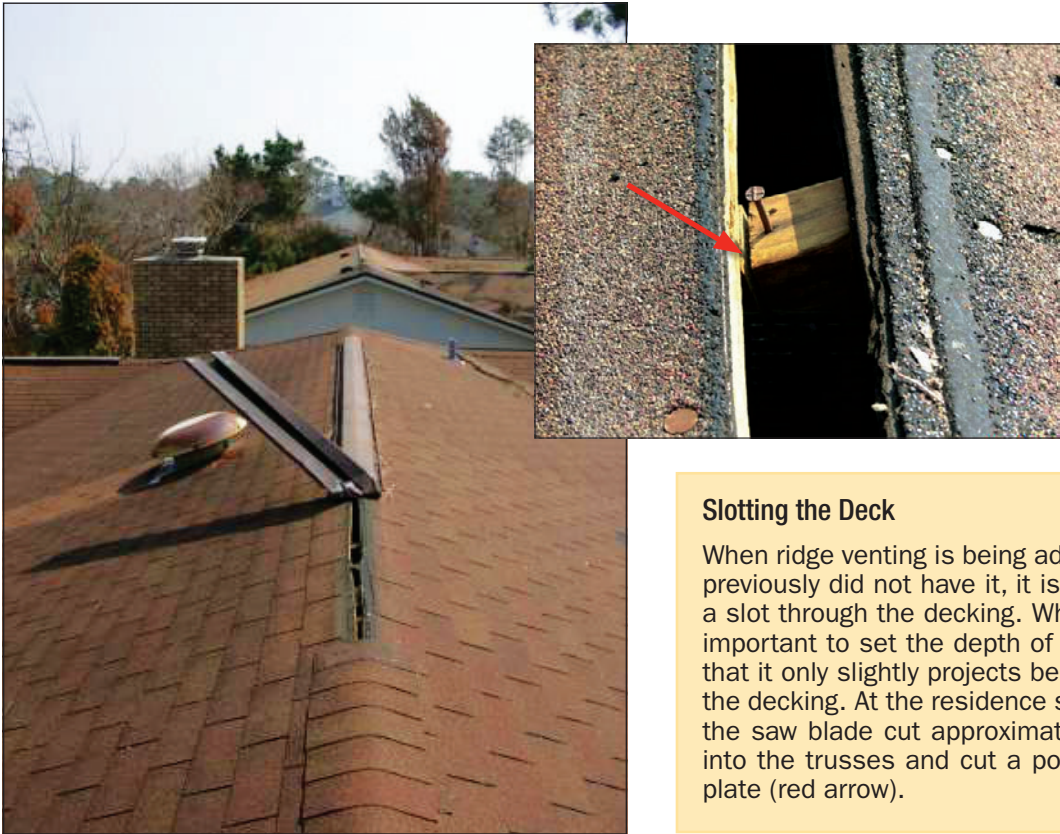
**Figure 7. Loss of fascia cover exposes ends of vinyl soffit to direct entry of wind-driven rain.**

The IRC currently has no guidelines for the installation of fascia covers. Aluminum fascia covers are typically tucked under the roof drip edge and face-nailed every few feet. More frequent nailing would help secure the fascia cover, but would also inhibit normal thermal movement, which can cause unattractive warping and dimpling of the cover. Vinyl fascia covers are available, which are attached to a continuous strip of utility trim placed underneath the drip edge. This provides a somewhat more secure, continuous attachment and allows for thermal movement. Aluminum fascia covers can also be field notched and installed with utility trim.

## Ridge Vents

### Key Issues

- Ridge vents are frequently fastened down using ordinary roofing nails since these are normally handy. It is fairly common to find ridge vents dislodged or blown off during a hurricane (Figure 8). Even a partially dislodged ridge vent can begin to act like a scoop that collects wind-driven rain and directs it into the attic.
- Most roofing manufacturers now make ridge vents that have passed wind-driven water tests. They are identified as having passed Florida Building Code's Product Approvals or Testing Application Standard (TAS) 100(A). Typically, they include a baffle in front of the vent tubes that provide the passageway for hot attic gases to escape. This baffle is intended to trip any flow of wind and water blowing up the surface of the roof and deflect it over the top of the roof ridge.



**Figure 8.** This metal ridge vent was attached with widely spaced roofing nails.

**Slotting the Deck**

When ridge venting is being added to a roof that previously did not have it, it is necessary to cut a slot through the decking. When doing so, it is important to set the depth of the saw blade so that it only slightly projects below the bottom of the decking. At the residence shown in Figure 8, the saw blade cut approximately 1 1/2 inches into the trusses and cut a portion of the truss plate (red arrow).

**Checking Ridge Vents and Their Installation**

When they are used, ridge vents are the last part of the roof to be installed. Consequently, the connection is readily accessible and frequently visible without having to pry up the edge of the vent cover top. Check the type and condition of the fasteners. If the fasteners are nails, replacement of the fasteners is in order. If the vent has clear holes or slots without any baffle or trip next to the edge of the vent channels, the vent is probably not one that is resistant to water intrusion and you should consider replacing the ridge vent with one that has passed the wind-driven water intrusion tests.

**Remedial Measures**

Replace nails with gasketed stainless steel wood screws that are slightly larger than the existing nails and, if possible, try to add fasteners at locations where they will be embedded in the roof structure below and not just into the roof sheathing. Close spacing of fasteners is recommended (e.g., in the range of 3 to 6 inches on center, commensurate with the design wind loads). If the ridge vents are damaged or are one of the older types that are not resistant to water intrusion, they should be replaced with vents that have passed the wind-driven water intrusion tests.



**Figure 9.** Gable end vent.

**Gable End Vents**

**Key Issues**

- Virtually all known gable end vents (Figure 9) will leak when the wall they are mounted on faces into the wind-driven rain. The pressures developed between the outside surface of the wall and the inside of the attic are sufficient to drive water uphill for a number of inches and, if there is much wind flow through the vent, water carried by the wind will be blown considerable distances into the attic.

## Remedial Measures

If it is practical and possible to shutter gable end vents from the outside of the house, this is the preferable way to minimize water intrusion through gable end vents (Figure 10). Install permanent anchors in the wood structure around the gable vent and pre-cut, pre-drill, and label plywood or other suitable shutter materials so that they are ready for installation by a qualified person just before a storm approaches. If installation of shutters from the outside is difficult because of the height or other considerations, but there is access through the attic, the gable vent opening can be shuttered from the inside. However, careful attention needs to be paid to sealing around the shutter and making sure that any water that accumulates in the cavity can drain to the outside of the house and not into the wall below.



**Figure 10. Shuttered gable end vent.**

## Off-ridge Vents

### Key Issues

Poorly anchored off-ridge vents can flip up and become scoops that direct large amounts of wind-driven rain into the attic (Figure 11).

Some vents are also prone to leaking when winds blow from certain directions. This will depend on the location of the vent on the roof surface and the geometry of the roof, as well as the geometry of the particular vent.

### Checking Off-Ridge Vent Installations

Off-ridge vents typically have a flange that lies against the top surface of the roof sheathing and is used to anchor the vent to the roof sheathing. Frequently, roofing nails are used to attach the flange to the roof sheathing. The off-ridge vents should be checked to make sure that they are well anchored to the roof sheathing. If they seem loose, or there are not many fasteners holding them down, it could be a weak link



**Figure 11. Two off-ridge vents are shown in this photograph. The vent that is covered with roofing felt flipped up and allowed a substantial amount of water to enter the residence. Carpeting, kitchen cabinets, and a large amount of gypsum board had to be replaced because of the water intrusion.**

in preventing water intrusion when a storm occurs. Since the flange and fasteners are hidden below the roof covering, it is not possible to simply add nails or screws to improve the anchorage as these will create holes through the roof covering.

## Remedial Measures

If the off-ridge vent is attached to the roof sheathing with long, thin nails, it may be possible to improve the anchorage by cinching the nails (bending them over against the underside of the roof sheathing). However, if they are short and/or thick, trying to bend them over may cause more harm than good. Some homeowners have had covers made that can be installed from the inside of the attic over the hole where the off-ridge vent is installed. This will be easiest if the vent is larger than the hole and the cover can be attached to the sheathing in an area where the fasteners cannot be driven through the roof covering. Otherwise, it will be important to ensure that the fasteners are short enough that they will not extend through the roof sheathing and damage the roof cover. If the edge of the hole in the roof deck is flush with the inside edge of the vent, it may be possible to install metal straps that are screwed into the walls of the vent and attached with short screws to the bottom surface of the roof sheathing. Again, it is critical to use screws that are short enough that they will not extend through the roof sheathing and damage the roof covering. The strapping should be connected to the walls of the vent with short stainless steel sheet metal screws.

## Gable Rake Vents

### Key Issues

- Gable rake vents are formed when porous soffit panels or screen vents are installed on the bottom surface of the roof overhang at the gable end and there is a clear path for wind to blow into the attic. This usually happens when the gable overhang is supported by what are called outriggers. Outriggers are typically used when gable overhangs exceed 12 inches. In these cases, the last roof truss or rafter (the gable end truss or rafter) is smaller than the trusses or rafters at the next location inside the attic. Outriggers (2x4s) are installed over top of the last gable truss or rafter, one end is anchored to the second truss or rafter back from the gable end, and the other end sticks out past the gable end wall to support the roof sheathing on the overhang.

### Finding Out if You Have Gable Rake Vents and Whether You Still Need Them

The easiest way to tell if the roof has gable rake vents is to look in the attic on a cool sunny day and see if light is visible in gaps just below the sheathing at the gable end. The presence of the outriggers (2x4s running perpendicular to the gable truss and disappearing into the gable overhang) should also be visible. If there is also a gable end vent or a ridge vent, then the gable rake vent will probably not be needed in order to provide adequate venting for the attic.

### Remedial Measures

The best solution if venting provided by the gable rake vents is not needed is to simply plug them up with metal flashing (Figure 12) or pieces of wood that are cut and anchored. They should be well attached and completely seal as many of the openings as possible



**Figure 12.** Metal plugs (red arrows) in gable rake vents.

and particularly those near the gable peak. Sealant can be used to seal around the edges of the metal or wood plugs.

## Turbines

### Key Issues

- The rotating top portion of many turbines is not designed to withstand high-wind conditions and they are frequently installed with just a friction fit to the short standpipe that provides the venting of the attic. It is possible to find high-wind rated turbines on store shelves in hurricane-prone regions but, in hurricane winds, the turbines will be rotating at tremendous speeds and can be easily damaged by windborne debris.
- The flange on the standpipe that provides the connection of the pipe to the roof sheathing may also be poorly anchored to the roof sheathing.

### Checking Turbines and Their Installation

Check any turbines to make sure that the stand pipes are not loose and that the turbine head is anchored to the stand pipe by sheet metal screws and not simply by a friction fit (Figure 13).



**Figure 13.** This turbine head is attached to the standpipe with dimple punches. Sheet metal screws should be added to strengthen the connection.

### Remedial Measures

Loose standpipes should be securely anchored to the roof sheathing. If the standpipe is attached to the roof sheathing with long, thin nails, it may be possible to improve the anchorage by cinching the nails (bending them over against the underside of the roof sheathing). However, if they are short and/or thick, trying to bend them over may cause more harm than good. Some homeowners have had covers made that can be installed from the inside of the attic over the

hole where the standpipe is installed. This will be easiest if the standpipe is larger than the hole and the cover can be attached to the sheathing in an area where the fasteners cannot be driven through the roof cover. Otherwise, it will be important to ensure that the fasteners are short enough that they will not extend through the roof sheathing and damage the roof cover.

If the edge of the hole in the roof deck is flush with the inside edge of the standpipe, it may be possible to install metal straps that are screwed into the walls of the standpipe and attached with short screws to the bottom surface of the roof sheathing. Again, it is critical to use screws that are short enough that they will not extend through the roof sheathing and damage the roof cover. The strapping should be connected to the walls of the standpipe with short stainless steel sheet metal screws.

Beyond any remedial measures taken to anchor the standpipe to the roof sheathing or to plug the hole from the attic side, it is also important to try and seal the standpipe from the outside so that water does not build up in the pipe and leak into the roof sheathing around the hole. The best approach is to have a qualified person remove the top active portion of the turbine vent before the storm and plug the hole at the top of the standpipe. A wooden plug can be used that covers the entire hole and has blocks that rest against the walls of the standpipe where screws can be installed to anchor the plug to the standpipe. Some homeowners have had the entire turbine wrapped in plastic to keep water out during a storm (Figure 14). This can work as long as the turbine or wrapping does not get dislodged. The smaller area provided by removing the turbine top and plugging the hole is considered preferable.



**Figure 14. Plastic wrapped turbines.**



# Metal Roof Systems in High-Wind Regions

**Purpose:** To describe practices for designing and installing metal roof systems that will enhance wind resistance in high-wind regions (i.e., greater than 90 miles per hour [mph] basic [gust design] wind speed).<sup>1</sup>

## Key Issues

Damage investigations have revealed that some metal roofing systems have sufficient strength to resist extremely high winds (Figure 1), while other systems have blown off during winds that were well below design wind speeds given in ASCE 7. When metal roofing (or hip, ridge, or rake flashings) blows off during hurricanes, water may enter the building at displaced roofing; blown-off roofing can damage buildings and injure people. Here is general guidance for achieving successful wind performance:

1. Always follow the manufacturer's installation instructions and local building code requirements.
2. Calculate loads on the roof assembly in accordance with ASCE 7 or the local building code, it is recommended to use whichever procedure results in the highest loads.
3. Specify/purchase a metal roof system that has sufficient uplift resistance to meet the design uplift loads.
  - For standing seam metal panel systems, the 2009 International Building Code (IBC) requires test methods UL 580 or ASTM E 1592. For standing seam systems, it is recommended that design professionals specify E 1592 testing, because it gives a better representation of the system's uplift performance capability.
  - For safety factor determination, refer to Chapter F in standard NAS-01, published by the American Iron and Steel Institute.
  - For through-fastened steel panel systems, the IBC allows uplift resistance to be evaluated by testing or by calculations in accordance with standard NAS-01.



**Figure 1.** This structural standing seam roof system survived Hurricane Andrew (Florida, 1992), but some hip flashings were blown off. The estimated wind speed was 170 mph (peak gust, at 33 feet for Exposure C).

- For architectural panels with concealed clips, test method UL 580 is commonly used. However, it is recommended that design professionals specify ASTM E 1592 because it gives a better representation of the system's uplift performance capability. When testing architectural panel systems via ASTM E 1592, the deck joints need to be unsealed in order to allow air flow to the underside of the metal panels. Therefore, underlayment should be eliminated from the test specimen, and a 1/8 inch minimum between deck panel side and end joints should be specified.
- For safety factor determination, refer to Chapter F of the *North American Specification for the Design of Cold-Formed Steel Structural Members* (AISI S100-07).

This fact sheet addresses wind and wind-driven rain issues. For general information on other aspects of metal roof system design and construction (including seam types, metal types, and finishes), see the "Additional Resources" section.

<sup>1</sup> The 90 mph speed is based on ASCE 7-05. If ASCE 7-10 is being used, the equivalent wind speed is 116 mph for Risk Category II buildings.



- For copper roofing testing, see “NRCA analyzes and tests metal,” Professional Roofing, May 2003.
  - For metal shingles, it is recommended that uplift resistance be based on test method UL 580 or 1897.
  - Specify the design uplift loads for field, perimeter, and corners of the roof. Also specify the dimension of the width of the perimeter. (Note: For small roof areas, the corner load can be used throughout the entire roof area.)
4. Suitably design the roof system components (see the “Construction Guidance” section).
  5. Obtain the services of a professional roofing contractor to install the roof system.

## Metal Roofing Options

A variety of metal panel systems (including composite foam panels) are available for low-slope (i.e., 3:12 or less) and steep-slope (i.e., greater than 3:12) roofs. Metal shingles are also available for steep-slope roofs. Common metal roofing options are:

**Standing-Seam Hydrostatic (i.e., water-barrier) Systems:** These panel systems are designed to resist water infiltration under hydrostatic pressure. They have standing seams that raise the joint between panels above the water line. The seam is sealed with sealant tape (or sealant) in case it becomes inundated with water backed up by an ice dam or driven by high wind.

Most hydrostatic systems are structural systems (i.e., the roof panel has sufficient strength to span between purlins or nailers). A hydrostatic architectural panel (which cannot span between supports) may be specified, however, if continuous or closely spaced decking is provided.

**Hydrokinetic (i.e., water-shedding) panels:** These panel systems are not designed to resist water infiltration under hydrostatic pressure and therefore require a relatively steep slope (typically greater than 3:12) and the use of an underlayment to provide secondary protection against water that infiltrates past the panels. Most hydrokinetic panels are architectural systems, requiring continuous or closely spaced decking to provide support for gravity loads.

Some hydrokinetic panels have standing ribs and concealed clips (Figure 2), while others (such as 5V-crimp panels, R-panels [box-rib]

For observations of metal roofing performance during Hurricanes Charley (2004, Florida), Ivan (2004, Alabama and Florida), and Katrina (Alabama, Louisiana, and Mississippi, 2005), respectively; see Chapter 5 in FEMA MAT reports 488, 489, and 549.

For attachment of corrugated metal panels, see FEMA 55, *Coastal Construction Manual, Appendix K*, available online at: <http://www.fema.gov/library/viewRecord.do?id=1671>.

An advantage of exposed fastener panels (versus panels with concealed clips) is that, after installation, it is easy to verify that the correct number of fasteners was installed. If fastening was not sufficient, adding exposed fasteners is easy and economical.

and corrugated panels) are through-fastened (i.e., attached with exposed fasteners). Panels are available that simulate the appearance of tile.

**Metal Shingles:** Metal shingles are hydrokinetic products and require a relatively steep-slope and the use of an underlayment. Metal shingles are available that simulate the appearance of wood shakes and tiles.



**Figure 2.** This architectural panel system has concealed clips. The panels unclipped from the clips. The first row of clips (just above the red line) was several inches from the end of the panels. The first row of clips should have been closer to the eave.

## Construction Guidance

- Consult local building code requirements and manufacturer’s literature for specific installation requirements. Requirements may vary locally.
- Underlayment: If a robust underlayment system is installed, it can serve as a secondary water barrier if the metal roof panels or shingles are blown off (Figures 2 and 3). For enhanced underlayment recommendations, see Fact Sheet No. 7.2, *Roof Underlayment for Asphalt Shingle Roofs*. Fact Sheet 7.2 pertains to underlayment options for asphalt shingle roofs. For metal panels and tiles, where Fact Sheet 7.2 recommends a Type I (#15) felt, use a Type II (#30) felt because the heavier felt provides greater resistance to puncture by the panels during application. Also, if a self-adhering modified bitumen underlayment is used, specify/purchase a product that is intended for use underneath metal (such products are more resistant to bitumen flow under high temperature).



**Figure 3.** These architectural panel system have snap-lock seams. One side of the seam is attached with a concealed fastener. Although a large number of panels blew away, the underlayment did not.

- Where the basic (design) wind speed is 110 mph<sup>2</sup> or greater, it is recommended that not less than two clips be used along the eaves, ridges, and hips. Place the first eave clip within 2 to 3 inches of the eave, and place the second clip approximately 3 to 4 inches from the first clip. Figures 2 and 4 illustrate ramifications of clips being too far from the eave.
- For copper panel roofs in areas with a basic wind speed greater than 90 mph,<sup>3</sup> it is recommended that Type 304 or 316 stainless steel clips and stainless steel screws be used instead of more malleable copper clips.



**Figure 4.** These eave clips were too far from the panel ends. The clip at the left was 13" from the edge of the deck. The other clip was 17" from the edge. It would have been prudent to install double clips along the eave.

- When clip or panel fasteners are attached to nailers (Figures 5–7), detail the connection of the nailer to the nailer support (including the detail of where nailers are spliced over a support).



**Figure 5.** The panels blew off the upper roof and landed on the lower roof of this house. The upper asphalt shingle roof shown had been re-covered with 5V-Crimp panels that were screwed to nailers. The failure was caused by inadequate attachment of the nailers (which had widely-spaced nails) to the sheathing. Note that the hip flashing on the lower roof blew off.

- 2 The 110 mph speed is based on ASCE 7-05. If ASCE 7-10 is being used, the equivalent wind speed is 142 mph for Risk Category II buildings.
- 3 The 90 mph speed is based on ASCE 7-05. If ASCE 7-10 is being used, the equivalent wind speed is 116 mph for Risk Category II buildings.



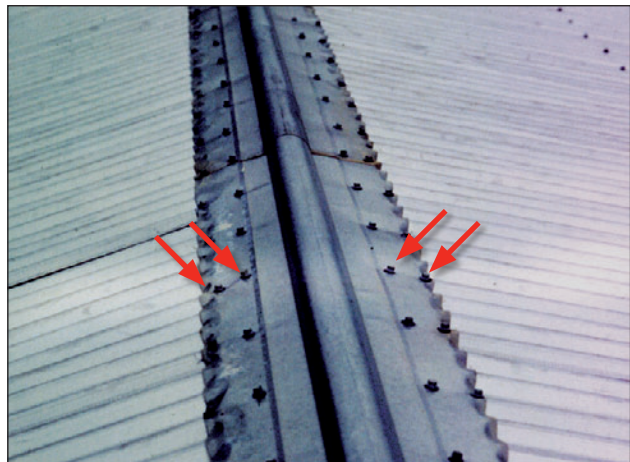
**Figure 6.** Blow-off of nailers caused these panels to progressively fail. The nailers were installed directly over the trusses. In an assembly such as this where there is no decking, there is no opportunity to incorporate an underlayment. With loss of the panels, rainwater was free to enter the building.

- When clip or panel fasteners are loaded in withdrawal (tension), screws are recommended in lieu of nails.
- For roofs located within 3,000 feet of the ocean line, 300 series stainless steel clips and fasteners are recommended.
- For concealed clips over a solid substrate, it is recommended that chalk lines be specified so that the clips are correctly spaced.
- Hip, ridge, and rake flashings: Because exposed fasteners are more reliable than cleat attachment, it is recommended that hip, ridge, and rake flashings be attached with exposed fasteners. Two rows of fasteners are recommended on either side of the hip/ridge line. Close spacing of fasteners is recommended (e.g., spacing in the range of 3 to 6 inches on center, commensurate with the design wind loads), as shown in Figure 8 in order to avoid flashing blow-off as shown in Figure 9.

**Figure 9.** The ridge flashing fasteners were placed too far apart. A significant amount of water leakage can occur when ridge flashings are blown away.



**Figure 7.** This residence had metal shingles that simulated the appearance of tile. The shingles typically blew off the battens, but some of the battens were also blown away.



**Figure 8.** The ridge flashing on these corrugated metal panels had two rows of fasteners on each side of the ridge line.



## Additional Resources

For general information on other aspects of metal roof system design and construction (including seam types, metal types, and finishes), see:

Copper and Common Sense, (<http://www.reverecopper.com>)

Copper Development Association, (<http://www.copper.org/publications>)

Metal Building Manufacturers Association, *Metal Roofing Systems Design Manual*, 2000, (<http://www.mbma.com/display.cfm?p=44&pp6&i=47>)

Metal Construction Association, (<http://www.metalconstruction.org/pubs>)

National Institute of Building Sciences, *Whole Building Design Guide*, ([http://www.wbdg.org/design/env\\_roofing.php](http://www.wbdg.org/design/env_roofing.php))

National Roofing Contractors Association, *The NRCA Roofing Manual: Metal Panel and SPF Roof Systems*, 2008, (<http://www.nrca.net/rp/technical/manual/default.aspx>)

Sheet Metal and Air Conditioning Contractors National Association, *Architectural Sheet Metal Manual*, 2003, (<http://www.smacna.org/bookstore>)

American Iron and Steel Institute, *North American Specification for the Design of Cold-Formed Steel Structural Members* (AISI S100-07), 2007, (<http://www.steel.org>)

American Iron and Steel Institute (<http://www.professionalroofing.net/article.aspx?id=266>)

FEMA MAT reports 488, 489, FEMA 543 (Section 3.4.3.4), 549, FEMA 577 (Section 4.3.3.8). (<http://www.fema.gov/library>).

International Organization of Standards (ISO), Document ISO 14021, (<http://www.iso.org>).

Professional Roofing, "NRCA analyzes and tests metal," May 2003, (<http://www.professionalroofing.net>)



# Enclosures and Breakaway Walls

**Purpose:** To discuss requirements and recommendations for enclosures and breakaway walls below the Base Flood Elevation (BFE).

## Key Issues

- Areas enclosed by solid walls below the BFE (“enclosures”) are subject to strict regulation under the National Flood Insurance Program (NFIP). Note that some local jurisdictions enforce stricter regulations for enclosures.
- Spaces below elevated buildings can be used only for building access, parking, and storage.
- Enclosures in V Zone buildings must be breakaway (non-breakaway enclosures are prohibited). Breakaway enclosures in V Zones must be built with flood-resistant materials, meet specific design requirements, and be certified by a registered design professional.
- Enclosures (breakaway and non-breakaway) in A Zone buildings must be built with flood-resistant materials and equipped with flood openings that allow water levels inside and outside to equalize.
- Breakaway enclosure walls should be considered expendable, and the building owner could incur significant costs when the walls are replaced. Breakaway wall replacement is not covered under flood insurance policies.
- For V Zones, breakaway wall enclosures below an elevated building will result in higher flood insurance premiums; however, surrounding below-BFE space with insect screening, open lattice, slats, or shutters (louvers) can result in much lower flood insurance premiums (Figure 1) and will likely reduce damage during less-than-base-flood events. It is also recommended that breakaway walls be designed to break into smaller sections so that they're less likely to damage the foundation or the upper portions of buildings.



Figure 1. Wood louvers installed beneath an elevated house in a V Zone are a good alternative to solid breakaway walls.



### WARNING

Designers, builders, and homeowners should realize that: (1) enclosures and items within them are likely to be destroyed even during minor flood events; (2) enclosures, and most items within them, are not covered under flood insurance, which can result in significant costs to the building owner; and (3) even the presence of properly constructed breakaway wall enclosures will increase flood insurance premiums for the entire building (the premium rate will increase as the enclosed area increases). Including enclosures in a building design can have significant cost implications.

The Hurricane Ike Mitigation Assessment Team (MAT) observed some breakaway walls in excess of 11 feet high. While FEMA promotes elevating homes above the BFE (i.e., adding freeboard), one of the unintended consequences appears to be the increasing size of flood-borne debris elements due to taller breakaway walls.



## Space Below the BFE — What Can It Be Used For?

NFIP regulations state that the area below an elevated building can only be used for **parking, building access, and storage**. These areas must not be finished or used for recreational or habitable purposes. Only minimal electrical equipment is allowed and no mechanical or plumbing equipment is to be installed below the BFE.

## What is an Enclosure?

An “**enclosure**” is formed when any space below the BFE is enclosed on all sides by walls or partitions. Enclosures can be divided into two types—breakaway and non-breakaway.

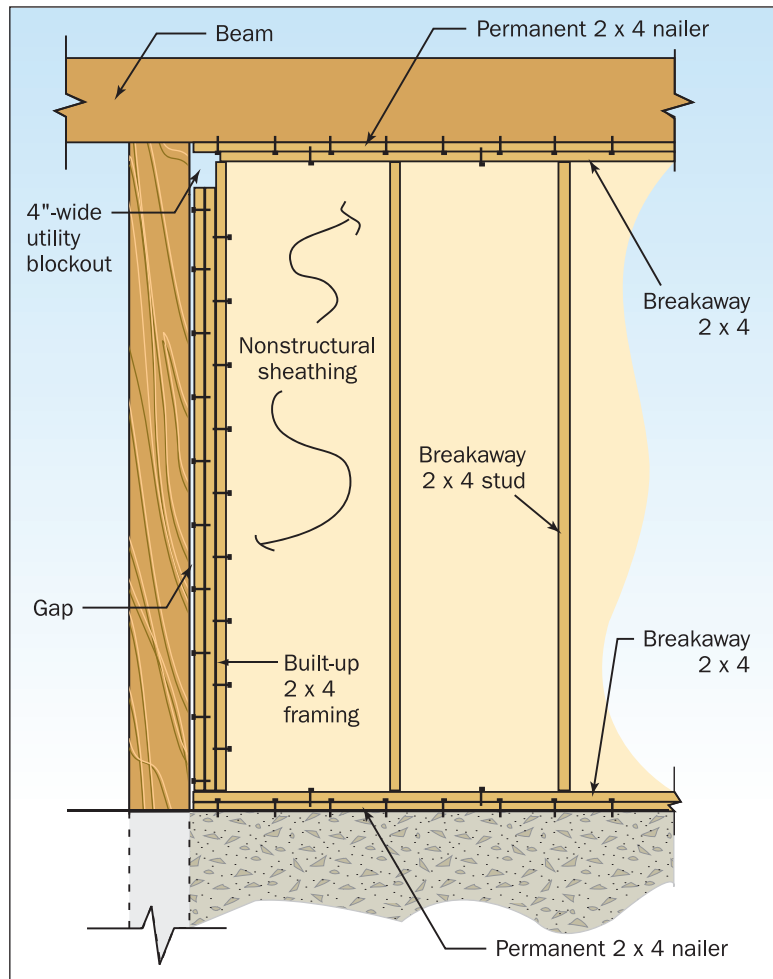
- **Breakaway** enclosures are designed to fail under base flood conditions without jeopardizing the elevated building (Figure 2) – **any below-BFE enclosure in a V Zone must be breakaway**. Breakaway enclosures are permitted in A Zones but must be equipped with flood openings.
- **Non-breakaway enclosures** can be constructed in an A Zone. They may be used to provide structural support to the elevated building. All A Zone enclosures must be equipped with flood openings to allow the automatic entry and exit of floodwaters. **It is recommended that they be used only in A Zone areas subject to shallow, slow-moving floodwaters without breaking waves (i.e., do not use in Coastal A Zones).**

## Breakaway Walls

Breakaway walls must be designed to break free under the larger of the following Allowable Stress Design loads: 1) the design wind load, 2) the design seismic load, or 3) 10 pounds per square foot (psf), acting perpendicular to the plane of the wall (see Figure 3 for an example of a compliant breakaway wall). If the Allowable Stress Design loading exceeds 20 psf for the designed breakaway wall, the **breakaway wall design must be certified**. When certification is required, a registered engineer or architect must certify that the walls will collapse under a water load associated with the base flood and that the elevated portion of the building and its foundation will not be subject to collapse, displacement, or lateral movement under simultaneous wind and water loads. **Breakaway walls must break away cleanly and must not damage the**



**Figure 2. Breakaway walls beneath this building failed as intended under the flood forces of Hurricane Ike.**



**Figure 3. An example of an NFIP-compliant breakaway wall constructed of preservative treated or decay resistant lumber.**

**elevated building** (Figure 4). **Utilities should not be attached to, or pass through, breakaway walls.** See FEMA (2008a) Technical Bulletin 9, *Design and Construction Guidance for Breakaway Walls* for more information.





**Figure 4. Building siding extended down and over the breakaway wall. Lack of a clean separation allowed damage to spread upward as the breakaway wall failed.**

## Obstruction Considerations

A V Zone building, elevated on an open foundation without an enclosure or other obstructions below the BFE, is said to be free of obstructions, and will receive a favorable flood insurance premium (see FEMA (2008b) Technical Bulletin 5-08, *Free-of-Obstruction Requirements* for more information).

The following building scenarios are also classified by the NFIP *Flood Insurance Manual* as **free of obstructions**:

- Below BFE space is surrounded by insect screening and/or by wooden or plastic lattice, slats, or shutters (louvers), if at least 40 percent of the lattice and louver area is open. Lattice can be no thicker than  $\frac{1}{4}$  inch; slats or louvers can be no thicker than 1 inch.
- Below BFE space is surrounded by a combination of one solid breakaway wall (or garage door), and all other sides of the enclosure are either insect screening, wooden or plastic lattice, slats, or louvers.

The following building scenarios are classified by the NFIP *Flood Insurance Manual* as **with obstructions**:

- Below BFE space is fully enclosed by solid breakaway walls.
- Below BFE space is enclosed by a combination of two or more solid breakaway walls, with the remaining sides of the enclosure comprised of either insect screening, or wooden or plastic lattice, slats, or louvers.

## Flood Openings

Foundation walls and other enclosure walls of A Zone buildings (including Coastal A Zone buildings) must be equipped with openings that allow the **automatic entry and exit of floodwaters** (Figure 5).

A Zone opening requirements are as follows:

- Flood openings must be provided in **at least two of the walls** forming the enclosure.
- **The bottom of each opening is to be located no higher than 1 foot above the grade that is immediately under each opening. If the interior and exterior grades are different, the higher of the final interior grade and the finished exterior grade that is immediately under each opening is used to make the determination.**
- **Louvers, screens, or covers** may be installed over flood openings as long as they do not interfere with the operation of the openings during a flood.
- Flood openings may be sized according to either a prescriptive method (1 square inch of flood opening per square foot of enclosed area) or an engineering method (which must be certified by a registered engineer or architect).

Details concerning flood openings can be found in FEMA (2008c) Technical Bulletin 1-08, *Openings in Foundation Walls and Walls of Enclosures*.



**Figure 5. Flood opening in a below-BFE enclosure wall.**

## Other Considerations

Enclosures are strictly regulated because, if not constructed properly, they can transfer flood forces to the main structure (possibly leading to structural collapse). There are other considerations as well.

- Owners may be tempted to convert enclosed areas below the BFE into habitable space, leading to life-safety concerns and uninsured losses. Buildings without enclosures below the lowest floor should be encouraged. If enclosures are constructed, contractors **should not stub out utilities in enclosures** (utility stub-outs make it easier for owners to finish and occupy the space).

- Siding used on the elevated portions of a building should not extend down over breakaway walls. Instead, a clean separation should be provided so that any siding installed on breakaway walls is structurally independent of siding elsewhere on the building. Without such a separation, the failure of breakaway walls can result in damage to siding elsewhere on the building (see Figure 4).
- Solid breakaway wall enclosures in V Zones will result in **higher flood insurance premiums** (especially where the enclosed area is 300 square feet or greater). Insect screening, lattice, slats, or louvers are recommended.

It is recommended to use insect screening, open wooden or plastic lattice, slats, or louvers instead of solid breakaway walls beneath elevated residential buildings.

- If enclosures are constructed in **Coastal A Zones, open foundations with breakaway enclosures are recommended** instead of foundation walls or crawlspaces. If solid breakaway walls are used, then they must be equipped with flood openings that allow floodwaters to enter and exit the enclosure. Use of breakaway enclosures in Coastal A Zones (or any A Zone) will not lead to higher flood insurance premiums.

It is recommended that flood openings be considered for solid breakaway walls in V Zones, even though they are not required by the NFIP. The presence of flood openings may relieve flood forces against the solid breakaway walls, reduce damage to the walls, and reduce flood-borne debris.

- Garage doors installed in below-BFE enclosures of V Zone buildings—even reinforced and high-wind-resistant doors—must meet the performance requirement discussed in the *Breakaway Walls* section of this Fact Sheet. Specifically, the doors must be designed to break free under the larger of the following Allowable Stress Design loads: design wind load, the design seismic load, or 10 psf, acting perpendicular to the plane of the door. If the Allowable Stress Design load exceeds 20 psf for the designed door, **the door must be designed and certified to collapse under base flood conditions**. See the *Breakaway Walls* section for information about certification requirements.

There are two other enclosure scenarios that should be mentioned, both of which have construction and flood insurance consequences. Contractors and designers should be cautious when an owner asks for either type of enclosure, and consultation with the community and a knowledgeable flood insurance agent is recommended.

- **Below-BFE enclosures** that do not extend all the way to the ground (sometimes called “hanging” enclosures or “elevated” enclosures, occurs when there is an enclosure floor system tied to the building foundation and above the ground – see Figure 6). In V Zones, the enclosure walls must be breakaway, and the enclosure floor system must either break away or the building foundation must be designed to accommodate flood loads transferred from the enclosure floor system to the foundation. In V Zones, the enclosure walls must be breakaway, and the enclosure floor system must either break away or the building foundation must be designed to accommodate flood loads transferred from the enclosure floor system to the foundation.



**Figure 6. Example of an enclosure that does not extend to grade. This type of enclosure presents special construction and flood insurance issues. Contractors should proceed with caution when an owner requests such an enclosure.**

- In A Zones, the enclosure walls must have proper flood vents, with the bottom no higher than 1 foot above the enclosure floor. These types of enclosures were not contemplated when flood insurance premium rate tables were constructed, and can result in significantly higher flood insurance premiums than had the enclosure walls extended to the ground. The NFIP is working to correct this rating issue; until then, owners will pay a substantial premium penalty for this type of construction.

■ **Two-story enclosures** below elevated buildings (see Figure 7). As some BFEs are established higher and higher above ground, some owners have constructed two-story solid wall enclosures below the elevated building, with the upper enclosure having a floor system approximately midway between the ground and the elevated building. These types of enclosures present unique problems. In A Zones both levels of the enclosure must have flood openings in the walls unless there is some way to relieve water pressure through the floor system between the upper and lower enclosures; in V Zones, the enclosure walls (and possibly enclosure floor systems) must be breakaway; special ingress and egress code requirements may be a factor; these enclosures may result in substantially higher flood insurance premiums.



**Figure 7. Example of a two-story enclosure below the BFE. This type of enclosure presents special construction and flood insurance issues. Contractors should proceed with caution when an owner requests such an enclosure.**

## Additional Resources

FEMA. 2008a. *Design and Construction Requirements for Breakaway Walls*. Technical Bulletin 9-08, (<http://www.fema.gov/library/viewRecord.do?id=1722>).

FEMA. 2008b. *Free-of-Obstruction Requirements*. Technical Bulletin 5-08, (<http://www.fema.gov/library/viewRecord.do?id=1718>).

FEMA. 2008c. *Openings in Foundation Walls and Walls of Enclosures*. Technical Bulletin 1-08, (<http://www.fema.gov/library/viewRecord.do?id=1579>).

FEMA. 2009. *Hurricane Ike Recovery Advisory, Design and Construction in Coastal A Zones*, (<http://www.fema.gov/library/viewRecord.do?id=1569>).

*Developed in association with the National Association of Home Builders Research Center*





# Decks, Pools, and Accessory Structures

**Purpose:** To summarize National Flood Insurance Program (NFIP) requirements and general guidelines for the construction and installation of decks, access stairs and elevators, swimming pools, and accessory buildings under or near coastal buildings.

## Key Issues

- Any deck, accessory building, or other construction element that is structurally dependent on or attached to a building in V Zone is considered part of the building and must meet the NFIP regulatory requirements for construction in V Zone (see NFIP Technical Bulletin 5-08 and Fact Sheet Nos. 1.2, 1.4, 1.5, 1.7, 3.1, 8.1, 9.1). Attached construction elements that do not meet these requirements are prohibited.
- If prohibited elements are attached to a building that is otherwise compliant with NFIP requirements, a higher flood insurance premium may be assessed against the entire building.
- Swimming pools, accessory buildings, and other construction elements outside the perimeter (footprint) of, and not attached to, a coastal building may alter the characteristics of flooding significantly or increase wave or debris impact forces affecting the building and nearby buildings. If such elements are to be constructed, a design professional should consider their potential effects on the building and nearby buildings.
- This *Home Builder's Guide to Coastal Construction* strongly recommends that all decks, pools, accessory structures, and other construction elements in Zone A in coastal areas be designed and constructed to meet the NFIP V Zone requirements.
- Post-storm investigations frequently reveal envelope and structural damage (to elevated buildings) initiated by failure of a deck due to flood



**Damage from Hurricane Opal in Florida. This deck was designed to meet State of Florida Coastal Construction Control Line (CCCL) requirements. The house predated the CCCL and did not meet the requirements.**

and/or wind forces. Decks should be given the same level of design and construction attention as the main building, and failure to do so could lead to severe building damage.

## Decks

### Requirements

- If a deck is structurally attached to a building in Zone V, the bottom of the lowest horizontal member of the deck must be elevated to or above the elevation of the bottom of the building's lowest horizontal member.
- A deck built below the Design Flood Elevation (DFE) must be structurally independent of the main building and must not cause an obstruction.
- If an at-grade, structurally independent deck is to be constructed, a design professional must



evaluate the proposed deck to determine whether it will adversely affect the building and nearby buildings (e.g., by diverting flood flows or creating damaging debris).

## Recommendations

- Decks should be built on the same type of foundation as the primary building. Decks should be structurally independent of the primary structure and designed to resist the expected wind and water forces.
- Alternatively, decks can be cantilevered from the primary structure; this technique can minimize the need for additional foundation members.
- A “breakaway deck” design is discouraged because of the large debris that can result.
- A “breakaway deck” on the seaward side poses a damage hazard to the primary structure.
- Decks should be constructed of flood-resistant materials, and all fasteners should be made of corrosion-resistant materials.

## Access Stairs and Elevators Requirements

- Open stairs and elevators attached to or beneath an elevated building in V Zone are excluded from the NFIP breakaway wall requirements (see NFIP Technical Bulletin 5-08 and Fact Sheet No. 8.1), but must meet the NFIP requirement for the use of flood-resistant materials (see NFIP Technical Bulletin 2-08 and Fact Sheet No. 1.7). Large solid staircases that block flow under a building are a violation of NFIP free-of-obstruction requirements (see NFIP Technical Bulletin 5-08)



***The rails on these stairs were enclosed with siding, presenting a greater obstacle to the flow of flood water and contributing to the flood damage shown here.***

- Although they need not be designed to break away under flood forces, access stairs and elevators are obstructions; therefore, the loads they may transfer to the main building must be considered by the design professional.



***Large solid stairs such as these block flow under a building and are a violation of NFIP free-of-obstruction requirements.***

## Recommendations

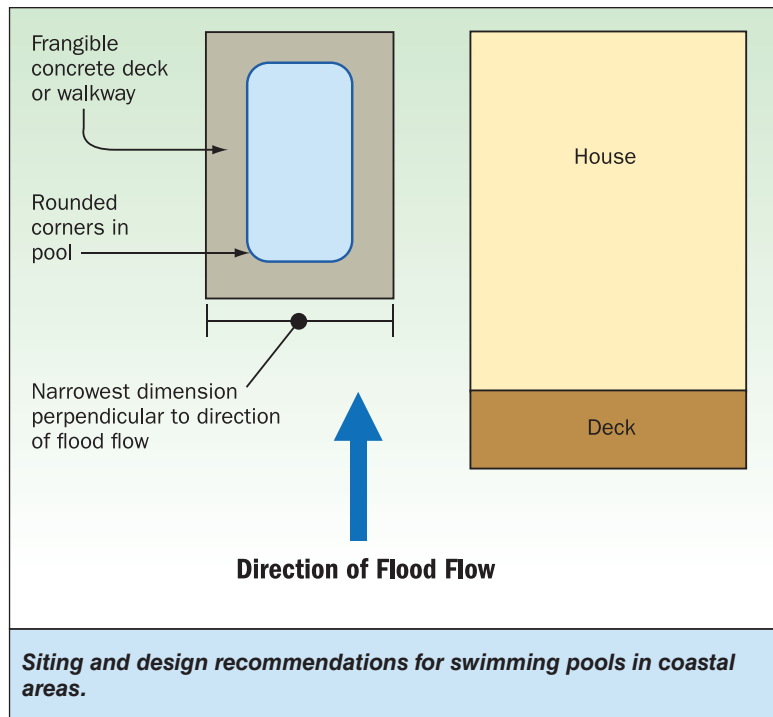
- Open stair handrails and risers should be used because they allow wind and water to pass through rather than act as a barrier to flow.
- The bottom of the stair, like the foundation of the primary structure, should be designed and constructed to remain in place during a windstorm or a flood.
- Stairways not considered the primary means of egress can be constructed with hinged connections that allow them to be raised in the event of an impending storm or flood (check code requirements before employing this technique).
- Elevators should be installed in accordance with the guidance in NFIP Technical Bulletin 4-93 and the building code.

## Swimming Pools Requirements

- An at-grade or elevated pool adjacent to a coastal building is allowed only if the pool will not act as an obstruction that will result in damage to the building or nearby buildings.
- When a pool is constructed near a building in Zone V, the design professional must assure community officials that the pool will not increase the potential for damage to the foundation or elevated portion of the building or any nearby

buildings. Pools can be designed to break up (“frangible pools”) during a flood event, thereby reducing the potential for adverse impacts on nearby buildings.

- Any pool constructed adjacent to a coastal building must be structurally independent of the building and its foundation.
- A swimming pool may be placed beneath a coastal building only if the top of the pool and the accompanying pool deck or walkway are flush with the existing grade and only if the lower area (below the lowest floor) remains unenclosed. Under the NFIP, lower-area enclosures around pools constitute a recreational use and are not allowed, even if constructed to breakaway standards.



## Recommendations

- Pools should be oriented with their narrowest dimension perpendicular to the direction of flood flow.
- Concrete decks or walkways around pools should be frangible (i.e., they will break apart under flood forces).
- Molded fiberglass pools should be installed and elevated on a pile-supported structural frame.
- No aboveground pools should be constructed in V Zone unless they are above the DFE and have an open, wind- and flood-resistant foundation.
- Pool equipment should be located above the DFE whenever practical.
- Check with community officials before constructing pools in Zone V.

## Accessory Buildings

### Requirements

- Unless properly elevated (to or above the DFE) on piles or columns, an accessory building in V Zone is likely to be destroyed during a coastal storm; therefore, these buildings must be limited to small, low-value structures (e.g., small wood or metal sheds) that are disposable. See NFIP Technical Bulletin 5-08.
- If a community wishes to allow unelevated accessory buildings, it must define “small” and “low cost.” NFIP Technical Bulletin 5-08 defines “small” as less than 100 square feet and “low cost” as less than \$500. Unelevated accessory

buildings must be unfinished inside, constructed with flood-resistant materials, and used only for storage.

- When an accessory building is placed in Zone V, the design professional must determine the effect that debris from the accessory building will have on nearby buildings. If the accessory building is large enough that its failure could create damaging debris or divert flood flows, it must be elevated above the DFE.

## Recommendations

- Whenever practical, accessory buildings should not be constructed. Instead, the functions of an accessory building should be incorporated into the primary building.
- All accessory buildings should be located above the DFE whenever practical.
- All accessory buildings should be designed and constructed to resist the locally expected wind and water forces whenever practical.
- The roof, wall, and foundation connections in accessory buildings should meet the requirements for connections in primary buildings.
- Accessory buildings below the DFE should be anchored to resist being blown away by high winds or carried away by floodwaters.

- Accessory buildings (including their foundations) must not be attached to the primary building; otherwise, failure of the accessory building could damage the primary building.
- Orienting the narrowest dimension of an accessory building perpendicular to the expected flow of water will create less of an obstruction to flowing water or wave action, and may result in less damage.



**Small accessory building anchored to resist wind forces.**

## Additional Resources

FEMA. NFIP Technical Bulletin 2-08, *Flood Damage-Resistant Materials Requirements for Buildings Located in Special Flood Hazard Areas*. (<http://www.fema.gov/library/viewRecord.do?id=1580>)

FEMA. NFIP Technical Bulletin 4-10, *Elevator Installation for Buildings Located in Special Flood Hazard Areas*. (<http://www.fema.gov/library/viewRecord.do?id=1717>)

FEMA. NFIP Technical Bulletin 5-08, *Free-of-Obstruction Requirements for Buildings Located in Coastal High Hazard Areas*. (<http://www.fema.gov/library/viewRecord.do?id=1718>)



# Protecting Utilities

**Purpose:** *To identify the special considerations that must be made when installing utility equipment in a coastal home.*

## Key Issues:

**Hazards, requirements, and recommendations** – Special considerations must be made when installing utility systems in coastal homes. **Proper placement and connection** of utilities and mechanical equipment can **significantly reduce the costs of damage caused by coastal storms** and will **enable homeowners to reoccupy** their homes soon after electricity, sewer, and water are restored to a neighborhood.



*Electrical lines and box dislocated by hurricane forces.*

## Coastal Hazards That Damage Utility Equipment

- Standing or moving floodwaters
- Impact from floating debris in floodwaters
- Erosion and scour from floodwaters
- High winds
- Windborne missiles

## Common Utility Damage in Coastal Areas

Floodwaters cause corrosion and contamination, short-circuiting of electronic and electrical equipment, and other physical damage.

**Electrical** – Floodwaters can corrode and short-circuit electrical system components, possibly leading to electrical shock. In velocity flow areas, electrical panels can be torn from their attachments by the force of breaking waves or the impact of floating debris.

**Water/Sewage** – Water wells can be exposed by erosion and scour caused by floodwaters with velocity flow. A sewage backup can occur even without the structure flooding.

**Fuel** – Floodwaters can float and rupture tanks, corrode and short-circuit electronic components, and sever pipe connections. In extreme cases, damage to fuel systems can lead to fires.

## Basic Protection Methods

The primary protection methods are **elevation** or **component protection**.

### Elevation

Elevation refers to the location of a component and/or utility system above the Design Flood Elevation (DFE).

### Component Protection

Component protection refers to the implementation of design techniques that protect a component or group of components from flood damage when they are located below the DFE.

## NFIP Utility Protection Requirements

The NFIP regulations [Section 60.3(a)(3)] state that:

**All new construction and substantial improvements shall be constructed with electrical, heating, ventilation, plumbing, and air conditioning equipment and other service facilities that are designed and/or located so as to prevent water from entering or accumulating within the components during conditions of flooding.**

*Elevation of utilities and mechanical equipment is the preferred method of protection.*



## Utility Protection Recommendations

### Electrical

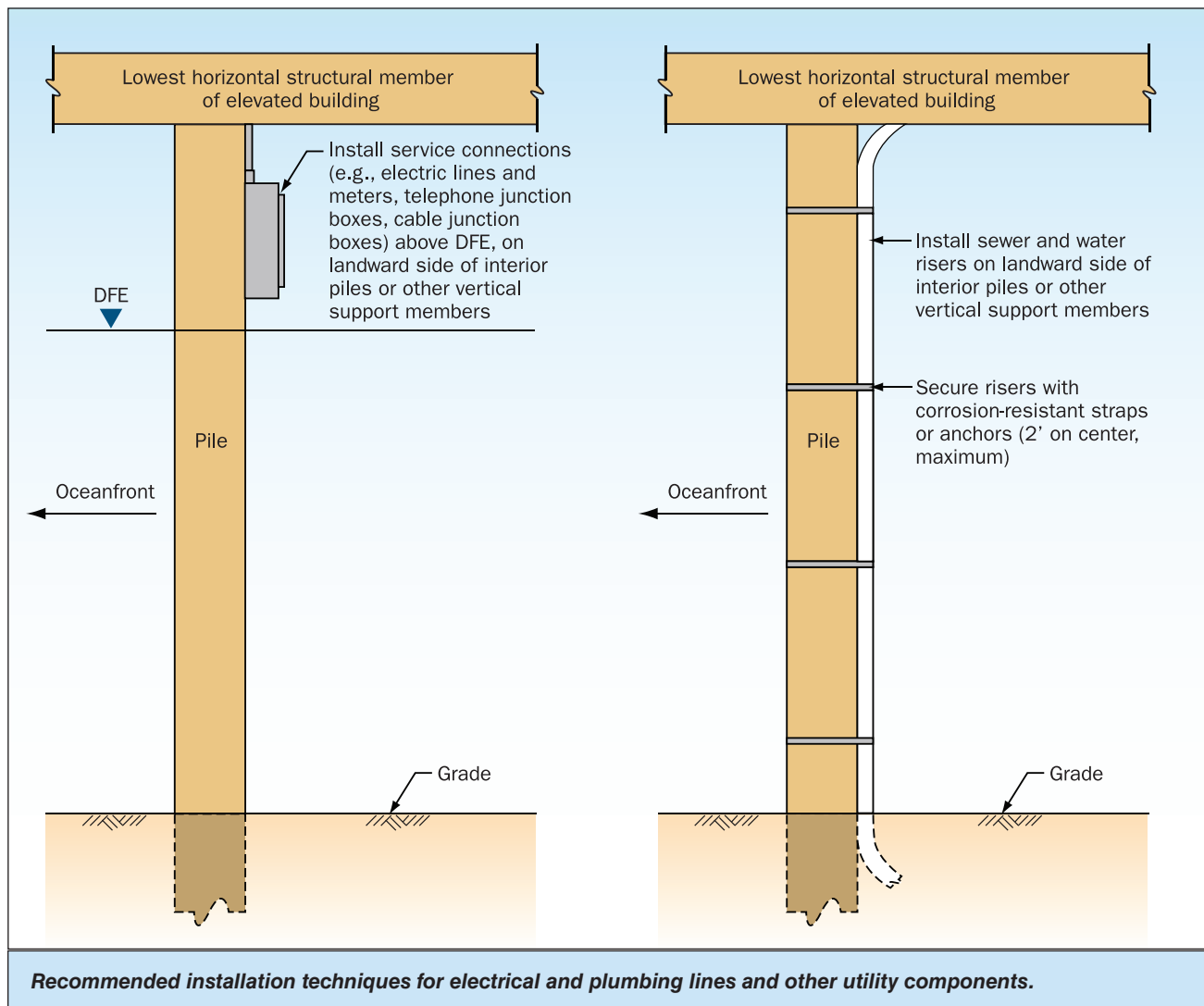
- Limit switches, wiring, and receptacles below the DFE to those items required for life safety. Substitute motion detectors above the DFE for below-DFE switches whenever possible. Use only ground-fault-protected electrical breakers below the DFE.
- Install service connections (e.g., electrical lines, panels, and meters; telephone junction boxes; cable junction boxes) above the DFE, on the landward side of interior piles or other vertical support members.
- Use drip loops to minimize water entry at penetrations.
- Never attach electrical components to breakaway walls.

### Water/Sewage

- Attach plumbing risers on the landward side of interior piles or other vertical support members.
- When possible, install plumbing runs inside joists for protection.
- Never attach plumbing runs to breakaway walls.

### HVAC

- Install HVAC components (e.g., condensers, air handlers, ductwork, electrical components) above the DFE.
- Mount outdoor units on the leeward side of the building.
- Secure the unit so that it cannot move, vibrate, or be blown off its support.
- Protect the unit from damage by windborne debris.



## Fuel

- Fuel tanks should be installed so as to prevent their loss or damage. This will require one of the following techniques: (1) elevation above the DFE and anchoring to prevent blowoff, (2) burial and anchoring to prevent exposure and flotation during erosion and flooding, (3) anchoring at ground level to prevent flotation during flooding and loss during scour and erosion. The first method (elevation) is preferred.
- Any anchoring, strapping, or other attachments must be designed and installed to resist the effects of corrosion and decay.



*Elevated air conditioning compressors.*

## Additional Resources

American Society of Civil Engineers. *Flood Resistant Design and Construction* (SEI/ASCE 24-05). (<http://www.asce.org>)

FEMA. *Free-of-Obstruction Requirements*. Technical Bulletin 5-08, (<http://www.fema.gov/library/viewRecord.do?id=1718>).

FEMA. *Protecting Building Utilities From Flood Damage*. FEMA 348. November 1999. (<http://www.fema.gov/library/viewRecord.do?id=1750>)



# Repairs, Remodeling, Additions, and Retrofitting – Flood

**Purpose:** *To outline National Flood Insurance Program (NFIP) requirements for repairs, remodeling, and additions, and opportunities for retrofitting in coastal flood hazard areas; to provide recommendations for exceeding those minimum requirements.*

## Key Issues

- Existing buildings that sustain substantial damage or that are substantially improved (see box on page 3) will be treated as new construction and must meet the community's current flood-resistant construction requirements (e.g., lowest floor elevation, foundation, and enclosure requirements).
- Work on post-Flood Insurance Rate Map (FIRM)<sup>1</sup> existing buildings that are not substantially damaged or substantially improved (see box on page 3) must meet the community's flood-resistant construction requirements that were in effect when the building was originally constructed.
- Work on pre-FIRM<sup>1</sup> existing buildings that are not substantially damaged or substantially improved (see box on page 3) is not subject to NFIP flood-resistant construction requirements.
- With some minor exceptions (e.g., code violations and historic buildings), substantial damage and substantial improvement requirements apply to all buildings in the flood hazard area, whether or not a flood insurance policy is in force.
- Buildings damaged by a flood and covered by flood insurance may be eligible for additional payments through the Increased Cost of Compliance (ICC) policy provisions. Check with an insurance agent and the authority having jurisdiction (AHJ) for details.
- Repairs and remodeling—either before or after storm damage—provide many opportunities for retrofitting homes and making them more resistant to flood damage.

## Factors That Determine Whether and How Existing Buildings Must Comply With NFIP Requirements

Rules governing the applicability of NFIP new construction requirements to existing buildings are confusing to many people; this fact sheet and Fact Sheet No. 1.2, Summary of Coastal Construction Requirements and Recommendations for Flood Effects provide guidance on the subject.

When repairs, remodeling, additions, or improvements to an existing building are undertaken, four basic factors determine whether and how the existing building must comply with NFIP requirements for new construction:

- **Value of damage/work**— whether the cost of repairs to the damaged building triggers substantial damage or substantial improvement regulations (see page 3).
- **Nature of work**— whether the work involves an expansion of the building, either laterally or vertically (an addition), or an enclosure of space below the Base Flood Elevation (BFE), or the demolition and reconstruction of an existing building, or the relocation of an existing building.

**Note:** Repairs, remodeling, additions, and retrofitting may also be subject to other community and code requirements, some of which may be more restrictive than the NFIP requirements. Check with the AHJ before undertaking any work.

<sup>1</sup> Pre-FIRM is defined as a building for which construction or substantial improvement occurred on or before December 31, 1974, or before the effective date of the initial Flood Insurance Rate Map (FIRM) for the community. Post-FIRM is defined as a building for which construction or substantial improvement occurred after December 31, 1974, or on or after the effective date of the initial Flood Insurance Rate Map (FIRM) for the community.

<sup>2</sup> This fact sheet and Fact Sheet No. 2 recommend meeting current NFIP/community requirements in these instances.



- **Pre-FIRM or post-FIRM building**– different requirements may apply to pre-FIRM existing buildings.
- **Flood zone**– different requirements may apply in V Zones and A Zones (this includes both the Coastal A Zone and A Zone).

Two other factors may need to be considered (consult the AHJ regarding whether and how these factors apply):

- **Code violations**– if cited by a code official, the NFIP regulations exempt certain work to correct existing violations of state or local health, sanitary, or safety code requirements from the substantial improvement and substantial damage calculations.
- **Historic structures**– a building that is on the National Register of Historic Places or that has been designated as historic by federally certified state or local historic preservation offices (or that is eligible for such designation) may be exempt from substantial damage and substantial improvement requirements, provided any work on the building does not cause the building to lose its historic designation.

#### A Zones Subject to Breaking Waves and Erosion

*Home Builder's Guide to Coastal Construction (HBGCC) Recommendations:* Treat buildings and lateral additions in A Zones subject to breaking waves and erosion like V Zone buildings. Elevate all A Zone lateral additions (except garages) such that the bottom of the lowest horizontal structural member is at, or above, the DFE. For garages (in A Zones subject to breaking waves and erosion) below the DFE, construct with breakaway walls.

## Code Compliance

Definitions from the International Code Council Model Building Codes

**ADDITION:** An extension or increase in floor area or height of a building or structure.

**ALTERATION:** Any construction or renovation to an existing structure other than repair or addition that requires a permit. Also, a change in a mechanical system that involves an extension, addition or change to the arrangement, type or purpose of the original installation that requires a permit.

**REPAIR:** The reconstruction or renewal of any part of an existing building for the purpose of its maintenance.

### 2009 International Residential Code Requirements for Additions, Alterations or Repairs

R102.7.1 Additions, alterations or repairs. Additions, alterations, or repairs to any structure shall conform to the requirements for a new structure without requiring the existing structure to comply with all of the requirements of this code, unless otherwise stated. Additions, alterations or repairs shall not cause an existing structure to become unsafe or adversely affect the performance of the building.

#### What Is Substantial Damage?

Substantial damage is damage, **of any origin**, where the cost to restore the building to its pre-damage condition equals or exceeds 50 percent of the building's market value before **the damage occurred**.

#### What Is Substantial Improvement?

Substantial improvement is any reconstruction, rehabilitation, addition, or improvement of a building, the cost of which equals or exceeds **50 percent of the building's pre-improvement market value**.

**When repairs and improvements are made simultaneously**, all costs are totaled and compared with the 50 percent of market value threshold.

## Substantial Damage and Substantial Improvement

It is not uncommon for existing coastal buildings to be modified or expanded over time, often in conjunction with the repair of storm damage. *All repairs, remodeling, improvements, additions, and retrofitting to buildings in flood hazard areas must be carried out in conformance with floodplain management ordinances pertaining to substantial improvement and substantial damage.*

### What Costs Are Included in Substantial Damage and Substantial Improvement Determinations?

- All **structural items and major building components** (e.g., foundations; beams; trusses; sheathing; walls and partitions; floors; ceilings; roof covering; windows and doors; brick, stucco, and siding; attached decks and porches).

- **Interior finish elements** (e.g., tile, vinyl flooring, stone, carpet; plumbing fixtures; gypsum wall-board and wall finishes; built-in cabinets, book-cases and furniture; hardware).
- **Utility and service equipment** (e.g., HVAC equipment; plumbing and wiring; light fixtures and ceiling fans; security systems; built-in appliances; water filtration and conditioning systems).
- Market value of **all labor and materials** for repairs, demolition, and improvements, including management, supervision, overhead, and profit (do not discount volunteer or self-labor or donated/discounted materials).

## What Costs Are Not Included in Substantial Damage and Substantial Improvement Determinations?

- **Design costs** (e.g., plans and specifications, surveys and permits).
- **Clean-up** (e.g., debris removal, transportation, and landfill costs).
- **Contents** (e.g., furniture, rugs, appliances not built in).
- **Outside improvements** (e.g., landscaping, irrigation systems, sidewalks and patios, fences, lighting, swimming pools and hot tubs, sheds, gazebos, detached garages).

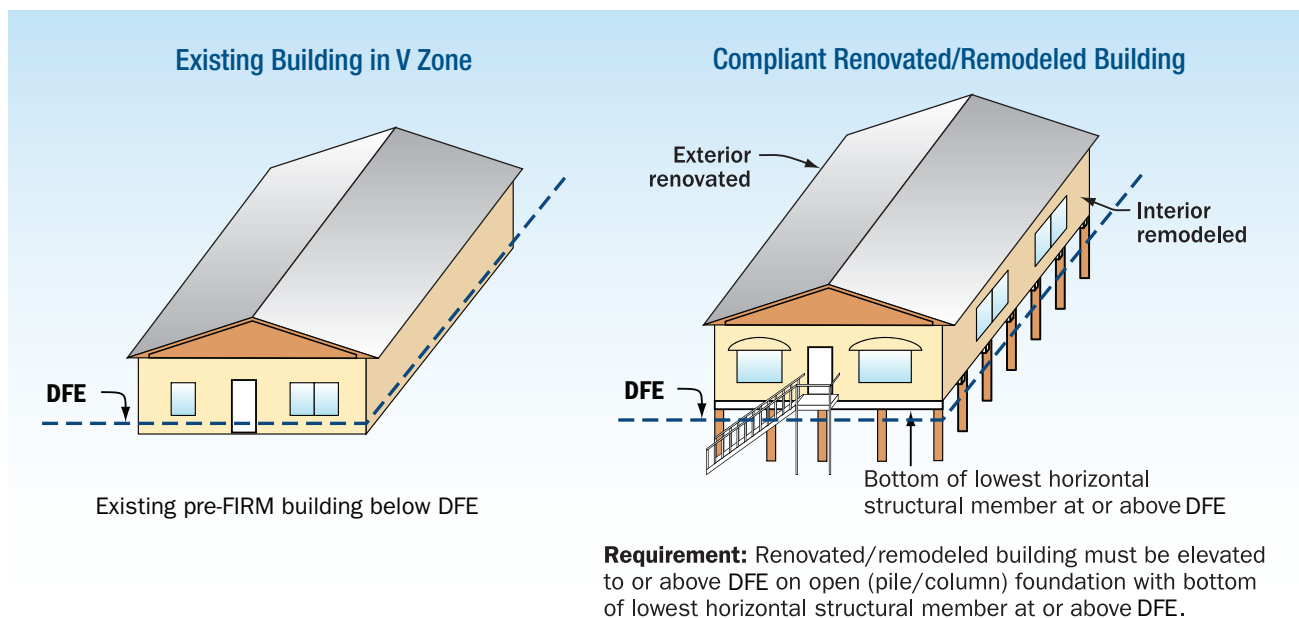
**Note:** Some jurisdictions have enacted more restrictive requirements—some use a less-than-50-percent damage/improvement threshold. Some track the cumulative value of damage and improvements over time. Consult the AHJ for local requirements.

## Additions

Additions increase the square footage or external dimensions of a building. They can be divided into *lateral additions*, *vertical additions*, and *enclosures of areas below existing buildings*. When considering additions, it is important to consider that changes to the shape of the building may impact the potential damages to the house. A lateral addition may change the way flood waters travel around the structure and potentially create obstructions for flood-borne debris that may require additional foundation modifications. Vertical additions may also impose greater loads on the existing structure. A qualified design professional should evaluate the loading to the entire structure to see if additional structural modifications are required in order to maintain the structure's ability to sustain flood loading.

## Lateral Additions

- If a *lateral addition* constitutes a substantial improvement to a V Zone building, *both the addition and the existing building must comply* with the effective base flood elevation, foundation, and other flood requirements for new V Zone construction (see Figure 1).

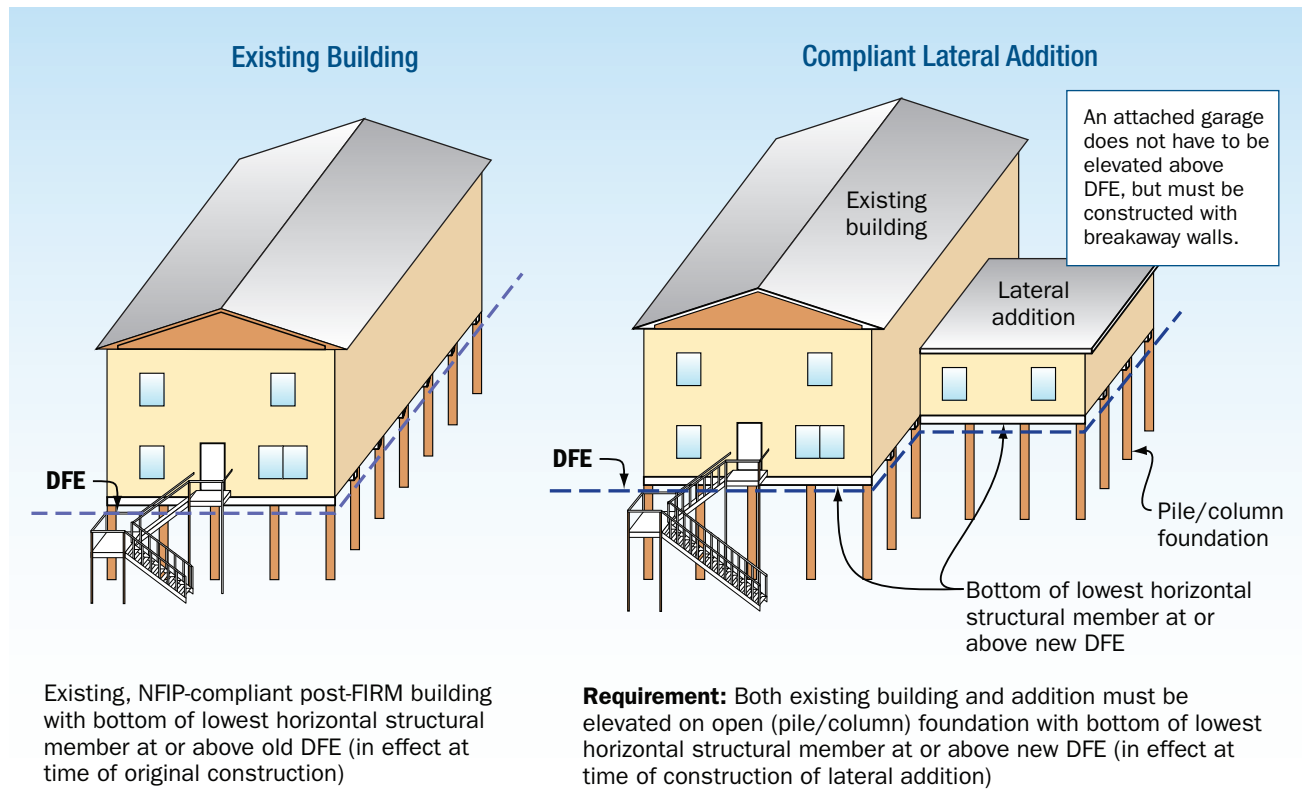


**Figure 1. Substantial improvement: Renovated/remodeled building in a V Zone.**

- If a lateral addition constitutes a substantial improvement to an A Zone building, only the addition must comply with the current floor elevation, foundation, and other flood requirements for new construction, as long as the alterations to the existing building are the minimum necessary.<sup>3</sup> *Minimum alterations necessary* means the existing building is not altered, except for cutting an entrance through the existing building wall into the addition, and except for the minimum alterations necessary to tie the addition to the building. If more extensive alterations are made to the existing building, it too must be brought into compliance with the requirements for new construction.
- If a lateral addition to a pre-FIRM building does not constitute a substantial improvement, neither the addition nor the existing building must be

elevated. However, the HBGCC recommends that both the existing building and the addition be elevated to, or above, the current DFE, in a manner consistent with current NFIP requirements for new construction, and using a V Zone-type foundation in V Zones and in Coastal A Zones.

- If a lateral addition to a post-FIRM building does not constitute a substantial improvement, the addition must be elevated in accordance with the flood requirements in effect at the time the building was originally constructed, even if the BFE and flood hazard have changed over time. The HBGCC recommends that both the existing building and the addition be elevated to, or above, the current DFE, in a manner consistent with current NFIP requirements for new construction, and using a V Zone-type foundation in V Zones and in Coastal A Zones (see Figure 2).



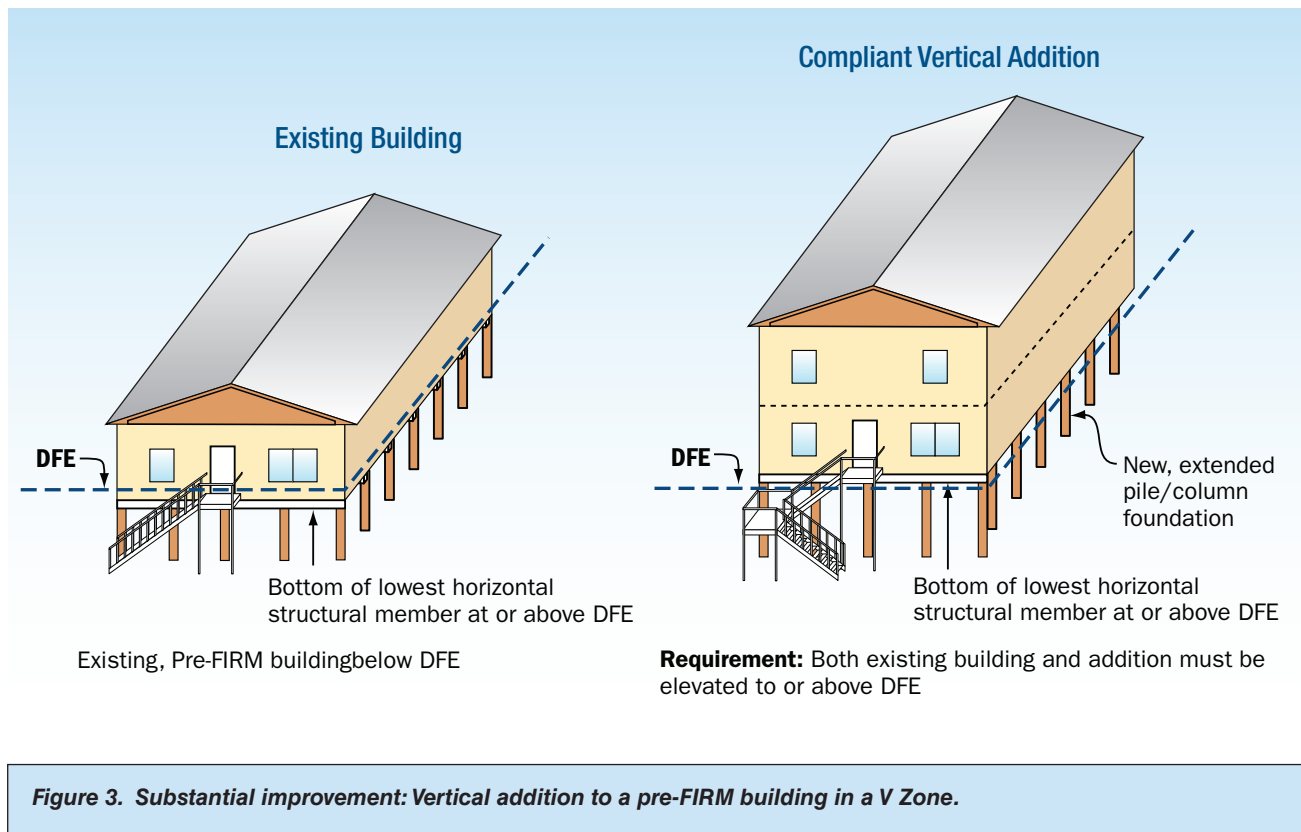
**Figure 2. Substantial improvement: Lateral addition to a pre-FIRM building in a V Zone.**

<sup>3</sup> However, the HBGCC recommends that both the existing building and the addition be elevated to, or above, the current DFE, in a manner consistent with current NFIP requirements, and using a V Zone-type foundation in Coastal A Zones.



## Vertical Additions

- If a vertical addition to a V Zone or A Zone building constitutes a substantial improvement, both the addition and the existing building must comply with the effective base flood elevation, foundation, and other flood requirements for new construction (see Figure 3).
- If a vertical addition to a pre-FIRM V Zone or A Zone building does not constitute a substantial improvement, neither the addition nor the existing building must be elevated or otherwise brought into compliance with NFIP requirements. However, the HBGCC recommends that both the addition and the existing building be elevated to, or above, the current DFE in a manner consistent with current NFIP requirements for new construction, and using a V Zone-type foundation in V Zones and in Coastal A Zones (see Figure 3). The HBGCC also recommends strongly against using any space below the current BFE for habitable uses (uses permitted by the NFIP are parking, storage, and building access).
- If a vertical addition to a post-FIRM V Zone or A Zone building does not constitute a substantial improvement, the addition must be designed and constructed in accordance with the flood requirements in effect at the time the building was originally constructed. However, BFEs and flood zones change over time as areas are remapped. The HBGCC recommends that both the addition and the existing building be elevated to, or above, the current DFE in a manner consistent with current NFIP requirements for new construction, and using a V Zone-type foundation in V Zones and in Coastal A Zones. The HBGCC also recommends strongly against using any space below the current BFE for habitable uses (uses permitted by the NFIP are parking, storage, and building access).



## Enclosures of Areas Below Existing Buildings

Enclosures below existing buildings are treated like vertical additions.

Existing NFIP requirements: (1) do not enclose and convert to habitable use any space below the BFE under any circumstances, and (2) construct only breakaway enclosures below existing buildings in V Zones and in Coastal A Zones. HBGCC recommendation: in V Zones and Coastal A Zones the area below the BFE should be built free of obstruction. Use open lattice, screening, or breakaway walls. For requirements concerning enclosures below elevated buildings see Fact Sheet 8.1. It should be noted that enclosures built with breakaway walls below the BFE may result in increased insurance premiums when compared to an open foundation.

## Reconstruction of a Destroyed or Razed Building

In all cases (pre-FIRM or post-FIRM, V Zone or A Zone) where an entire building is destroyed or purposefully demolished or razed, the replacement building is considered “new construction” and *the replacement building must meet the current NFIP requirements*, even if it is built on the foundation of the original building.

## Moving an Existing Building

When an existing building (pre-FIRM or post-FIRM, V Zone or A Zone) is moved to a new location or site, the work is considered “new construction” and if the relocated building is in the SFHA, it must be installed so as to comply with NFIP requirements.

## Materials

When constructing in coastal environments, carefully consider what construction materials to select. The NFIP Technical Bulletin 2, *Flood Damage-Resistant Materials Requirements* (August 2008), provides valuable information regarding the applicability of various construction materials in a coastal environment. For additional information, see Fact Sheet 1.7, Coastal Building Materials. Following a storm event, repairs should not be started until the problem is properly evaluated and materials are selected that will entirely remedy the damage. All costs of repairs should be identified and quantified prior to starting repairs.

## Repairs

Correction of only the apparent surface damage can lead to unaddressed or overlooked problems beneath the surface that can potentially cause major issues with the structural stability of the building. Proper inspections of damage often not only require demolition or removal of the physically damaged

building component, but also removal of associated exterior cladding. Wind-driven rain for example can lead to compromised connections and the decaying or rotting of building materials that may not be visible without further investigation.

## Insurance Consequences

Designers and owners should know that the work described previously may have insurance consequences, especially if not completed strictly in accordance with NFIP requirements.

In general, most changes to an existing building that result from less-than-substantial damage, or that do not constitute substantial improvement, will not change the status from pre-FIRM to post-FIRM. However, it is required that substantially improved or substantially damaged buildings be brought into compliance. NFIP flood insurance policies on those buildings are written using rates based on elevation. In most cases, the premium will decrease when a pre-FIRM building is substantially improved and brought into compliance. The building becomes a post-FIRM building and premiums are calculated using elevation rates. Failure to comply with the substantial damage or substantial improvement requirements will result in a building’s status being changed and in higher flood insurance premiums. For example:

- If an NFIP-compliant enclosure built with breakaway walls is added below a post-FIRM V Zone building, the building will no longer be rated as “free of obstructions.” Flood insurance premiums on these buildings will be higher. If the enclosure is not compliant with all NFIP requirements, higher premiums will result.
- If work on an existing V Zone building constitutes a substantial improvement, the building will be rated on a current actuarial basis. Any pre-FIRM designation will be lost and current post-FIRM rates will be used.
- If an NFIP-compliant lateral addition constituting a substantial improvement is made to a pre-FIRM A Zone building and no changes were made to the existing building, the building will retain its pre-FIRM designation and rating. However, if the addition does not comply with all requirements, or if more than the minimum alteration necessary was made to the existing building, the building and addition’s lowest floor must be elevated to or above the BFE. The building including the addition will be rated with post-FIRM actuarial rates.

## Retrofit and Remodeling Opportunities

Retrofit opportunities will likely present themselves any time repair or maintenance work is undertaken for a major element of a building. Improvements to the building that are made to increase resistance to

the effects of natural hazards should focus on those items that will potentially return the largest benefit to the building owner. Some examples of retrofit opportunities may include:

- Improving **floor-framing-to-beam** connections whenever they are accessible (see Fact Sheet 4.1, *Load Paths* and Fact Sheet 4.3, *Use of Connectors and Brackets* for additional information).
- Improving **beam-to-pile connections** whenever they are accessible (see Fact Sheet 3.3, *Wood-Pile-to-Beam Connections* for additional information).
- Periodically checking and inspecting **flood openings** to make sure that they are not blocked and functioning properly. If the house is older, check to make sure that flood openings are sized correctly. Consult NFIP Technical Bulletin 1, *Openings In Foundation Walls and Walls of Enclosures* (August 2008) for proper flood opening guidance. Also see Fact Sheet 3.5, *Foundation Walls* for additional information.
- At any time deficient **metal connectors** are found, they should be replaced with stainless steel connectors or metal connectors with proper corrosion protection, such as hot-dip galvanized steel (see Fact Sheet 1.7, *Coastal Building Materials* for additional information).
- When **HVAC equipment** is replaced, the replacement equipment selected should incorporate a more corrosion-resistant design—so that it will last longer in a coastal environment—and should be elevated to, or above, the DFE. The equipment should be adequately anchored to resist wind and seismic loads (see Fact Sheet 8.3, *Protecting Utilities* for additional information).
- Improving **utility attachments** when the outside equipment is replaced or relocated (see Fact Sheet 8.3, *Protecting Utilities* for additional information).
- To minimize the effects of corrosion, carbon steel **handrails** can be replaced at any time with vinyl-coated, plastic, stainless steel, or wood handrails. Wood handrails may require frequent treatment or painting and appropriate fasteners must be used (see Fact Sheet 1.7, *Coastal Building Materials* for additional information). Carbon steel handrails may also be painted with a zinc-rich, vinyl, or epoxy paint appropriate for exposed wet and salt-spray environments. Regardless of the product used, proper maintenance is always necessary in order to ensure a safe handrail.
- Consider **sewer backflow preventer** valves if they are not currently part of the building's plumbing.

The installation should be done by a licensed plumber.

- If the current water heater is at, or below, the DFE, consider switching to a tankless water heater. A tankless water heater will take up less space and can be mounted to a wall due to its small size. In addition to allowing the user to mount it higher than a traditional water heater, it may also result in reduced energy costs.
- Older structures should consider elevation as a possible retrofit or mitigation opportunity. Older pre-FIRM structures can be at significant risk to flooding events. In coastal environments, even a little additional elevation can result in improved flood resistance. Costs can vary greatly depending on the type of foundation. It is important when considering an elevation project to consult a design professional before considering how much elevation and the appropriate foundation type. A contractor experienced with the elevation of buildings should be used for the actual lifting of the house. It is common for the house to require other structural work to the interior and exterior following the elevation. Before undertaking an elevation, consider the elevation process, which usually results in the structure being set on top of a foundation that is more level than the original foundation. This process can result in cosmetic cracking as the structure's foundation settles again and may require additional work to get the structure's aesthetics back to a pre-elevation appearance.

## Additional Resources

FEMA. 2010. *Substantial Improvement/Substantial Damage Desk Reference*. FEMA P-758. <http://www.fema.gov/library/viewRecord.do?id=4160>

FEMA. 2005. *Coastal Construction Manual*, Chapter 14. FEMA 55. (<http://www.fema.gov/library/viewRecord.do?id=1671>)

Florida Department of Community Affairs. 2000. *A Local Official's Guide to Implementing the National Flood Insurance Program in Florida*. (See Chapter 6). (<http://www.floridadisaster.org/Mitigation/NFIP/NFIPStudyCourse/Appendix%20E%20-%20FL%20Handbook.pdf>)

Developed in association with the National Association of Home Builders Research Center





# Repairs, Remodeling, Additions, and Retrofitting – Wind

**Purpose:** To outline requirements and “best practice” recommendations for repairs, remodeling, and additions, and propose opportunities for retrofitting in coastal high-wind areas.

## Key Issue

- Repairs and remodeling– either before or after storm damage– provide many opportunities for retrofitting homes and making them more resistant to storm damage (see Figure 1).

## Code Compliance

### Definitions from the International Code Council (ICC) Model Building Codes

**Addition:** An extension or increase in floor area or height of a building or structure.

**Alteration:** Any construction or renovation to an existing structure other than repair or addition that requires a permit. Also, a change in a mechanical system that involves an extension, addition, or change to the arrangement, type, or purpose of the original installation that requires a permit.

**Repair:** The reconstruction or renewal of any part of an existing building for the purpose of its maintenance.

### Factors That Determine Whether and How Existing Buildings Must Comply With Current Building Code Requirements

When undertaking repairs, remodeling, additions, or improvements to an existing building, there are two basic factors that determine whether and how the existing building must comply with building code requirements for new construction.

- **Value of damage/work**– whether the value of the building damage and/or work qualifies as substantial damage or substantial improvement under NFIP regulations (see text box).



**Figure 1. Storm-damaged homes need repairs, but also provide opportunities for renovation, additions, and retrofitting. Review substantial damage and substantial improvement regulations before undertaking any work.**

### International Residential Code (IRC) Requirements for Additions, Alterations or Repairs

**R102.7.1 Additions, alterations or repairs.** Additions, alterations, or repairs to any structure shall conform to the requirements for a new structure without requiring the existing structure to comply with all of the requirements of this code, unless otherwise stated. Additions, alterations, or repairs shall not cause an existing structure to become unsafe or adversely affect the performance of the building.



- **Nature of work**— whether the work involves an expansion of the building, either laterally or vertically (an addition), or the demolition and reconstruction of an existing building, or the relocation of an existing building.

Two other factors occasionally come into play (consult the authority having jurisdiction [AHJ] regarding whether and how these factors apply):

- **Code violations**— certain work to correct existing violations of state or local health, sanitary, or safety code requirements that have been cited by a code official may be excluded from calculations of value of work used to determine substantial improvement or substantial damage.
- **Historic structures**— work on a building that is on the National Register of Historic Places or that has been designated as historic by federally certified state or local historic preservation offices (or that is eligible for such designation) may be excluded from calculations of value of work used to determine substantial damage and substantial improvement requirements, provided such work does not cause the building to lose its historic designation.

## Substantial Damage and Substantial Improvement

It is not uncommon for existing coastal buildings to be modified or expanded over time, often in conjunction with the repair of storm damage. *All repairs, remodeling, improvements, additions, and retrofitting to buildings must be made in conformance with existing building code requirements pertaining to substantial improvement and substantial damage.*

### What Is Substantial Damage?

Substantial damage is damage, of any origin, where the cost to restore the building to its pre-damage condition equals or exceeds **50 percent of the building's market value before the damage occurred.**

### What Is Substantial Improvement?

Substantial improvement is any reconstruction, rehabilitation, addition, or improvement of a building, the cost of which equals or exceeds **50 percent of the building's pre-improvement market value.**

**When repairs and improvements are made at the same time,** all costs are totaled and compared with the 50 percent of market value threshold.

## What Costs Are Included in Substantial Damage and Substantial Improvement Determinations?

- All **structural items and major building components** (e.g., foundations; beams; trusses; sheathing; walls and partitions; floors; ceilings; roof covering; windows and doors; brick, stucco, and siding; attached decks and porches).
- **Interior finish elements** (e.g., tile, linoleum, stone, carpet; plumbing fixtures; gypsum wall-board and wall finishes; built-in cabinets, bookcases and furniture; hardware).
- **Utility and service equipment** (e.g., HVAC equipment; plumbing and wiring; light fixtures and ceiling fans; security systems; built-in appliances; water filtration and conditioning systems).
- Market value of **all labor and materials** for repairs, demolition, and improvements, including management, supervision, overhead, and profit (do not discount volunteer or self-labor or donated/discounted materials).

## What Costs Are Not Included in Substantial Damage and Substantial Improvement Determinations?

- **Design costs** (e.g., plans and specifications, surveys and permits).
- **Clean-up** (e.g., debris removal, transportation, and landfill costs).
- **Contents** (e.g., furniture, rugs, appliances not built in).
- **Outside improvements** (e.g., landscaping, irrigation systems, sidewalks and patios, fences, lighting, swimming pools and hot tubs, sheds, gazebos, detached garages).

**Note:** Some jurisdictions have enacted more restrictive requirements—some use a less-than-50-percent damage/improvement threshold. Some track the cumulative value of damage and improvements over time. Consult the AHJ for local requirements.

## Additions

Additions increase the square footage or external dimensions of a building. They can be divided into *lateral additions*, *vertical additions*, and *enclosures* of areas below *existing buildings*. When considering additions, it is important to consider that changes to the shape and roof line of the structure may impact the potential damages to the house. A lateral addition may change the number of openings, the way wind travels around the structure, or create a large open space that may require additional bracing.

Vertical additions may also impose greater loads on the existing structure. A qualified design professional should evaluate the loading to the entire structure to see if additional structural modifications are required in order to maintain the structure's ability to sustain high-wind loading.

### Lateral Additions

- If a *lateral addition* constitutes a *substantial improvement to a building*, both the addition and the existing building must comply with the current wind loading requirements. The foundation, walls, and roof may need to be altered in order to comply with wind loading requirements.

### Vertical Additions

- If a *vertical addition* to a building constitutes a substantial improvement, both the *addition and the existing building must comply* with the current wind loading requirements. The foundation, walls, and roof may need to be altered in order to comply with wind loading requirements. Vertical additions may apply significantly higher loadings to the foundation and first story, it is important to consider all of the framing and foundation modifications that need to be made (see Figure 2). Vertical additions may require the use of a geotechnical engineer and soil borings may be needed prior to design.

### Materials

When constructing in coastal environments, carefully consider what construction materials to select. For additional information, see Fact Sheet 1.7, *Coastal Building Materials*. Wind events can cause damage to several parts of the structure. Often the damage will consist of not only wind related damage, but also water intrusion. Following a storm event, repairs should not be started until the problem is properly evaluated and materials are selected that will entirely remedy the damage.

### Repairs

Correction of the apparent surface damage can lead to unaddressed or overlooked problems that can cause major issues with the structural stability of the building. Inspections often not only require demolition or removal of the physically damaged building component, but also removal of associated exterior cladding. Wind-driven rain can lead to compromised connections and decaying or rotting building materials that may not be visible without more investigation.

The repair of interior finishes damaged by wind-driven rain should be carefully considered. Coastal buildings are often subjected to high-wind events, which many times are accompanied by wind-driven rain. The wind pushes water through small openings in doors

and windows. This does not suggest improper functioning of the door or window, but this is more the result of the pressures these openings are subjected to during high-wind events. Interior surfaces such as walls, floor, and cabinets may be subjected to water on a regular basis. These building components may require finishes that will resist repeated water contact.

Repairs may present an excellent opportunity to upgrade the house. Additional connectors for maintaining a load path, additional moisture barriers, and installation of wind-resistant components are some possible options. The section on "Retrofit and Remodeling Opportunities" will outline some options to consider when undergoing repairs.



**Figure 2. Vertical addition to a home damaged by Hurricane Fran. Preexisting 1-story home became the second story of a home elevated to meet new foundation and floor elevation requirements.**

### Retrofit and Remodeling Opportunities

Retrofit opportunities will present themselves every time repair or maintenance work is undertaken for a major element of the building. Improvements to the building that are made to increase resistance to the effects of natural hazards should focus on those items that will potentially return the largest benefit to the building owner. For example:

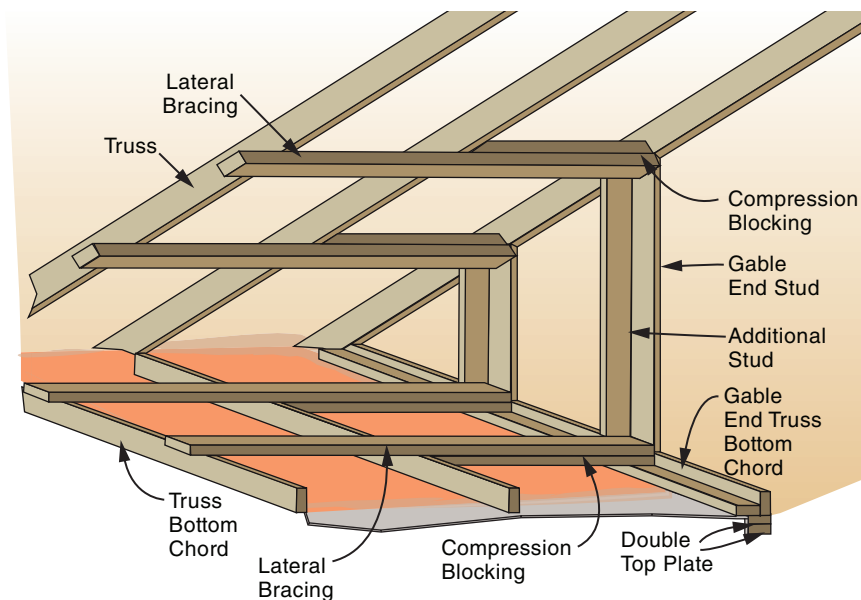
- When the **roof covering** is replaced, the attachment of the sheathing to the trusses or rafters can be checked, and additional load path connectors can be installed as necessary. The Technical Fact Sheets located in Category 7 of this publication provide details on how to improve the roof system's ability to resist wind and water intrusion. The common elements of a roof system should be carefully evaluated in order to address opportunities to improve the load path and water resistance of the system. The most common repair necessary following a storm event is the roof covering. When reroofing, tear-off is recommended instead of re-covering. Although some

jurisdictions allow for reroofing, this method may prevent the identification of more serious inadequacies in the system and result in more catastrophic failures in the next event. A roof covering project should be viewed as an opportunity to evaluate the strength of the roof sheathing. With the removal of the roof covering, a careful inspection of the sheathing should be conducted to look for darkened areas or areas subjected to water damage. If detected, these areas should be replaced. The thickness of the roof sheathing should be inspected to verify that it is of a sufficient thickness to resist the design wind speeds for your area. Also, consult the information in Fact Sheet 7.1, *Roof Sheathing Installation*, in order to improve roof system connections. Replacement of roof coverings also may provide opportunities to evaluate the adequacy of rafter or truss to wall system connections and install hurricane/seismic connectors. Information on these connections can be found in Fact Sheet 4.1, *Load Paths* and Fact Sheet 4.3, *Use of Connectors and Brackets*.

- If **siding** or **roof sheathing** has to be replaced, hurricane/seismic connectors can be installed at the rafter-to-wall or truss-to-wall connections, the exterior wall sheathing attachment can be checked, and structural sheathing can be added to shearwalls. Adding wall-to-foundation ties may also be possible. Verify that all exterior sheathing (wall and roof) is approved for use on exterior surfaces. Verify that fasteners are indeed connecting the exterior sheathing to the framing. See Fact Sheet 4.1, *Load Paths* and Fact Sheet 4.3, *Use of Connectors and Brackets* for additional information.

- **Gable ends** can be braced in conjunction with other retrofits or by themselves. The illustration in Figure 3 shows a typical gable end wall bracing system. These improvements are typically inexpensive, allow the loads imposed on the gable end walls to be distributed through multiple roof trusses or rafters, and assist in distributing the wind loads on the gable ends. Additional guidance for gable ends can be found in the *Gable End Retrofit Guide – Florida Division of Emergency Management*.
- Exterior **siding** attachment can be improved with more fasteners at the time the exterior is re-coated. See Fact Sheet 5.3, *Siding Installation in High-Wind Regions* for additional information.
- **Window, door, and skylight** reinforcement and attachment can be improved whenever they are accessible. Following a high-wind event, windows and doors should be checked for leaks. The framing should be checked for cracked paint or discolored paint. If the doors and windows are not shutting correctly, then this may indicate that the framing around the window or door suffered water damage. Check for worn areas where paint or caulking is missing and investigate for water damage or intrusion. Repair any water-damaged areas immediately. Framing should be inspected to verify that it is sufficiently attached to the wall system to provide sufficient protection. Improperly framed windows and doors have been found forced from their framing. See Fact Sheet 6.1, *Window and Door Installation* for additional information.
- When **windows** and **doors** are replaced, glazing and framing can be used that is impact-resistant and provides greater UV protection.

The windows and doors must meet wind-resistance standards and be installed in accordance with the manufacturer's installation instructions for high wind. Fasteners should be long enough to attach the window or door to wall framing around the opening. Fasteners should be spaced no greater than 16 inches unless otherwise stated by the manufacturer's recommended installation instructions. See Fact Sheet 6.2, *Protection of Openings—Shutters and Glazing*, for additional information on protecting openings. Verify that doors meet ASTM E330 and DASMA 108 and that windows meet ASTM E1886 and E1996 or Miami-Dade TAS 201, 202 and 203.



**Figure 3. Typical gable end wall bracing retrofit example.**



- **Soffits** should be inspected following high-wind events to determine whether structural upgrades are necessary. Soffit failures are common during storms and damage is often experienced in attics due to water being blown in through open soffits. Proper attachment is the most common problem noted with soffit failures. Wood backing or supports should be installed in order to provide a structural member to attach the soffit panels to. If it is not possible to install wood supports, the soffit should be secured at 12-inch intervals on each side in order to limit its ability to flex during high-wind events. See Fact Sheet 7.5, *Minimizing Water Intrusion through Roof Vents in High-Wind Regions* for additional information.
- Hurricane **shutters** can be added at any time (see Fact Sheet 6.2, *Protection of Openings–Shutters and Glazing*). Shutter systems should be purchased and installed well before a storm event. It is important to take the time necessary to verify that hangers and attachment systems are properly anchored to the structural system of the building. Shutter systems should be anchored to the building and maintain the load path of the building.
- **Floor-framing-to-beam connections** can be improved whenever they are accessible. See Fact Sheet 4.1, *Load Paths* and Fact Sheet 4.3, *Use of Connectors and Brackets* for additional information.
- **Beam-to-pile connections** can be improved whenever they are accessible. See Fact Sheet 3.3, *Wood Pile-to-Beam Connections* for additional information.
- At any time, deficient **metal connectors** should be replaced with stainless steel connectors or metal connectors with proper corrosion protection such as hot-dip galvanized steel. See Fact Sheet 1.7, *Coastal Building Materials* for additional information.
- When **HVAC equipment** is replaced, the replacement equipment should be more durable so that it will last longer in a coastal environment. It should also be elevated at, or above, the Base Flood Elevation (BFE) and adequately anchored to resist wind and seismic loads. See Fact Sheet 8.3, *Protecting Utilities* for additional information.
- **Utility attachment** can be improved when the outside equipment is replaced or relocated. See Fact Sheet 8.3, *Protecting Utilities* for additional information.
- In the **attic space**, at any time, *straps* should be added to rafters across the ridge beam, straps should be added from rafters to wall top plates, and gable end-wall framing should be braced. In addition, the uplift resistance of the roof sheathing can be increased through the application of APA AFG-01 or ASTM 3498 (see additional resources for more information) rated structural *adhesive* at the joints between the roof sheathing and roof rafters or trusses. The adhesive should be applied in a continuous bead and extended to the edges of the roof (where some of the highest uplift pressures occur). At the last rafter or truss at gable ends, where only one side of the joint is accessible, wood strips made of quarter-round molding may be embedded in the adhesive to increase the strength of the joint. For more information about the use of adhesive, see the “Additional Resources” section.
- The addition of **air admittance valves (AAV)** on all plumbing fixtures can reduce the need for roof penetrations required for conventional venting systems. The reduction in roof penetrations will reduce roof maintenance and reduce the number of openings available for water penetration. AAVs are not allowed in all jurisdictions, so verify with a licensed plumber that they are allowed in the jurisdiction where the house is being constructed.
- At any time, **garage doors** should be reinforced or replaced with new wind- and debris-resistant doors. There are some reinforcement kits available to provide both vertical and horizontal reinforcement of the garage door. If the garage door requires replacement, then select one that meets the design wind-speed requirements for your area. See Fact Sheet 6.2, *Protection of Openings–Shutters and Glazing*, for additional guidance on protecting openings and garage door guidance.
- To minimize the effects of corrosion, **metal light fixtures** can be replaced at any time with fixtures that have either wood or vinyl exteriors. However, wood may require frequent treatment or painting. See Fact Sheet 1.7, *Coastal Building Materials* for additional information.
- To minimize the effects of corrosion, carbon steel **handrails** can be replaced at any time with vinyl-coated, plastic, stainless steel, or wood handrails. Wood handrails may require frequent treatment or painting and appropriate fasteners must be used (see Fact Sheet 1.7, *Coastal Building Materials* for additional information). Carbon steel handrails may also be painted with a zinc-rich, vinyl, or epoxy paint appropriate for exposed wet and salt-spray environments. Regardless of the product used, proper maintenance is always necessary in order to ensure a safe handrail.

## Additional Resources

APA – The Engineered Wood Association, 2001, *APA Specification AFG-01*.

ASTM, *Standard Specification for Adhesives for Field-Gluing Plywood to Lumber Framing for Floor Systems*, 2003, ASTM 3498-03.

Clemson University, *Not Ready to Re-Roof? Use Structural Adhesives to Strengthen the Attachment of Roof Sheathing and Holding on to Your Roof* – A guide to retrofitting your roof sheathing using adhesives, Department of Civil Engineering and South Carolina Sea Grant Extension Program, ([http://www.haznet.org/haz\\_outreach/outreach\\_factsheets.htm](http://www.haznet.org/haz_outreach/outreach_factsheets.htm))

FEMA, *Substantial Improvement /Substantial Damage Desk Reference FEMA P-758*, 2010, (<http://www.fema.gov/library/viewRecord.do?id=4160>)

FEMA, *Coastal Construction Manual*, FEMA-55, 2005, (<http://www.fema.gov/library/viewRecord.do?id=1671>)

Florida Department of Community Affairs, *A Local Official's Guide to Implementing the National Flood Insurance Program in Florida*, 2000, (<http://www.floridadisaster.org/Mitigation/NFIP/NFIPStudyCourse/Appendix%20E%20-%20FL%20Handbook.pdf>)

Florida Division of Emergency Management, *Gable End Retrofit Guide*. (<http://www.floridadisaster.org/hrg>)

# References and Resources

**Purpose:** *To list references and resources that provide information relevant to topics covered by the Home Builder's Guide to Coastal Construction technical fact sheets.*

## References

A Dozen Things You Might Not Know That Make Vinyl Siding Green ([http://vinylsiding.org/greenpaper/090710\\_Latest\\_Revised\\_Green\\_paper.pdf](http://vinylsiding.org/greenpaper/090710_Latest_Revised_Green_paper.pdf))

American Concrete Institute. *ACI Detailing Manual*. SP-66(04). 2004. (<http://www.concrete.org>)

American Concrete Institute. *Building Code Requirements for Structural Concrete and Commentary*. ACI 318-02. (<http://www.concrete.org>)

American Concrete Institute. *Design, Manufacture, and Installation of Concrete Piles*. ACI 543R-00. Re-approved 2005. (<http://www.concrete.org>)

American Forest and Paper Association. *National Design Specification for Wood Construction*. (<http://www.afandpa.org>)

American Institute of Timber Construction. (<http://www.aitc-glulam.org>)

American Institutes for Research. *Evaluation of the National Flood Insurance Program's Building Standards*. 2006. (<http://www.fema.gov/library>)

American Iron and Steel Institute. *North American Specification for the Design of Cold-Formed Steel Structural Members*. AISI S100-07. 2007. (<http://www.steel.org>)

American National Standards Institute. *National Design Standard for Metal Plate Connected Wood Truss Construction*. ANSI/TPI-1 95.

American Society of Civil Engineers. *Minimum Design Loads for Buildings and Other Structures*. ASCE/SEI 7-05. (<http://www.asce.org>)

American Society of Civil Engineers. *Minimum Design Loads for Buildings and Other Structures*. ASCE/SEI 7-10. (<http://www.asce.org>)

American Society of Civil Engineers. *Flood Resistant Design and Construction*. ASCE/SEI 24-05. (<http://www.asce.org>)

American Society for Testing and Materials. *Standard Practice for Application of Self-Adhering Modified*

*Bituminous Waterproofing*. ASTM D6135-05. 2005. (<http://www.astm.org>)

American Society for Testing and Materials. *Standard Practice for Installation of Exterior Windows, Doors and Skylights*. ASTM E2112-07. (<http://www.astm.org>)

American Society for Testing and Materials. *Standard Specification for Round Timber Piles*. ASTM D25-99. 2005. (<http://www.astm.org>)

American Society for Testing and Materials. *Standard Specification for Adhesives for Field-Gluing Plywood to Lumber Framing for Floor Systems*. ASTM D3498-03. 2003. (<http://www.astm.org>)

American Society for Testing and Materials. *Standard Specification for Performance of Exterior Windows, Curtain Walls, Doors, and Impact Protective Systems Impacted by Windborne Debris in Hurricanes*. ASTM E1996-09. (<http://www.astm.org>)

American Society for Testing and Materials. *Standard Test Method for Performance of Exterior Windows, Curtain Walls, Doors, and Impact Protective Systems Impacted by Missile(s) and Exposed to Cyclic Pressure Differentials*. ASTM E1886-05. (<http://www.astm.org>)

American Society for Testing and Materials. *Standard Test Method for Structural Performance of Exterior Windows, Doors, Skylights and Curtain Walls by Uniform Static Air Pressure Difference*. ASTM E330-02. 2010. (<http://www.astm.org>)

American Forest Foundation, Inc. *American Tree Farm System*. (<http://www.treefarmssystem.org/index.shtml>)

American Wood Council. (<http://www.awc.org>)

American Wood Protection Association. *All Timber Products – Preservative Treatment by Pressure Processes*, AWPAC1-00; *Lumber, Timber, Bridge Ties and Mine Ties – Preservative Treatment by Pressure Processes*, AWPAC2-01; *Piles – Preservative Treatment by Pressure Process*, AWPAC3-99; and others. (<http://www.awpa.com>)

APA, The Engineered Wood Association. *APA Specification AFG-01*. 2001. (<http://www.apawood.org>)



APA, The Engineered Wood Association. *Hurricane Shutter Designs Set 5 of 5. Hurricane Shutter Designs for Woodframe and Masonry Buildings*. (<http://www.apawood.org>)

Brick Industry Association. (<http://www.gobrick.com>)

Clemson University, Department of Civil Engineering and South Carolina Sea Grant Extension Program. *Not Ready to Re-Roof? Use Structural Adhesives to Strengthen the Attachment of Roof Sheathing and Holding onto Your Roof – A Guide to Retrofitting Your Roof Sheathing Using Adhesives*. ([http://www.haznet.org/haz\\_outreach/outreach\\_factsheets.htm](http://www.haznet.org/haz_outreach/outreach_factsheets.htm))

Coastal Contractor Magazine. *Low Country Rx: Wet Floodproofing. Drainable, Dryable Assemblies Made With Water-tolerant Materials Help Speed Recovery From Deeper Than-expected Floods*, by Ted Cushman. July 2006. (<http://www.coastalcontractor.net/cgi-bin/issue.pl?issue=9>)

Concrete Reinforcing Steel Institute. *Placing Reinforcing Bars – Recommended Practices*. PRB-2-99. (<http://www.crsi.org>)

Copper and Common Sense. (<http://www.reverecopper.com>)

Copper Development Association. (<http://www.copper.org/publications>)

Door and Access Systems Manufacturers Association. *Standard Method for Testing Sectional Garage Doors and Rolling Doors: Determination of Structural Performance Under Uniform Static Air Pressure Difference*. ANSI/DASMA 108-2005.

FEMA. *Above the Flood: Elevating Your Floodprone House*. FEMA 347. 2000. (<http://www.fema.gov/library>)

FEMA. *Answers to Questions about Substantially Damaged Buildings*. FEMA 213. 1991. (<http://www.fema.gov/library>)

FEMA. *Coastal Construction Manual – Principles and Practices of Planning, Siting, Designing, Constructing, and Maintaining Residential Buildings in Coastal Areas*. FEMA 55. 2005. (Ordering information at: [http://www.fema.gov/pdf/plan/prevent/nhp/nhp\\_fema55.pdf](http://www.fema.gov/pdf/plan/prevent/nhp/nhp_fema55.pdf))

FEMA. *Design Guide for Improving Critical Facility Safety from Flooding and High Winds*. FEMA 543. 2007. (<http://www.fema.gov/library>)

FEMA. *Design Guide for Improving Hospital Safety in Earthquakes, Floods, and High Winds: Providing Protection to People and Buildings*. FEMA 577. 2007. (<http://www.fema.gov/library>)

FEMA. *Engineering Principles and Practices of Retrofitting Floodprone Residential Structures*. FEMA 259. January 1995. (<http://www.fema.gov/library>)

FEMA. *Flood Insurance Manual*. October 2010, January 2011. (<http://www.fema.gov/business/nfip/manual.shtml>)

FEMA. FloodSmart, the Official Site of the NFIP (<http://www.floodsmart.gov>)

FEMA. *Homebuilders' Guide to Earthquake Resistant Design and Construction*. FEMA 232. 2001. (<http://www.fema.gov/library>)

FEMA. *Homeowner's Guide to Retrofitting, Six Ways to Protect Your House From Flooding*. FEMA 312. 1998. (<http://www.fema.gov/library>)

FEMA. Map Service Center. (<http://www.msc.fema.gov>)

FEMA. *Mitigation Assessment Team Report, Hurricane Charley in Florida: Building Performance Observations, Recommendations, and Technical Guidance*. FEMA 488. 2005. (<http://www.fema.gov/library>)

FEMA. *Mitigation Assessment Team Report, Hurricane Ike in Texas and Louisiana: Building Performance Observations, Recommendations, and Technical Guidance*. FEMA P-757. 2009. (<http://www.fema.gov/library>)

FEMA. *Mitigation Assessment Team Report, Hurricane Ivan in Alabama and Florida: Building Performance Observations, Recommendations, and Technical Guidance*. FEMA 489. 2005. (<http://www.fema.gov/library>)

FEMA. *Mitigation Assessment Team Report, Hurricane Katrina in the Gulf Coast: Building Performance Observations, Recommendations, and Technical Guidance*. FEMA 549. 2006. (<http://www.fema.gov/library>)

FEMA. NFIP Elevation Certificate and Instructions. (<http://www.fema.gov/pdf/nfip/elvcert.pdf>)

FEMA. NFIP Forms. (<http://www.fema.gov/business/nfip/forms.shtml>)

FEMA. NFIP Technical Bulletin 1-08, *Openings in Foundation Walls and Walls of Enclosures*. 2008. (<http://www.fema.gov/plan/prevent/floodplain/techbul.shtml>)

FEMA. NFIP Technical Bulletin 2-08, *Flood Damage-Resistant Materials Requirements*. (<http://www.fema.gov/plan/prevent/floodplain/techbul.shtml>)

FEMA. NFIP Technical Bulletin 4-10, *Elevator Installation*. 2010. (<http://www.fema.gov/plan/prevent/floodplain/techbul.shtml>)

- FEMA. NFIP Technical Bulletin 5-08, *Free-of-Obstruction Requirements*. 2008. (<http://www.fema.gov/plan/prevent/floodplain/techbul.shtm>)
- FEMA. *NFIP Technical Bulletin 8-96, Corrosion Protection for Metal Connectors in Coastal Areas*. 1996. (<http://www.fema.gov/plan/prevent/floodplain/techbul.shtm>)
- FEMA. NFIP Technical Bulletin 9-08, *Design and Construction Guidance for Breakaway Walls*. 2008. (<http://www.fema.gov/plan/prevent/floodplain/techbul.shtm>)
- FEMA. NFIP Technical Bulletin 10-01, *Ensuring that Structures Built on Fill In or Near Special Flood Hazard Areas are Reasonably Safe From Flooding*. 2001. (<http://www.fema.gov/plan/prevent/floodplain/techbul.shtm>)
- FEMA. NFIP Technical Bulletin 11-01, *Crawlspace Construction*. 2001. (<http://www.fema.gov/plan/prevent/floodplain/techbul.shtm>)
- FEMA. *Protecting Building Utilities From Flood Damage*. FEMA 348. 1999. (<http://www.fema.gov/library>)
- FEMA. *Protecting Manufactured Homes from Floods and Other Hazards*. FEMA P-85. 2009. (<http://www.fema.gov/library>)
- FEMA. *Recommended Residential Construction for the Gulf Coast, Building on Strong and Safe Foundations*. FEMA 550. 2010. (<http://www.fema.gov/library>)
- FEMA. *Reducing Flood Losses Through the International Code Series*. 2006 I-Codes with 2007 Supplement. (<http://www.fema.gov/library>)
- FEMA. *Substantial Improvement/Substantial Damage Desk Reference*. FEMA P-758. 2010. (<http://www.fema.gov/library>)
- Florida Department of Community Affairs. *A Local Official's Guide to Implementing the National Flood Insurance Program in Florida*. 2000. (<http://www.floridadisaster.org/Mitigation/NFIP/NFIPStudyCourse/Appendix%20E%20-%20FL%20Handbook.pdf>)
- Florida Division of Emergency Management. *Hurricane Retrofit Guide*. (<http://www.floridadisaster.org/hrg>)
- Florida Roofing, Sheet Metal and Air Conditioning Contractor's Association, Inc. *Concrete and Clay Roof Tile Installation Manual*. (<http://www.floridarroof.com>)
- Forest Stewardship Council. (<http://www.fsc-info.org>)
- Information about product testing and approval process for Miami-Dade County, Florida. (<http://www.miamidade.gov/BuildingCode/home.asp>)
- International Code Council. *International Building Code*. 2009. (<http://www.iccsafe.org>)
- International Code Council. *International Residential Code*. 2009. (<http://www.iccsafe.org>)
- International Code Council Evaluation Service, Inc., *Protocol for Testing the Flood Resistance of Materials*. (<http://www.icc-es.org/index.shtml>)
- International Organization of Standards. Document ISO 14021. (<http://www.iso.org>)
- LSU AgCenter. *Wet Floodproofing. Reducing Damage from Floods*. Publication 2771. 1999. (<http://www.lsuagcenter.com/NR/rdonlyres/B2B6CDEC-2B58-472E-BBD9-0BDEB0B29C4A/26120/pub2771Wet6.pdf>)
- Metal Building Manufacturers Association. *Metal Roofing Systems Design Manual*. 2000. (<http://www.mbma.com/display.cfm?p=44&pp6&i=47>)
- Metal Construction Association. (<http://www.metalconstruction.org/pubs>)
- National Roofing Contractors Association. *The NRCA Waterproofing Manual*. (<http://www.nrca.net>)
- National Fire Protection Association. *Model Manufactured Home Installation Standard*. NFPA 225. 2009. ([http://www.nfpa.org/aboutthecodes/About-TheCodes.asp?DocNum=225&cookie\\_test=1](http://www.nfpa.org/aboutthecodes/About-TheCodes.asp?DocNum=225&cookie_test=1))
- National Institute of Building Sciences. *Whole Building Design Guide*. ([http://www.wbdg.org/design/env\\_roofing.php](http://www.wbdg.org/design/env_roofing.php))
- National Roofing Contractors Association. *The NRCA Roofing Manual: Metal Panel and SPF Roof Systems*. 2008. (<http://www.nrca.net/rp/technical/manual/default.aspx>)
- Pile Buck, Inc. *Coastal Construction*. (<http://www.pilebuck.com>)
- Professional Roofing. *NRCA Analyzes and Tests Metal*, by James R. Kirby and Bala Sockalingam. 2003. (<http://www.professionalroofing.net/article.aspx?id=266>)
- The Journal of Light Construction. (<http://www.jlconline.com>)
- The Masonry Society. *Building Code Requirements for Masonry Structures*. TMS 402-08/ACI 530-08/ASCE 5-08. 2008. (<http://www.masonrysociety.org>)
- The Masonry Society. *Specifications for Masonry Structures*. TMS 402-08/ACI 530.1 08/ASCE 6-08. 2008. (<http://www.masonrysociety.org>)

Sheet Metal and Air Conditioning Contractors National Association. *Architectural Sheet Metal Manual*. 2003. (<http://www.smacna.org/bookstore>)

Siding with the Environment ([http://www.vinylsiding.org/publications/final\\_Enviro\\_single\\_pg.pdf](http://www.vinylsiding.org/publications/final_Enviro_single_pg.pdf)). Southern Pine Council. (<http://www.southernpine.com/about.shtml>)

SFI Inc. Sustainable Forestry Initiative.® (<http://www.sfiprogram.org>)

Technical Notes 28 – Anchored Brick Veneer, Wood Frame Construction

Technical Notes 28B – Brick Veneer/Steel Stud Walls

Technical Notes 44B – Wall Ties

Timber Pile Council, American Wood Preservers Institute. *Timber Pile Design and Construction Manual*. (<http://www.wwpinstitute.org/pdffiles/TimberPile-Manual.pdf>)

U.S. Department of Housing and Urban Development. *Durability by Design, A Guide for Residential Builders and Designers*. 2002. (<http://www.huduser.org/publications/destech/durdesign.html>)

Vinyl Siding Institute. (<http://www.vinylsiding.org>)

*Developed in association with the National Association of Home Builders Research Center*





