



Safe Rooms for Tornadoes and Hurricanes

Guidance for Community and Residential Safe Rooms

FEMA P-361, November 2024

Fifth Edition



FEMA

Safe Rooms for Tornadoes and Hurricanes

Guidance for Community and Residential Safe Rooms

FEMA P-361, November 2024
Fifth Edition



FEMA

Any opinions, findings, conclusions, or recommendations expressed in this publication do not necessarily reflect the views of FEMA. Additionally, neither FEMA nor any of its employees makes any warrantee, expressed or implied, or assumes any legal liability or responsibility for the accuracy, completeness, or usefulness of any information, product, or process included in this publication. Users of information contained in this publication assume all liability arising from such use.

All documents were prepared with accessibility and compliance with Section 508 of the Rehabilitation Act of 1973 in mind. For further information or clarification regarding items such as technical drawings or maps, please contact the FEMA Building Science Helpline at FEMA-BuildingScienceHelp@fema.dhs.gov or 866-927-2104.

Copyright information:

All illustrations in this document were created by FEMA or a FEMA contractor unless otherwise noted. All photographs in this document are public domain or taken by FEMA or a FEMA contractor, unless otherwise noted.

Sections 101.1, 101.2, 106.2, 110.1, 111.1.2.1, 302.1, 304.1, 304.2, 304.3, 304.9, 305.1, 305.1.1, 306.4.1, 402.1, 402.5, 402.6.1, 402.6.2, 402.6.4, 402.6.3, 603.1, 702.5.2, and Figure 304.2(1), 304.2(2), 304.2(3), 305.2.2 are copyrighted materials excerpted from the 2023 ANSI/ICC 500, *ICC/NSSA Standard for the Design and Construction of Storm Shelters*. Copyright © 2023. International Code Council, Inc. All rights reserved. Reproduced with permission. www.ICCSAFE.org. Material noted as “USED WITH ASCE PERMISSION” may be downloaded for personal use only. Any other use requires prior permission of the American Society of Civil Engineers. This material may be found at <https://ascelibrary.org/doi/book/10.1061/9780784415788>.

Preface

Federal Emergency Management Agency (FEMA) publications presenting design and construction guidance for both residential and community safe rooms have been available since 1998. Since that time, tens of thousands of safe rooms have been built, and a growing number of these safe rooms have already saved lives in actual events. There has not been a single reported failure of a safe room constructed to FEMA criteria.

Nevertheless, FEMA continues to modify its guidance to proactively capture lessons learned from numerous post-disaster safe room and storm shelter performance assessments. Furthermore, this 2024 edition of FEMA P-361 is based on the 2023 update to the consensus standard from the International Code Council® (ICC®) and the National Storm Shelter Association® (NSSA®), the *ICC/NSSA Standard for the Design and Construction of Storm Shelters (ICC 500-2023)*.

FEMA P-361 (2024) presents updated and refined criteria for safe rooms compared to the previous edition's criteria, which were based on ICC 500-2020. The criteria presented in this publication address how to design and construct a safe room that provides near-absolute protection from wind and wind-borne debris for occupants.

FEMA continues to support the development of consensus codes and standards that establish minimum acceptable requirements for the design and construction of hazard-resistant buildings. FEMA also supported and participated in the development of the original 2008 edition of ICC 500, the 2014 edition, the 2020, and now the 2023 edition. Although the ICC 500 standard development committee used much of what was presented in the first edition of FEMA P-361 as a starting point for ICC 500, some differences remain between the two documents. Any differences between the ICC 500 criteria for storm shelters and FEMA Funding Criteria for safe rooms are identified at the beginning of Part B chapters in this publication. There are also differences in scope; for example, FEMA P-361 includes emergency management considerations and risk assessment guidance that are beyond the scope of ICC 500.

When safe room designers, operators, and emergency managers implement FEMA's safe room guidance in their projects, they can feel confident that they are using the best available information to guide the design and construction of a safe room (public or private) that provides near-absolute protection from the deadly winds and wind-borne debris associated with extreme-wind events. Additionally, if the safe room is being constructed with FEMA grant funds, adherence to the FEMA Funding Criteria described in Part B of this publication is required. FEMA Funding Criteria are those for which the requirements of FEMA P-361 are more stringent than ICC 500.

Table of Contents

Introduction to FEMA P-361	1
Chapter A1 Purpose and Background	A1-1
A1.1 Purpose	A1-2
A1.2 Safe Room and Sheltering Terminology	A1-3
A1.2.1 Summary of Sheltering Terminology	A1-5
A1.3 Background on FEMA Safe Room Design History and International Code Council Development of ICC 500	A1-6
A1.3.1 Development of FEMA Safe Room Guidance	A1-6
A1.3.2 Development of ICC 500	A1-7
A1.3.3 ICC 500-2023 Comparison with FEMA P-361 (2024)	A1-8
A1.3.4 FEMA Safe Room Grant Funding Program	A1-9
A1.4 Deciding Whether to Install or Construct a Safe Room	A1-10
Chapter A2 Extreme-Wind Risk Assessment and Analysis	A2-1
A2.1 Risk Assessment	A2-2
A2.1.1 Assessing Threat	A2-2
A2.1.2 Assessing Vulnerability	A2-12
A2.2 Project Planning	A2-19
A2.3 Summary of Protection Options for High-Wind Events	A2-19
Chapter A3 Safe Room Economic Considerations and Benefit-Cost Analysis	A3-1
A3.1 Design- and Location-Based Economic Considerations	A3-1
A3.1.1 Design-Based Economic Considerations	A3-1
A3.1.2 Location-Based Economic Considerations	A3-5
A3.2 Benefit-Cost Analysis	A3-7
A3.2.1 Safe Room Benefit-Cost Analysis Software	A3-7
A3.2.2 Determining Project Benefits	A3-7
Chapter A4 Operations and Maintenance Considerations for Community Safe Rooms	A4-1
A4.1 Safe Room O&M Plan Objectives and Parameters	A4-3
A4.1.1 Safe Room Design	A4-4

A4.1.2	Multi-use versus Single Use.....	A4-4
A4.1.3	Duration of Occupancy.....	A4-5
A4.1.4	Intended Occupants	A4-5
A4.2	Staffing and Personnel Considerations	A4-7
A4.2.1	Roles and Responsibilities.....	A4-8
A4.2.2	Contact Lists	A4-8
A4.2.3	Staff Training	A4-9
A4.2.4	Work Shifts.....	A4-11
A4.3	Community Outreach and Notification.....	A4-11
A4.3.1	Identifying Potential Safe Room Occupant Population and Providing Information	A4-11
A4.3.2	Signage	A4-13
A4.3.3	Expectation of Safe Room Use during Off Hours.....	A4-14
A4.3.4	Information on the Special Accommodation Needs of Potential Safe Room Occupants	A4-15
A4.3.5	Alert Signals and Drills	A4-15
A4.3.6	Pets.....	A4-16
A4.4	Emergency Provisions.....	A4-17
A4.4.1	Food and Water	A4-17
A4.4.2	Communications Equipment	A4-17
A4.4.3	Emergency Supplies.....	A4-18
A4.5	Access and Entry	A4-18
A4.5.1	Parking	A4-19
A4.5.2	Entering the Safe Room	A4-19
A4.5.3	Registering Occupants	A4-20
A4.5.4	Locking Down the Safe Room.....	A4-20
A4.6	Operations during an Event.....	A4-21
A4.6.1	Security	A4-21
A4.6.2	First Aid and Health Services.....	A4-22
A4.6.3	Communication	A4-22
A4.6.4	Fire Safety.....	A4-23
A4.7	Post-Event Operations	A4-23
A4.8	Maintenance	A4-24

List of Figures

Figure A1-1: Safe room decision-making flowchart	A1-12
Figure A2-1: Typical tornado damage descriptions to one- and two-family dwellings and their corresponding intensity according to the EF Scale.....	A2-5
Figure A2-2: Recorded EF3, EF4, and EF5 tornadoes in the contiguous United States from 1950 through 2022. Tracks illustrate path lengths, frequencies, and locations of extreme tornadoes; however, the widths of the track lines are greater than the widths of the areas prone to damaging winds (are not to scale)	A2-6
Figure A2-3: Basic wind speeds for Risk Category II buildings and other structures	A2-8
Figure A2-4: Typical hurricane damage descriptions to one-and two-family dwellings and thier corresponding intensity accordig to the Saffir Simpson Hurricane Wind Scale	A2-9
Figure A2-5: Major hurricane eye tracks along the United States and its territories from 1950 through 2022 providing an overview of the number and location of hurricane strikes with an inset demonstrating the large area impacted by a single event (Hurricane Michael; preliminary peak wind swath plot of estimated 3-second gust wind speed in mph at a height of 33 feet above ground, Exposure C [solid lines; ASCE 7-10 was the referenced standard by the 6 th Edition Florida Building Code in place at the time of landfall with its contours shown as dashed lines])	A2-11
Figure A3-1: The addition to this school was designed to serve as a multi-use safe room; it is also used as a cafeteria, gym, and large-group gathering space (Climax Springs, Missouri).....	A3-2
Figure A4-1: Example of a multi-purpose safe room also used as a gymnasium	A4-4
Figure A4-2: Example of a tornado protection zone map for a safe room intended to serve a specific protection (or intended occupant) zone	A4-13
Figure A4-3: Example of a sign showing location for safe room entrance	A4-14
Figure A4-4: Example of a site plan clearly identifying safe room access routes.....	A4-16
Figure A4-5: Interior operated safe room shutters in a multi-purpose classroom/safe room. Image on left is normal usage; image on right shows shutters in "lock down" position where they are closed and latched	A4-20

List of Tables

Table A1-1: Sheltering Terminology Matrix.....	A1-5
Table A2-1: Approximate Equivalent Wind Speeds in ASCE 7-22 and Saffir-Simpson Hurricane Wind Scale.....	A2-10
Table A2-2: Comparison of Shelter Terminology.....	A2-20

Chapter B1	Application and Administration	B1-1
B1.1	Criteria	B1-1
B1.2	FEMA Additional Guidance	B1-1
B1.2.1	Occupancy Group Classifications for Single-use and Multi-use Safe Rooms (Reference: ICC 500 Sec 104)	B1-2
B1.2.2	Applicable Code (Reference: ICC 500 Sec 101 and 105)	B1-2
B1.2.3	Submittal Documents (Reference: ICC 500 Sec 106)	B1-5
B1.2.4	Quality Assurance Plan (Reference: ICC 500 Sec 107)	B1-6
B1.2.5	Peer Review (Reference: ICC 500 Sec 108)	B1-7
B1.2.6	Owner’s Responsibility (Reference: ICC 500 Sec 109)	B1-8
B1.2.7	Contractor’s statement of responsibility (Reference: ICC 500 Sec 110)	B1-8
B1.2.8	Special Inspections (Reference: ICC 500 Sec 111)	B1-9
B1.2.9	Structural Observations (Reference: ICC 500 Sec 112)	B1-10
B1.2.10	Evaluation, Maintenance, and Repairs (Reference: ICC 500 Sec 113)	B1-10
Chapter B2	Definitions	B2-1
Chapter B3	Structural Design and Testing Criteria	B3-1
B3.1	Criteria	B3-1
B3.2	FEMA Additional Guidance	B3-3
B3.2.1	FEMA Funding Criteria: Structural Design and Testing for Safe Rooms	B3-3
B3.2.2	General Approach to the Structural Design of Safe Rooms (Reference: ICC 500 Sec 301)	B3-4
B3.2.3	Load Combinations (Reference: ICC 500 Sec 302)	B3-8
B3.2.4	Non-wind Load Considerations (Reference: ICC 500 Sec 303)	B3-8
B3.2.5	Wind Loads and Design (Reference: ICC 500 Sec 304)	B3-10
B3.2.6	Debris Hazards (Reference: ICC 500 Sec 305)	B3-34
B3.2.7	Envelope Component Testing, Listing, and labeling (Reference: ICC Sec 306)	B3-41
Chapter B4	Siting	B3-1
B4.1	Criteria	B3-1
B4.2	FEMA Additional Guidance	B3-4
B4.2.1	FEMA Funding Criteria: Siting	B3-5
B4.2.2	General Siting Considerations	B3-7
B4.2.3	Flood Hazards (Reference: ICC 500 Sec 402)	B3-12

Chapter B5 Occupant Density, Entry, Accessibility, Egress, and Signage..... B5-1

B5.1 Criteria B5-1

B5.2 FEMA Additional Guidance B5-1

 B5.2.1 Occupant Density B5-2

 B5.2.2 Entry and Egress for Community Safe Rooms (Reference: ICC 500 Sec 504)..... B5-6

 B5.2.3 Entry and Egress for Residential Safe Room (Reference: ICC 500 Sec 505)..... B5-10

 B5.2.4 Vertical Access and Egress (Reference: ICC 500 Sec 506)..... B5-11

 B5.2.5 Latching (Reference: ICC 500 Sec 507) B5-11

 B5.2.6 Signage for Safe Rooms (Reference: ICC 500 Sec 508) B5-12

Chapter B6 Fire Safety..... B6-1

B6.1 Criteria B6-1

B6.2 FEMA Additional Guidance B6-3

 B6.2.1 FEMA Funding Criteria: Safe Room Fire Safety B6-3

 B6.2.2 Fire Protection Systems (Reference: ICC 500 Sec 602)..... B6-4

 B6.2.3 Fire-Resistance-Rated Construction (Reference: ICC 500 Sec 603) B6-5

 B6.2.4 Fire Extinguishers (Reference: ICC 500 Sec 604)..... B6-6

Chapter B7 Essential Features and Accessories B7-1

B7.1 Criteria B7-1

B7.2 FEMA Additional Guidance B7-3

 B7.2.1 FEMA Funding criteria: safe room essential features and accessories..... B7-3

 B7.2.2 Protection of Critical Support Systems (Reference: ICC 500 Sec 702.2 and 703.2)..... B7-4

 B7.2.3 Water Closets and Lavatories (Reference: ICC 500 Sec 702.4 and 703.4) . B7-5

 B7.2.4 Drinking Water (Reference: ICC 500 Sec 703.5) B7-7

 B7.2.5 Rainwater Drainage (Reference: ICC 500 Sec 703.6)..... B7-8

 B7.2.6 Ventilation (Reference: ICC 500 Sec 702.5 and 703.7) B7-8

 B7.2.7 Standby Power (Reference: ICC 500 Sec 702.9 and 703.11)..... B7-10

 B7.2.8 Standby Lighting (Reference: ICC 500 Sec 702.8 and 703.10) B7-11

 B7.2.9 First Aid Kits (Reference: ICC 500 Sec 702.10 and 703.12)..... B7-12

Chapter B8 Test Methods for Impact and Pressure Testing..... B8-1

B8.1 Criteria B8-1

B8.2	FEMA Additional Guidance	B8-1
B8.2.1	Wind-borne Debris in Tornadoes and Hurricanes	B8-1
B8.2.2	Representative Missiles for Debris Impact Testing.....	B8-6
B8.2.3	Performance of Wall and Roof Assemblies During Tornado Missile Impact Tests	B8-11
B8.2.4	Debris Impact and Pressure Testing Criteria for Impact-Protective Systems.....	B8-18

Chapter B9 References and Resources B9-1

B9.1	Storm Surge Inundation Data.....	B9-7
------	----------------------------------	------

List of Figures

Figure B3-1:	Safe room design tornado speed zones	B3-12
Figure B3-2:	Safe room design wind speeds for hurricanes	B3-13
Figure B3-3:	Safe room design wind speeds for Alaska	B3-14
Figure B3-4:	Comparison of tributary and effective wind areas for a roof supported by open-web steel joists	B3-27
Figure B3-5:	MWFRS combined loads and C&C loads acting on a safe room wall section	B3-28
Figure B3-6:	Critical connections important for providing a continuous load path in a typical masonry, concrete, or metal-frame building wall (for clarity, concrete roof deck is not shown).....	B3-30
Figure B3-7:	Continuous load path in a reinforced masonry building with a concrete roof deck...B3-31	
Figure B3-8:	Failure of load path between the bond beam and the top of the unreinforced masonry wall when struck by an F4 tornado (Moore, Oklahoma 1999 tornado).....	B3-32
Figure B3-9:	Bolt failure at interior column resulting from shear and tension. The hooked anchor bolts pulled out of the slab (red arrow) (Joplin, Missouri 2011 tornado).....	B3-34
Figure B3-10:	View of a community shelter that is partially below grade (Wichita, Kansas, 1999 tornado)	B3-37
Figure B3-11:	Soil cover over a safe room relieving the requirement for debris impact resistance	B3-37
Figure B3-12:	Falling debris fall radius. Left image shows example of where the safe room is sited within the falling debris hazard’s fall radius and impact loading is required. Right image shows where falling debris impact loading is not required.....	B3-39
Figure B3-13:	Laydown of communications tower onto a building (Rockport, Texas, 2017 hurricane)	B3-39
Figure B3-14:	Laydown of a large communications tower onto a building (Joplin, Missouri, 2011 tornado).....	B3-39
Figure B3-15:	Example of falling debris hazard: Brick veneer failure on church (Refugio, Texas, 2017 hurricane).....	B3-40
Figure B3-16:	Vehicle rollover (Greensburg, Kansas, 2007 tornado)	B3-41

Figure B3-17: Example door label for a product that has been tested to earlier safe room criteria.....	B3-42
Figure B3-18: Alcove entry system protected by a debris-resistant barrier (note that the safe room roof extends past the safe room wall and connects to the top of the debris-resistant barrier to prevent intrusion of debris traveling vertically)	B3-44
Figure B4-1: Example illustration of preferred, allowable, and restricted community safe room locations	B4-20
Figure B4-2: Example illustration of a typical riverine cross-section and perpendicular shoreline transect showing stillwater and wave crest elevations and associated flood zones for community safe room siting	B4-21
Figure B4-3: Illustration of community safe room examples that meet flood elevation criteria (assuming siting requirements are met)	B4-21
Figure B4-4: Example illustration of preferred, allowable, and restricted residential safe room locations	B4-23
Figure B4-5: Example illustration of a typical riverine cross section and perpendicular shoreline transect showing stillwater and wave crest elevations and associated flood zones for residential safe room siting	B4-23
Figure B4-6: Illustration of residential safe room examples that meet flood elevation criteria (assuming siting requirements are met)	B4-24
Figure B5-1: Safe room entry sign examples	B5-13
Figure B8-1: Medium debris: Pieces of a built-up roof from Hurricane Katrina (MS, 2005)	B8-2
Figure B8-2: Medium debris: The double 2x6 framing member (red arrow) sticking 13 feet out of the roof penetrated a ballasted ethylene propylene diene monomer (EPDM) roof membrane, 3 inches of polyisocyanurate insulation, and a steel roof deck. The yellow dashed arrow indicates a 16-foot-long 2x10. (Moore, Oklahoma, 1999 tornado).....	B8-3
Figure B8-3: Large debris: Steel beam that blew into a school (Greensburg, Kansas, 2007 tornado).....	B8-3
Figure B8-4: Large debris: Steel roof trusses that blew off a school (U.S. Virgin Islands, 1995 Hurricane Marilyn)	B8-4
Figure B8-5: Large debris: An EF1 tornado blew a school gymnasium’s steel truss and steel deck roof assembly approximately 230 feet (Cleveland, Tennessee, 2011)	B8-4
Figure B8-6: Large debris: Propane tank that was blown from its original location (Midwest tornadoes, 2007).....	B8-5
Figure B8-7: Large debris: A school bus was lifted atop a school (Caledonia, Mississippi, tornado, 2008).....	B8-5
Figure B8-8: Representative quantity, size, and type of debris that is often generated by a strong or violent tornado. The building damage at this site was indicative of an EF3 tornado. (Greensburg, Kansas, 2007).....	B8-6
Figure B8-9: Refrigerator pierced by a 2x6. The portion of the 2x6 that is visible was 4 feet 8 inches long. It went several inches into the freezer compartment. (Oklahoma City, Oklahoma, 1999 tornado).....	B8-8

Figure B8-10: Impact of structural wood members in the gable end from a neighboring house (Pine Island, Florida).....	B8-11
Figure B8-11: Impact test locations for a panel or framed roof or wall assembly.....	B8-12
Figure B8-12: Use of steel sheet metal in wall assemblies	B8-14
Figure B8-13: CMU wall assemblies	B8-14
Figure B8-14: Steel porch column debris from an apartment complex where columns that were 7 feet 9 inches long and 4¼ inches in diameter (see red arrows) had a significant upward trajectory and flew approximately 230 feet (Tuscaloosa, Alabama, 2011 tornado)	B8-16
Figure B8-15: Steel beam debris (Greensburg, Kansas, 2007 tornado)	B8-16
Figure B8-16: Reinforced concrete wall [a] and reinforced concrete “flat” wall constructed with ICFs [b].....	B8-17
Figure B8-17: Red arrows show a steel tube that perforated a waffle grid ICF wall. Inset shows the tube in the “as found” condition and main photograph shows the tube after it was partially pulled out of the wall. (Moore, Oklahoma, 2013 tornado).....	B8-17
Figure B8-18: This metal door was damaged by wind-borne debris generated by a weak tornado. The bottom hinge was damaged, but the single latch was able to resist the modest wind and impact load. The door was on the verge of failing. (St. Louis, Missouri, 2013 tornado)	B8-20

List of Tables

Table B1-1: Comparison of ICC 500 Requirements to FEMA Funding Criteria	B1-1
Table B3-1: Comparison of ICC 500 Requirements to FEMA Funding Criteria	B3-1
Table B3-2: Tornado Frequencies in the United States (1950–2006)	B3-15
Table B3-3: Tornado Missile Impact Criteria	B3-35
Table B3-4: Hurricane Missile Impact Criteria	B3-36
Table B3-5: Residential FEMA-Funded Safe Room Test Missile Impact Criteria	B3-36
Table B4-1: Comparison of ICC 500 Requirements to FEMA Funding Criteria	B4-1
Table B5-1: Occupant Density for Community Tornado Safe Rooms	B5-3
Table B5-2: Occupant Density for Community Hurricane Safe Rooms	B5-4
Table B5-3: Occupant Density for Residential Safe Rooms	B5-6
Table B6-1: Comparison of ICC 500 Requirements to FEMA Funding Criteria	B6-2
Table B7-1: Comparison of ICC 500 Requirements to FEMA Funding Criteria	B7-2
Table B8-1: Wind-Borne Debris Classifications for Tornadoes and Hurricanes.....	B8-1

List of Appendices

Appendix A: Acronyms

Appendix B: Acknowledgments

Appendix C: Designer Checklist

Appendix D: Comparison Matrix of Differences between ICC 500 Requirements and
FEMA Funding Criteria

Introduction to FEMA P-361

This publication provides guidance from the Federal Emergency Management Agency (FEMA) about the planning, design, construction, and operation of safe rooms. It presents important information about the design and construction of residential and community safe rooms that will protect people during extreme-wind events such as tornadoes and hurricanes.

The guidance in FEMA P-361 is intended for architects, engineers, building officials, local officials, emergency managers, various planners, and safe room owners and operators. FEMA P-361 was first published in 2000, with updated editions in 2008, 2015, and 2021.

Since the 2021 edition of FEMA P-361 was published, several significant tornado and hurricane events have occurred, considerable research has been conducted, and the International Code Council® (ICC®) has updated the consensus standard that codifies the design and construction requirements of storm shelters. This standard, the *ICC/NSSA Standard for the Design and Construction of Storm Shelters*, is known as ICC 500 and was produced by ICC in cooperation with the National Storm Shelter Association® (NSSA®). The 2000 edition of FEMA P-361 served as a foundational document for the development of ICC 500. ICC 500 was completed in 2008, updated in 2014 and 2020, and most recently updated in 2023. This edition of FEMA P-361 uses ICC 500-2023 both as a companion and reference document.¹

This edition of FEMA P-361 is presented in two parts: Part A and Part B.

Part A Content and Organization

Part A presents information that safe room designers, owners, and emergency management officials may find useful in planning, designing, and operating a safe room. Information includes FEMA’s guidance and recommendations related to safe room design and construction oversight, risk assessment and analysis, costs, and Benefit-Cost Analysis (BCA); also included are operations and maintenance (O&M) considerations for community safe rooms. Specific content consists of the following topics:

- Purpose and Background (Chapter A1)

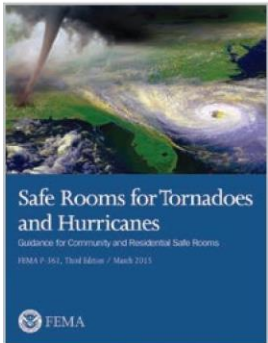
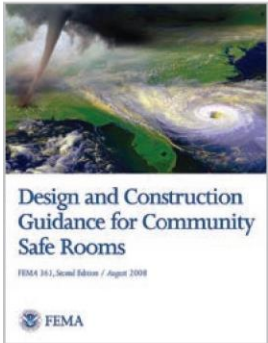
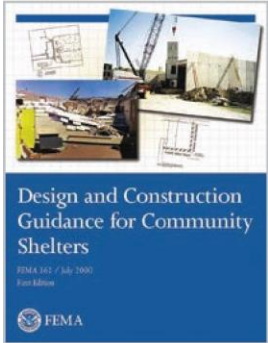

¹ ICC 500 is an American National Standard approved by the American National Standards Institute (ANSI). The current edition is formally titled 2023 ANSI/ICC 500, *ICC/NSSA Standard for the Design and Construction of Storm Shelters*, but is referred to throughout this document as ICC 500.

- Extreme-Wind Risk Assessment and Analysis (Chapter A2)
- Safe Room Economic Considerations and Benefit-Cost Analysis (Chapter A3)
- Operations and Maintenance Considerations for Community Safe Rooms (Chapter A4)

NOTE

Part A Intended Audience

Part A is geared towards designers, building owners and operators, building officials, various planners, and emergency managers. It contains information on planning, designing, and operating a safe room.

Part B Content and Organization

Part B consists of eight chapters that correspond to the chapters of ICC 500-2023, the referenced standard for each topic area. Each chapter presents FEMA Funding Criteria if differences with ICC 500 have been identified or notes that no additional FEMA Funding Criteria are required for FEMA-funded safe rooms. FEMA guidance on the chapter's topic area follows the criteria specifications. Details on FEMA Funding Criteria are provided below.

NOTE

Part B Intended Audience

Part B is geared towards safe room designers, various planners, and FEMA grant stakeholders. Its eight chapters correspond to the chapters of ICC 500-2023. Each chapter in Part B identifies any differences between FEMA Funding Criteria and ICC 500 requirements. All safe rooms constructed with FEMA grant funds must adhere to the "FEMA-Funding Criteria" described in Part B of FEMA P-361, which are more conservative than the corresponding ICC 500 requirements.

FEMA Funding Criteria and Additional Guidance

Safe rooms should be designed and constructed in accordance with the provisions of ICC 500. In addition, FEMA P-361 provides FEMA Funding Criteria that are more conservative than code and standard minimum requirements. Based on field investigation and research, FEMA believes these Funding Criteria are necessary to provide near-absolute protection during extreme-wind events. Safe rooms constructed with FEMA grant funds are required to adhere to FEMA Funding Criteria, described at the beginning of Part B chapters, as well as the corresponding ICC 500 requirements.

Part B Chapters (aside from B2, Definitions) of this publication begin by describing any FEMA Funding Criteria that exceed the requirements found in the corresponding chapter of the 2023 version of ICC 500.

BEST PRACTICES

Best practices are identified throughout the publication with a “BEST PRACTICE” call-out and blue bolded and italic text.

The additional guidance provides important background information for implementing various provisions addressed in the corresponding chapter of ICC 500, where applicable. Also, the additional guidance details best practice considerations that are not listed as FEMA Funding Criteria and further explains listed criteria. Best practices are labeled throughout this publication and identified with blue bolded and italic blue. Implementing these best practices is ***not*** a requirement for receiving FEMA grant funding.

Organization

Part B includes the following chapters, which follow the nomenclature and general content of Chapters 1 through 8 of ICC 500:

- Application and Administration (Chapter B1)
- Definitions (Chapter B2)
- Structural Design and Testing Criteria (Chapter B3)
- Siting (Chapter B4)
- Occupant Density, Entry, Accessibility, Egress, and Signage (Chapter B5)
- Fire Safety (Chapter B6)
- Essential Features and Accessories (Chapter B7)
- Test Methods for Impact and Pressure Testing (Chapter B8)
- References and Resources (Chapter B9)

Appendices

Appendices include:

- Acronyms (Appendix A)
- Acknowledgments (Appendix B)
- Designer Checklist (Appendix C)
- Comparison Matrix of Differences between ICC 500 Requirements and FEMA Funding Criteria (Appendix D)

This page left blank intentionally

Part A

This page left blank intentionally

Chapter A1 Purpose and Background

Tornadoes and hurricanes are among some of the most destructive forces of nature. Unfortunately, these types of windstorms continue to cause injury and death to people who are unable to safely evacuate or find shelter from these events. FEMA has developed and provided design and construction guidance for safe rooms since the release of the first edition of FEMA P-320, *Taking Shelter from the Storm: Building a Safe Room for Your Home or Small Business*, in 1998. A safe room is a hardened structure specifically designed to meet FEMA criteria and provide life-safety protection in extreme-wind events, including tornadoes and hurricanes. In addition, FEMA supports efforts to incorporate the safe room and other hazard-resistant design and construction guidance into codes and standards. Specifically, FEMA has actively supported the development of the ICC's and NSSA's standard, ICC 500, *Standard for the Design and Construction of Storm Shelters*.

FEMA P-361, *Safe Rooms for Tornadoes and Hurricanes: Guidance for Community and Residential Safe Rooms* (2024), references much of the design criteria of the ICC 500-2023 with some exceptions. All of these exceptions are identified at the beginning of Chapters B1 through B8 in Part B and summarized in Table D-1 (Appendix D).

ICC 500 is referenced in each edition of the International Building Code® (IBC®) and International Residential Code® (IRC®) since 2009 and is, therefore, part of the building code (incorporated by reference) as a readily enforceable design standard. The best practices and FEMA Funding Criteria described in FEMA P-361 are guidance; they are not a code nor standard enforceable in a jurisdiction unless they have been adopted as a standard for tornado or hurricane safe rooms. However, to qualify for FEMA safe room grant funds, all FEMA Funding Criteria in FEMA P-361, summarized in Table D-1, must be met in addition to the requirements of ICC 500-2023. This publication supersedes all earlier versions of FEMA P-361, as well as the *FEMA National Performance Criteria for Tornado Shelters* (1999). See Section A1.2 for an explanation of shelter terminology.

NOTE Codes and Standards

ICC 500-2023 and the 2024 editions of the IBC and IRC are available from the following links:

<https://codes.iccsafe.org/content/ICC5002023P1>

<https://codes.iccsafe.org/content/IBC2024P1>

<https://codes.iccsafe.org/content/IRC2024P1>

The Devastation of Tornadoes

The National Weather Service (NWS) did not start keeping organized records of tornadoes in the United States until 1950. Since then, the deadliest year for tornadoes was 2011, which claimed 553 lives. The single deadliest tornado to date was in Joplin, Missouri, on May 22, 2011, with 161 fatalities.

Compared with hurricanes and earthquakes, single tornado events typically affect smaller geographical areas but occur more often and cause more deaths.



This photograph, taken by FEMA in May 2013, in Moore, Oklahoma, shows the vivid reality of how lives are impacted by tornadoes.

A1.1 Purpose

The primary purpose of FEMA P-361 is to provide guidance on the design, construction, and operation of community and residential safe rooms, as well as FEMA Funding Criteria and best practices. Specifically, this publication provides criteria and guidance for the design, construction, installation, and inspection of any safe room so that it is capable of providing near-absolute protection for its occupants during extreme-wind events such as tornadoes and hurricanes.

FEMA P-361 FEMA Funding Criteria

If safe rooms are constructed with FEMA funds, the design must comply with the FEMA Funding Criteria described in Part B of this publication as well as ICC 500. FEMA's criteria were developed to provide near-absolute protection for safe room occupants. Refer to the latest edition of the *Hazard Mitigation Assistance Program and Policy Guide (HMA Program and Policy Guide)* for the most current FEMA policy statement on safe room implementation. See <https://www.fema.gov/grants/mitigation/hazard-mitigation-assistance-guidance>.

The design and construction of FEMA-funded safe rooms must comply with:

- ICC 500 requirements

- FEMA Funding Criteria, all of which are identified at the beginning of Chapters B1 through B8 in Part B of this publication and summarized in Table D-1 (Appendix D)
- The Rehabilitation Act of 1973, as amended, including Section 504, Programs, Services and Activities (29 U.S.C. § 794); federal agencies and those receiving federal assistance must ensure that their programs are usable and accessible to persons with disabilities (see Section B5.2.2.1)

FEMA P-361 provides guidance on the planning and engineering issues for design and construction of stand-alone safe room buildings, constructing safe rooms within a new building, and adding a safe room to an existing building. The guidance in this publication builds on knowledge gained through field investigations and research, as represented in FEMA's technical reports and publications, as well as information from other national and state agencies and universities that have studied the performance of the built environment during tornadoes and hurricanes.

FEMA P-361 (2024) references ICC 500 requirements, but also identifies the specific technical criteria for which the FEMA grant funding requirements exceed the minimum requirements of ICC 500. This approach is consistent with past FEMA guidance publications. FEMA publications provide guidance and best practices that are above and beyond the minimum criteria and scope of the consensus codes and standards for design and construction of structures to resist natural and human-caused hazards. FEMA guidance publications also address emergency management considerations, which are often out of scope for codes and standards.

Some aspects of the planning necessary for very-high-capacity safe rooms that may be required in large, public venues such as stadiums or amphitheaters are beyond the scope of this publication. Although an owner or operator of such a venue should follow the applicable requirements presented in this publication, detailed guidance for operational aspects concerning very-high-capacity safe rooms is not provided. The design of such safe rooms requires attention to human factor engineering issues that affect the life safety for a concentration of a large number of people. Egress timing for thousands of people, how to manage a large group of individuals in a safe room, and security within a safe room are examples of human behavioral issues that should be addressed when protecting a large group of people.

A1.2 Safe Room and Sheltering Terminology

FEMA has developed specific terminology to differentiate types of extreme-wind refuge areas from other types of "shelters." An understanding of these specific terms and the historical guidance is important because the terms FEMA uses to describe sheltering options have slightly different meanings (see Table A1-1) and levels of protection.

The terms "safe room" and "storm shelter" have been used interchangeably in past publications, guidance documents, and other shelter-related materials. However, to distinguish between "storm shelters" and "safe rooms," use the following guidance:

- "**Storm shelters**" meet the requirements in the ICC 500 standard

- “**Safe rooms**” meet the requirements in the ICC 500 standard and the more stringent FEMA Funding Criteria for near-absolute protection in this publication. All safe room criteria in this publication meet or exceed the storm shelter requirements of ICC 500.

TERMINOLOGY

Near-absolute protection: Based on our current knowledge of tornadoes and hurricanes, the occupants of a safe room built according to this guidance will have a very high probability of being protected from injury or death.

Our knowledge of tornadoes and hurricanes is based on substantial meteorological records as well as extensive investigations of damage from extreme winds. However, extreme-wind events may occur or could have occurred in the past that exceed the maximum design criteria in this publication. Such events have not been observed. For this reason, the protection provided by these safe rooms is called near -absolute rather than absolute.

A lesser form of potential occupant protection may be provided by a “Best Available Refuge Area,” or BARA. The term BARA was developed to designate an area in an existing building that has been determined by a registered design professional (RDP) to be the area least vulnerable to the life-threatening effects of extreme wind and wind-borne debris associated with a tornado or hurricane. Regardless, because these areas were not specifically designed as safe rooms or storm shelters, their occupants may be injured or killed during an extreme-wind event.

Furthermore, the term “shelter” is used in different ways by different agencies and entities. For instance, the American Red Cross uses the term “shelter” to refer to temporary recovery areas.

This section describes additional background and subsets of safe room and sheltering terminology. Additional detail on the differences between ICC 500-2023 and FEMA P-361 (2024) can be found in Section A1.3.3.

Safe Rooms

A safe room is an interior room, a space within a building, or an entirely separate building, designed and constructed to provide near-absolute life-safety protection for its occupants from extreme-wind events such as tornadoes or hurricanes. Safe rooms are designed and constructed to meet the criteria in this publication, which all meet or exceed the criteria in ICC 500. Criteria for FEMA safe rooms, “FEMA Funding Criteria,” exceed ICC 500 criteria and must be met when FEMA funds are used to construct or install a safe room.

Storm Shelters

Storm shelters provide life-safety protection from extreme-wind events; they are designed and constructed to meet ICC 500 criteria, but do not have to meet the additional “Funding Criteria” in

FEMA P-361 to be considered a “safe room.” **All safe rooms are storm shelters, but not all storm shelters are safe rooms.**

Best Available Refuge Area (BARA)

The term “BARA” was developed to designate an area in an existing building that has been determined by an RDP to be the area least vulnerable to the life-threatening effects of extreme wind associated with a tornado or hurricane. It is a lesser form of occupant protection than a storm shelter or safe room. The existing building may or may not have been built to meet code. Regardless, because these areas were not specifically designed as safe rooms or storm shelters, their occupants may be injured or killed during an extreme-wind event. However, people in BARAs are potentially less likely to be injured or killed by the extreme-wind incident than people in other areas of that building(s). Please refer to Section A1.2 for more information on BARAs and hurricane shelter terminology.

Recovery Shelter

Additionally, the term “shelter” is used in different ways by different agencies and entities. For instance, the American Red Cross uses the term “shelter” to refer to temporary recovery areas.

A1.2.1 SUMMARY OF SHELTERING TERMINOLOGY

Table A1-1 summarizes sheltering terminology.

Table A1-1: Sheltering Terminology Matrix

	FEMA Safe Room	ICC 500 Storm Shelter	BARA	Recovery Shelter
Designed to minimum building code requirements	Yes	Yes	Maybe	Maybe
Determined by a registered design professional to be the building area least vulnerable to the life-threatening effects of extreme winds	N/A ^(a)	N/A ^(a)	Yes	No
Designed to provide life-safety protection per ICC 500	Yes	Yes	No	No
Designed to provide near-absolute protection per FEMA P-361 criteria (including operational and emergency planning criteria)	Yes	Maybe ^(b)	No	No
Intended for use following a high-wind event for people requiring temporary shelter as community recovery efforts begin	No	No	No	Yes

Notes:

(a) Safe room or storm shelter is building area least vulnerable to the life-threatening effects of extreme winds; determination by a registered design professional is unnecessary.

(b) Due to limited criteria differences between ICC 500 and FEMA P-361, some storm shelters may also qualify as safe rooms.

N/A = Not Applicable

In addition to the terminology presented in Table A1-1, there are other high-wind shelter types in use across the United States. Additional information on these types of shelters (which do not provide near-absolute protection against high-wind events) can be found in Section A2.3.

A1.3 Background on FEMA Safe Room Design History and International Code Council Development of ICC 500

The first edition of FEMA P-361, released in July 2000, set forth comprehensive design and construction criteria for tornado and hurricane shelters. These criteria were used as the basis for the design and construction of thousands of safe rooms funded by FEMA in communities across the Nation since 2000. The second edition, published in 2008, updated and expanded the recommendations by referencing much of the newly released ICC 500-2008. The third edition of FEMA P-361, published in 2015, continued to provide guidance for the design and construction of tornado and hurricane safe rooms and included updates to incorporate code and standard changes, including those to the 2015 IBC, 2015 IRC, American Society of Civil Engineers (ASCE) standard ASCE 7-10, *Minimum Design Loads for Buildings and Other Structures*, and ICC 500-2014, as well as lessons learned through post-disaster assessments since 2008. The fourth edition, referred to as FEMA P-361 (2021), was updated to incorporate code and standard changes to the 2018 and 2021 IBC, 2018 and 2021 IRC, 2018 and 2021 International Existing Building Code® (IEBC®), ASCE 7-16, *Minimum Design Loads and Associated Criteria for Buildings and Other Structures*, and ICC 500-2020. This 2024 edition of FEMA P-361 has undergone further revisions to incorporate updates pertaining to the 2024 IBC, IRC, IEBC, ASCE 7-22, and ICC 500-2023.

A1.3.1 DEVELOPMENT OF FEMA SAFE ROOM GUIDANCE

Post-event investigations have also shaped the standards and guidance for tornado storm shelters and safe rooms. The Lubbock, Texas, tornado in 1970, which caused 26 fatalities, over 1,500 injuries, and extensive property damage, prompted Texas Tech University's (TTU's) civil engineering department to investigate the event and pioneer field research investigations of subsequent tornados and hurricanes. TTU used the data from these investigations to develop strategies for designing and testing structures that would protect occupants. This began the groundwork for storm shelter design and testing.

FEMA also conducts post-windstorm assessments, which have shaped the development of FEMA P-361 and FEMA P-320, *Taking Shelter from the Storm: Building a Safe Room for Your Home* (2024). When a major windstorm results in a presidentially declared disaster of national significance in the United States or one of its territories, FEMA's Building Science Disaster Support Program may deploy a technical building sciences team, called a Mitigation Assessment Team (MAT). A MAT is generally deployed when FEMA believes the findings and recommendations derived from field observations will advance the understanding of damages to help improve design, construction, manufacturing, code enforcement, code and standard revisions, research, planning, mitigation, or any other key components for strengthening building, community, or community lifeline resilience. The objectives of these teams are to observe and assess the performance of buildings, evaluate design and construction practices, and evaluate building code requirements and enforcement among many

other potential factors, in light of the observed building performance. The MAT then develops recommendations for improving building performance in future events.

FEMA deployed a MAT following a tornado outbreak in Kansas and Oklahoma in May 1999 that caused 49 fatalities, approximately 800 injuries, and extensive property damage. This building performance assessment led to the development of the first edition of FEMA P-361, published in 2000. A year before the Kansas and Oklahoma outbreak, using the results of TTU's Wind Engineering Research Center, FEMA had published the first edition of FEMA P-320. This document included construction plans for small in-residence safe rooms. FEMA P-320 was subsequently updated in 1999, 2008, 2014, 2021, and 2024.

For more information on FEMA's MAT Program and access to MAT Reports and Recovery Advisories, visit <https://www.fema.gov/emergency-managers/risk-management/building-science/mitigation-assessment-team>.

A1.3.2 DEVELOPMENT OF ICC 500

Using the first edition of FEMA P-361 (2000) as guidance, the ICC, in partnership with the NSSA, formed a national committee that FEMA participated in to codify design and construction requirements for tornado and hurricane storm shelters. This consensus standard, ICC 500, was completed in the summer of 2008 and updated in 2014, 2020, and 2023.

The purpose and scope of ICC 500 are:

ICC 500, "Section 101.1 Purpose. The purpose of this standard is to establish minimum requirements to safeguard the public health, safety, and general welfare relative to the design, construction, and installation of storm shelters constructed for protection from tornadoes, hurricanes and other severe windstorms. This standard is intended for adoption by government agencies and organizations for use in conjunction with applicable codes to achieve uniformity in the technical design and construction of storm shelters."

ICC 500, "Section 101.2 Scope. This standard applies to the design, construction, installation, and inspection of storm shelters constructed for the purpose of providing protection from tornadoes, hurricanes and other windstorms. Storm shelters shall be constructed as either separate detached buildings or rooms or spaces within new or existing buildings. Design of facilities for use as emergency shelters after the storm is outside the scope of this standard."

FEMA's ongoing participation in the ICC 500 consensus development process and direct reference to ICC 500 for the basis of safe room design are supported by federal policy outlined in the National Technology Transfer and Advancement Act (NTTAA) and the Office of Management and Budget (OMB) Circular A-119, *Federal Participation in the Development and Use of Voluntary Consensus Standards in Conformity Assessment Activities* (OMB, 2016; NIST, 2021):

- The NTTAA directs federal agencies with respect to their use of and participation in the development of voluntary consensus standards. The Act's objective is for federal agencies to

adopt voluntary consensus standards, wherever possible, in lieu of creating proprietary, non-consensus standards.

- OMB Circular A-119 establishes policies on federal use and development of voluntary consensus standards. This Circular directs agencies to use voluntary consensus standards in lieu of government-unique standards. Agencies should recognize the positive contribution of standards development and related activities. When properly conducted, standards development can increase productivity and efficiency in Government and industry, expand opportunities for international trade, conserve resources, improve health and safety, and protect the environment.

Participation in the development of ICC 500 has given FEMA an opportunity to shape evolving standard requirements that directly impact safe rooms as well as storm shelters. Participation has also provided a forum for direct collaboration with industry representatives and a wider spectrum of storm shelter subject matter experts, which has served to enrich both safe room guidance and storm shelter commentary.

Direct reference to ICC 500 for the basis of safe room design has benefitted FEMA safe room grant stakeholders by significantly reducing independent safe room requirements, which have been limited to the FEMA Funding Criteria presented at the beginning of the FEMA P-361 Part B chapters since the 2015 edition. Further, since the second edition of FEMA P-361 (2008), updates to FEMA's safe room resources have been synched with ICC 500 updates, resulting in coordinated criteria and guidance for safe rooms and storm shelters. Lastly, direct reference to ICC 500 for standardized testing and labeling criteria has allowed for greater availability and affordability of ICC 500-compliant safe room products (e.g., impact protective systems and prefabricated units), benefitting both consumers and industry.

Since 2009, the IBC and IRC have incorporated ICC 500 by reference to regulate the design and construction of buildings, or portions thereof, designated as storm shelters to provide life-safety protection from tornadoes and hurricanes. Under the 2009, 2012, 2015, 2018, 2021, and 2024 IBC and IRC, whenever a structure is designated as a "storm shelter," whether stand alone or within a host building, the ICC 500 standard must be met. In addition, Sections 423.4 and 423.5 of the 2015, 2018, and 2021 IBC require ICC 500 storm shelters to be incorporated when any of the following are constructed: K-12 school buildings with an occupant load of 50 or more; 911 call stations; fire, rescue, ambulance, and police stations; and emergency operation centers (EOCs). The requirement applies only in the 250-mile-per-hour (mph) tornado wind speed zone (see Figure B3-1 for wind speed zone details), with some exceptions allowed. For more information on storm shelter requirements in the building codes, see Section B1.2.2.

A1.3.3 ICC 500-2023 COMPARISON WITH FEMA P-361 (2024)

Although similar, FEMA P-361 and ICC 500 have important differences between requirements and criteria. Terminology differs too as described in Section A1.2. The purposes and scopes for both ICC 500-2023 and FEMA P-361 (2024) are outlined below:

- The purpose and scope of ICC 500 is to establish minimum requirements for the design, construction, installation, and inspection of storm shelters that provide life-safety protection from tornadoes, hurricanes, and other severe windstorms.
- The purpose and scope of FEMA P-361 is to provide guidance for safe rooms that provide near-absolute life-safety protection for occupants during an extreme-wind event. Part A addresses risk assessment, economic considerations, and emergency management considerations for safe rooms. Part B provides guidance on design, construction, installation, and inspections of safe rooms and is organized according to the same chapters as ICC 500.

FEMA regularly reviews its safe room design criteria and believes some issues related to the design wind speed or tornado speed for residential safe rooms, flood hazards, fire safety, essential features, and operating a safe room warrant a more conservative approach than the outcome of the ICC 500 consensus standard process. FEMA Funding Criteria and best practices related to these topics are described in this publication. In addition to the technical differences between ICC 500 and FEMA P-361, users should note that FEMA P-361:

- Uses the term “safe room” to indicate a structure designed and constructed to meet both the ICC 500 and the FEMA Funding Criteria in FEMA P-361
- Includes FEMA Funding Criteria and best practices, while ICC 500 is a minimum standard
- Includes guidance on extreme-wind risk assessment and economic considerations for protection from extreme winds that are not addressed in ICC 500
- Includes guidance for emerging issues and concerns based on lessons learned by FEMA from assessments conducted after extreme-wind events

A1.3.4 FEMA SAFE ROOM GRANT FUNDING PROGRAM

FEMA is committed to the development of design and construction criteria and guidance for safe rooms and continues to support safe room construction as evidenced by safe room initiatives made available through several FEMA grant programs.

As of February 2024, FEMA has provided approximately \$1.45 billion in FEMA funds towards the design and construction of over 40,000 residential and nearly 2,200 community safe rooms in 25 states and territories.

NOTE

FEMA Hazard Mitigation Assistance (HMA) Funds

The FEMA *HMA Program and Policy Guide* is updated periodically. For more information on safe room grant eligibility, download the most current *HMA Program and Policy Guide* from <https://www.fema.gov/grants/mitigation/hazard-mitigation-assistance-guidance>.

To use FEMA funds to support design and construction of a safe room, all FEMA Funding Criteria (described in Part B of this publication and summarized in Table D-1 in Appendix D) must be met.

FEMA provides HMA funding to eligible states, tribes, and territories that, in turn, provide the funding to local governments to assist in reducing overall risk to people and property. Information about various funding types (including some from non-FEMA sources) can be found on FEMA’s “Safe Room Funding” webpage at <https://www.fema.gov/emergency-managers/risk-management/building-science/safe-rooms/funding>.

Safe room funding may be available through FEMA programs including the Hazard Mitigation Grant Program (HMGP), HMGP Post Fire, Building Resilient Infrastructure and Communities (BRIC), and the Safeguarding Tomorrow Revolving Loan Fund Program. Funding may also be available from other sources such as the U.S. Department of Housing and Urban Development (HUD) Community Development Block Grant (CDBG) Funds and Federal Housing Administration Mortgage Insured Financing.

A Hazard Mitigation Officer (HMO) can answer questions regarding project eligibility and financial assistance and provide detailed information on funding sources. The HMO can also advise what information must be provided for a safe room project to be considered for funding, as well as any applicable federal, state, and local design requirements.

Another resource for questions regarding safe room funding is FEMA’s HMA Grants Helpline, which can be contacted by calling 1-866-222-3580 or email at fema-hmahelpline@fema.dhs.gov.

A1.4 Deciding Whether to Install or Construct a Safe Room

Many factors may influence the decision to install or construct a safe room. They include:

- The likelihood of the location being threatened by an extreme-wind event (see Chapter A2)
- The vulnerability of a structure to an extreme-wind event (see Chapter A2)
- The risk or potential losses (including deaths and injuries) associated with an extreme-wind event (see Chapter A2)
- The benefits and costs of constructing a safe room (see Chapter A3)

In addition to the above factors, the following indirect factors may influence the decision to build or install a safe room:

- The safe room is required by Section 423.4 or 423.5 of the IBC.²

² Currently, the 2015, 2018, 2021, and 2024 IBC contain this requirement.

- The potential for death or injury may be reason enough to build or install a safe room at a given site.
- The benefit-cost ratio (BCR) of a safe room (see Section A3.2) may be a factor in the decision, or a minimum BCR may be required by the funding source.
- Residents feel unsafe without a safe room.
- A business, non-profit, or other organization wants to provide protection for its employees or its employees and members/customers/visitors. For FEMA funding eligibility, refer to the *HMA Program and Policy Guide*.
- A safe room would allow faster business/organizational recovery after an extreme-wind event by protecting employees/members/visitors from injuries or fatalities.
- A building that is required to, or would benefit from, shelter-in-place options for building occupants during an extreme-wind event, including but not limited to critical facilities not covered by Section 423 of the IBC.
- The building is a government-owned building that is required to have a safe room.
- Local ordinances require a safe room.
- There may be insurance benefits associated with having a safe room.

The flowchart in Figure A1-1 presents the decision-making process when considering whether to build or install a safe room. The main steps of this process are discussed throughout Part A.

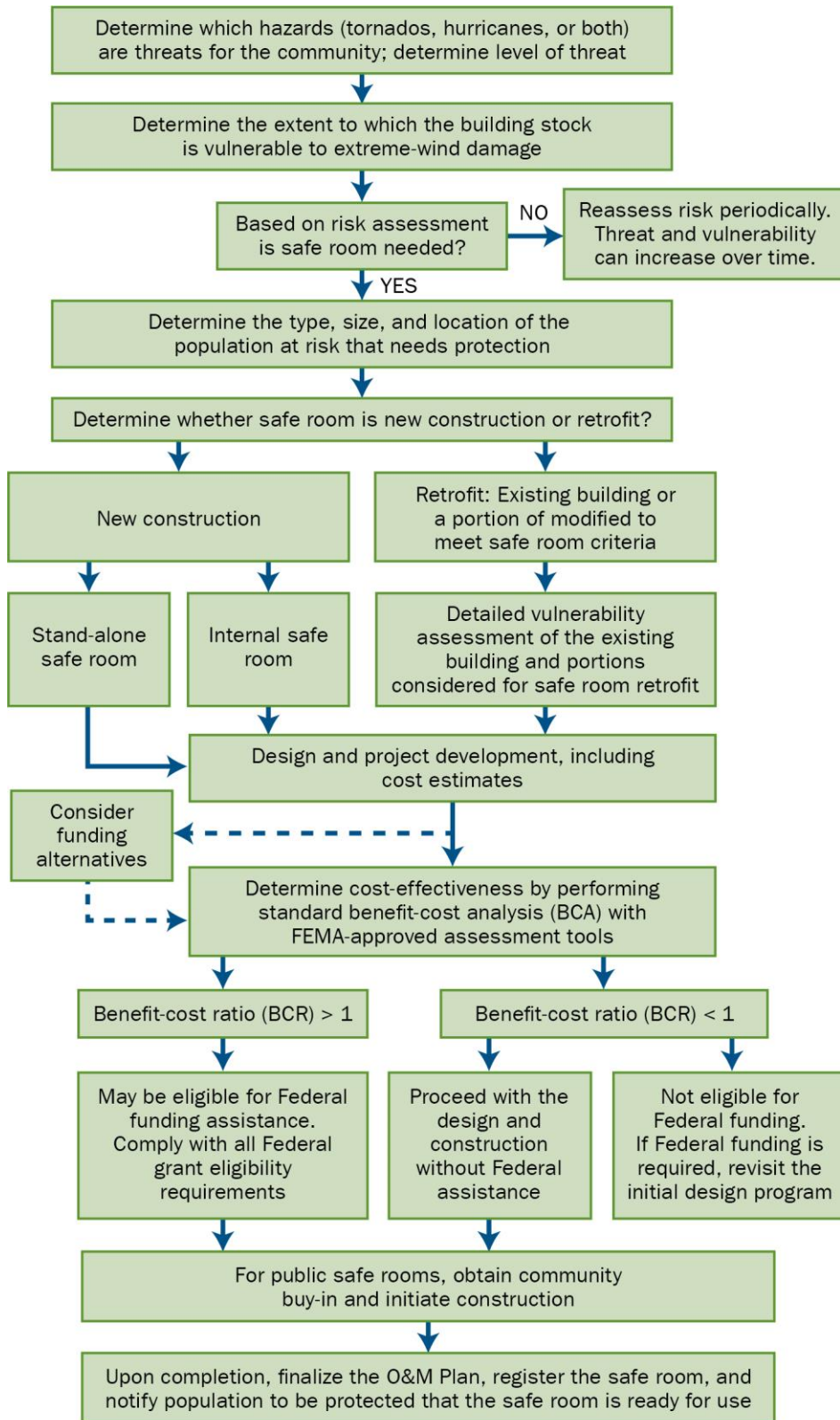

Figure A1-1: Safe room decision-making flowchart

Chapter A2 Extreme-Wind Risk Assessment and Analysis

Unless a safe room is required by the locally adopted building code³ or the authority having jurisdiction, the safe room decision-making process should begin with risk assessment. The final decision to move forward with a safe room project may hinge on a single factor, a single consequence, or on an array of factors and consequences (refer also to Section A1.4). Factors to take into consideration could include the need to provide protection for an especially vulnerable population (e.g., hospital patients) that cannot be easily moved or populations that are difficult to move (e.g., young children) in vulnerable buildings on a campus. Nevertheless, FEMA recommends a comprehensive risk assessment process that considers the following:

- Type of extreme-wind hazard (tornado, hurricane, or cyclone, typhoon or other storm with high winds, or a combination of these hazards)
- Threat or probability and potential severity of the hazard based on historical occurrences
- Vulnerability of the building or buildings in the community intended to be served by a community safe room
- Size of the population that is vulnerable

TERMINOLOGY

Hazard: Event that has the potential to cause damage or losses, including injury or death.

Risk: Potential losses—both the short- and long-term effects—associated with a hazard. Risk is associated with threat (hazard) and vulnerability.

Threat: The probability that an event of a given recurrence interval will affect a specific location within a specified period.

Vulnerability: Weaknesses in the building- or site-related factors, such as terrain exposure or nearby debris sources (e.g., weak buildings or gravel roofs), that may result in losses or damages.

Risk assessment should be followed by project planning. Project planning includes risk analysis to determine protection needs and prioritize subsequent mitigation activities. If a comprehensive risk assessment and risk analysis indicates the need for a safe room, individuals and communities should begin identifying feasible safe room options. When constructing a new safe room is not a

³ Sections 423.3 and 423.4 of the 2015 and 2018 IBC, and Sections 423.4 and 423.5 of the 2021 and 2024 IBC require ICC 500-compliant storm shelters to be incorporated when any of the following are constructed: K-12 school buildings with an occupant load of 50 or more; 911 call stations; fire, rescue, ambulance, and police stations; and EOCs. The requirement applies only in the 250-mile-per-hour (mph) tornado wind speed zone (see Figure B3-1 for wind speed zone details), and some exceptions are allowed.

feasible solution to serve an existing building, retrofitting a portion of the building with a safe room may be the best solution.

A2.1 Risk Assessment

The risk of occurrence of tornadoes or hurricanes is not evenly distributed throughout the United States. The safe room risk assessment process for any given location has two major elements:

1. **Assessing threat:** The threat of the occurrence of an extreme-wind event
2. **Assessing vulnerability:** The vulnerability of the community's building(s) and population to the hazard

Potential community-specific consequences from the extreme-wind hazard may then be developed from the results of the threat and vulnerability assessments. Potential consequences may be further informed from available statistics such as annual averages of injuries and fatalities from the hazard. The following section guides the reader through the process of performing risk assessments.

More Information

FEMA P-320, Section 2.6, presents a simplified approach to risk assessment for homeowners.

A2.1.1 ASSESSING THREAT

After determining the site-specific extreme-wind hazard(s) (tornado, hurricane, or both), assessing the level of threat is the next step in risk assessment. The level of threat is determined by the probability of a specific magnitude event occurring at the location under consideration. The probabilities of occurrence are statistical estimates drawn from historical records of previous hazard events or computer simulations that describe not only the time and location, but also the intensity, size, duration, general circumstances, and effects of the event.

Much of this information has been compiled by FEMA and other entities, such as the American Society of Civil Engineers/Structural Engineering Institute (ASCE/SEI), into risk assessment tools, such as wind speed maps and hazard event frequency maps and tables. Because the threat differs greatly in various parts of the country, tornado and/or hurricane wind speed maps can be used to gauge the site-specific level of threat for either event as related to other geographical areas. ICC 500 wind speed maps should be used for safe room design while the building in which the safe room is constructed should be designed in accordance with the ASCE 7 wind speed map or tornado speed map as applicable (see "ASCE 7-22 Tornado Design v. ICC 500 Design" textbox in Section A2.1.1.1 for more information). Both tornado and hurricane ICC 500 wind speed maps and additional commentary on their development may be found in Section B3.2.5. For all FEMA-funded residential safe rooms, the design wind speed should be 250 mph, regardless of location. While wind engineering research is ongoing, the guidance and FEMA Funding Criteria provided in this publication is based on the best available information at this time. The remaining sections on tornado and hurricane threats provide additional commentary and guidance on using wind speed maps for assessing the threat.

A2.1.1.1 Tornado Threat

Modeling and mapping the tornado hazard is more challenging than the hurricane hazard because currently available data are relatively incomplete. The information available on tornadoes is limited by shorter history of records (modern records keeping of tornadoes did not begin until 1950) and early records relied solely on eyewitness accounts. This resulted in under-reporting, especially in rural areas with less people to witness events. Modeling and mapping are also more challenging because of the inability to directly measure tornado wind speeds; whereas for hurricanes, instrumentation can be flown into the storm to capture critical atmospheric data. Furthermore, because the area of land directly affected by tornadoes is relatively small, tornado-related winds have a significantly lower probability of occurrence at a specific point than the high winds associated with other larger meteorological events (frontal systems, thunderstorms, and hurricanes). Although the basic wind speed maps in Chapter 26 of ASCE 7-22 do not include tornado hazard data and cannot be used for assessing the tornado threat, tornado hazard maps are now available in Chapter 32, “Tornado Loads,” and Appendix G, “Tornado Hazard Maps for Long Return Periods” of ASCE 7-22.

NOTE

ASCE 7-22 Tornado Design v. ICC 500 Design

With the publication of ASCE 7-22, tornado load requirements are now considered as a minimum design load in conventional Risk Category III and IV building design when located in tornado-prone areas. Tornado hazard maps were developed to define design tornado speeds for a range of return periods. The mapped tornado speeds represent the 3-second-gust tornado speed at 33 feet above the ground. Design tornado speeds use a 1,700- and 3,000-year return period for Risk Category III and IV buildings, respectively. Design tornado speeds are also a function of the plan size and shape of the building, other structure, or facility, as measured by the effective plan area, A_e ; the larger the facility, the greater the tornado strike probability. For more information see the FEMA/NIST *Design Guide for New Tornado Load Requirements in ASCE 7-22* available at <https://www.fema.gov/emergency-managers/risk-management/building-science/disaster-support>.

As emphasized in the User Note provided at the beginning of ASCE 7 Chapter 32 and in Chapter 32C commentary (as well as the above-referenced Design Guide), buildings and other structures designed per Chapter 32 of ASCE 7 do NOT meet the requirements for storm shelters or safe rooms, which MUST adhere to ICC 500 and FEMA P-361, respectively. Storm shelters and safe rooms are specifically designed for enhanced life-safety protection during the most extreme wind events and require more extreme design hazard intensities than conventional buildings, especially with respect to occupant protection from windborne debris.

The estimated wind speed of a tornado is categorized by the Enhanced Fujita (EF) Scale shown in Figure A2-1. The EF Scale uses observations of damage, primarily to vegetation and buildings, to estimate the magnitude of 3-second gusts likely to have caused the observed damage. ASCE 7 tornado speed maps also use 3-second gust wind speeds.

Despite their rarer occurrence in comparison with weaker tornadoes, strong tornadoes are responsible for most tornado fatalities (refer to Table B3-3 to see the percentage of the occurrence of different rated tornadoes). Between 1950 and the end of 2022, approximately 85% of all tornado fatalities were caused by tornadoes rated EF3 and greater (NOAA, unpublished data). To capture and communicate the tornado threat as a function of tornado intensity, the National Oceanic and Atmospheric Administration (NOAA) provides data showing areas historically subjected to the highest number of strong tornadoes. Figure A2-2 shows the tornado tracks of recorded strong and violent tornadoes, those designated as EF3, EF4, or EF5, within the contiguous United States. Alaska, Hawaii, and U.S. island territories are not included because no tornadoes rated EF3 or greater have been recorded in those locations.

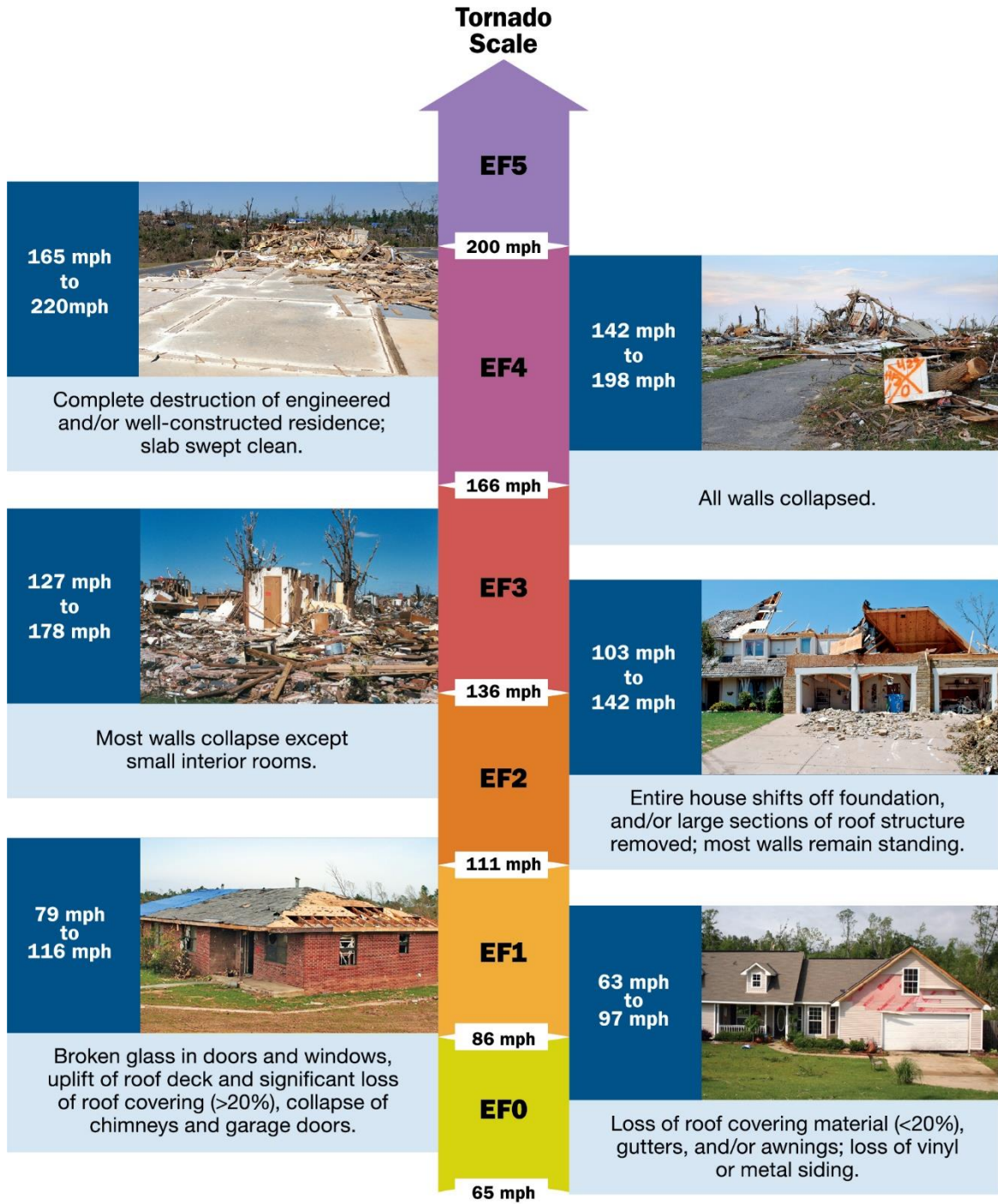
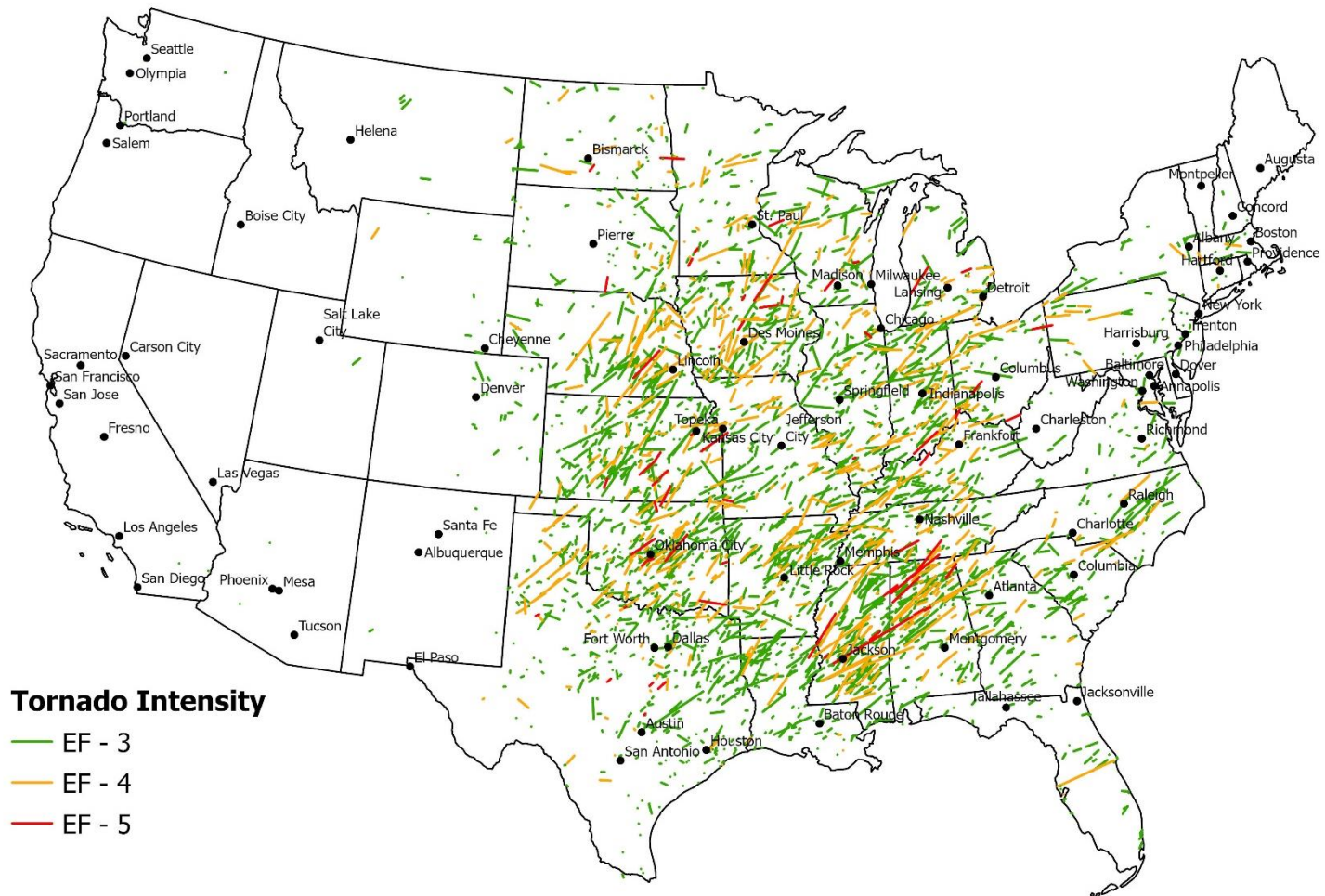

Figure A2-1: Typical tornado damage descriptions to one- and two-family dwellings and their corresponding intensity according to the EF Scale



SOURCE: NOAA NATIONAL WEATHER SERVICE, STORM PREDICTION CENTER

Figure A2-2: Recorded EF3, EF4, and EF5 tornadoes in the contiguous United States from 1950 through 2022. Tracks illustrate path lengths, frequencies, and locations of extreme tornadoes; however, the widths of the track lines are greater than the widths of the areas prone to damaging winds (are not to scale)

The ICC 500 tornado storm shelter wind speed design map (see Figure B3-1) was developed using a deterministic analysis of NOAA's recorded tornado data to correlate the mapped frequency of strong tornadoes with four tornado wind speed zones: 250 mph, 200 mph, 160 mph, and 130 mph. The higher the tornado wind speed zone associated with any given location, the greater the threat from strong tornadoes. However, the ICC 500 tornado storm shelter wind speed design map does not show a high level of detail. Therefore, the design wind speed needed for a site may not be clear when the site is near a wind zone contour line. Designers and code officials should recognize that the mapped design wind speed contour lines were not drawn or intended to be interpreted as precise geographic coordinates. When planning or designing safe rooms, designers should remember that the intended purpose of a safe room is to protect people from death or injury. Accordingly, when the site is near a line of delineation between zones, the prudent approach is to assume the site lies within the higher tornado wind speed zone.

For more commentary on tornado probability related to ICC 500 wind speed maps, please refer to Section B3.2.5.1.2.

A2.1.1.2 Hurricane Threat

The basic wind speed maps published by ASCE incorporate hurricane hazard data and can be used to assess the hurricane threat (see Figure A2-3). Aside from Alaska (see Section B3.2.5.1.4) and designated Special Wind Regions (see shaded areas in Figure A2-3), coastal regions of the country with the greatest mapped speeds have the highest level of threat from hurricane winds.

NOTE

Hurricane-Prone Region

ASCE 7-22, *Minimum Design Loads and Associated Criteria for Buildings and Other Structures*, defines the hurricane-prone region in the United States and its territories as the U.S. Atlantic Ocean and Gulf of Mexico coasts where the design wind speed is greater than 115 mph for Risk Category II Buildings (reference Figure A2-3). The hurricane-prone region also includes Hawaii, Puerto Rico, Guam, U.S. Virgin Islands, Northern Mariana Islands, and American Samoa.

The severity of hurricanes is categorized by the NWS using the Saffir-Simpson Hurricane Wind Scale, which ranks hurricanes based on sustained wind speeds (see Figure A2-4). The scale ranges from Category 1 to Category 5, with Category 5 having the highest sustained wind speeds and the most potential for destruction. Unlike nearly all tornadoes, hurricane wind speeds can be directly measured. However, aside from aircraft upper-level measurements, aircraft-deployed dropsonde, and some buoy data, land-based instruments have rarely captured full-time histories of near-surface winds in eyewalls of hurricanes. Figure A2-4 shows the wind speed ranges and typical damage for each of the five hurricane categories. The wind speeds used in the Saffir-Simpson Hurricane Wind Scale have a different basis than ASCE 7 wind speeds, which are used in engineering design of buildings and primarily referenced in this publication. Hurricane categories are defined by the NWS in terms of sustained wind speeds over open water, while ASCE 7 uses 3-second peak gust wind speeds over land in flat, open terrain. The relationship between Saffir-Simpson Hurricane Wind Scale speeds and ASCE 7-22 wind speeds is shown in Table A2-1.

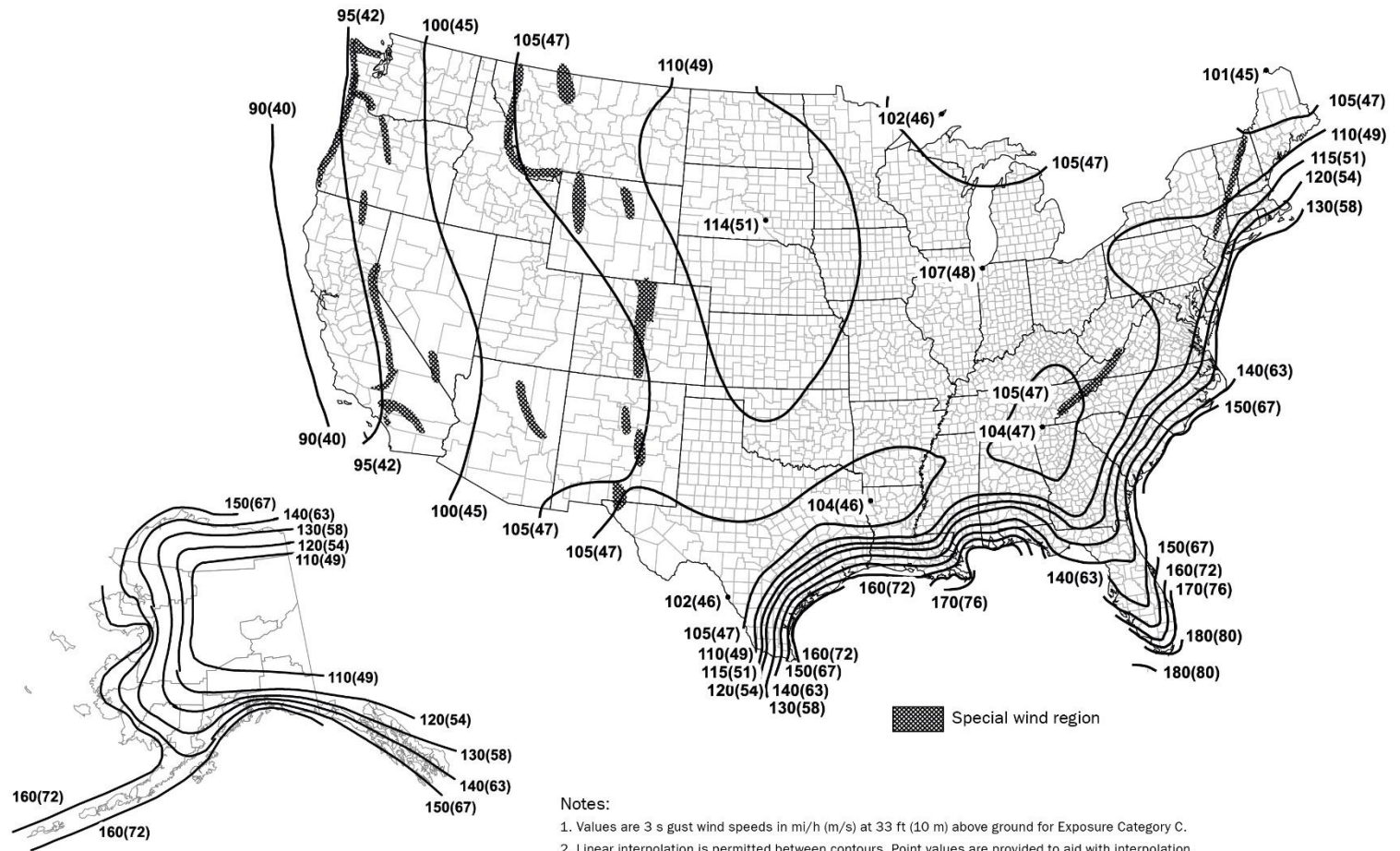

Location	V (mi/h)	V (m/s)
American Samoa	160	(72)
Guam & Northern Mariana Islands	195	(87)
Hawaii	ASCE Wind Design Geodatabase	
Puerto Rico	ASCE Wind Design Geodatabase	
U.S. Virgin Islands	ASCE Wind Design Geodatabase	

Notes:

1. Values are 3 s gust wind speeds in mi/h (m/s) at 33 ft (10 m) above ground for Exposure Category C.
2. Linear interpolation is permitted between contours. Point values are provided to aid with interpolation.
3. Islands, coastal areas, and land boundaries outside the last contour shall use the last wind speed contour.
4. Location-specific basic wind speeds shall be permitted to be determined using the ASCE Wind Design Geodatabase.
5. Wind speeds for Hawaii, US Virgin Islands, and Puerto Rico shall be determined from the ASCE Wind Design Geodatabase.
6. Mountainous terrain, gorges, ocean promontories, and special wind regions shall be examined for unusual wind conditions. Site-specific values for selected special wind regions shall be permitted to be determined using the ASCE Wind Design Geodatabase.
7. Wind speeds correspond to approximately a 15% probability of exceedance in 50 years (Annual Exceedance Probability = 0.00143, MRI = 700 years).
8. The ASCE Wind Design Geodatabase can be accessed at the ASCE 7 Hazard Tool (<https://asce7hazardtool.online>) or approved equivalent.

SOURCE: FIGURE 26.5-1B (RISK CATEGORY II) OF ASCE 7-22, USED WITH PERMISSION FROM ASCE

Figure A2-3: Basic wind speeds for Risk Category II buildings and other structures

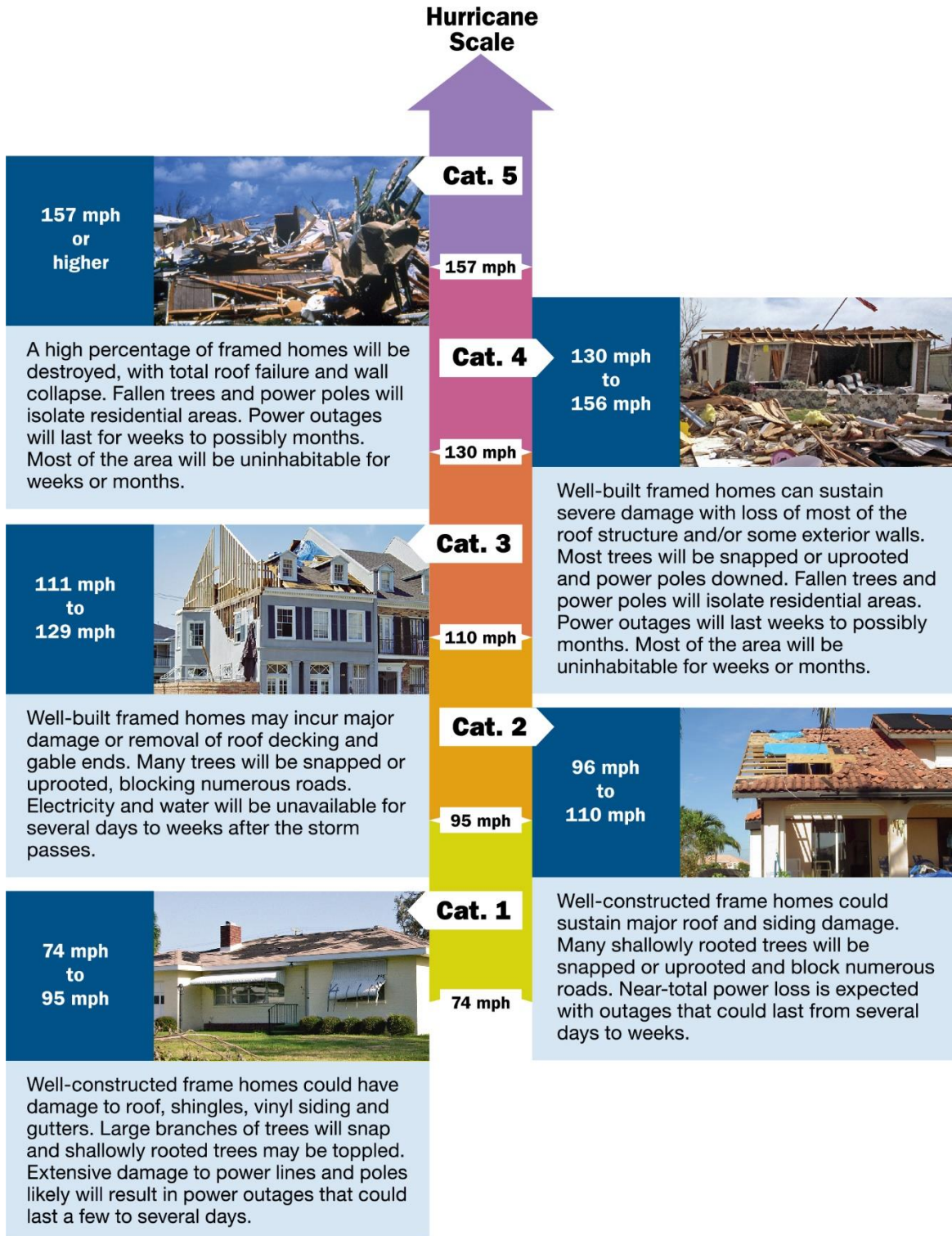

Figure A2-4: Typical hurricane damage descriptions to one-and two-family dwellings and thier corresponding intensity accordig to the Saffir Simpson Hurricane Wind Scale

Table A2-1: Approximate Equivalent Wind Speeds in ASCE 7-22 and Saffir-Simpson Hurricane Wind Scale

Saffir-Simpson Hurricane Category	Sustained Wind Speed Over Water ^(a)		Gust Wind Speed Over Land ^(b)	
	mph	(m/s)	mph	(m/s)
1	74–95	33–42	81–105	36–47
2	96–110	43–49	106–121	48–54
3	111–129	50–57	122–142	55–63
4	130–156	58–69	143–172	64–76
5	> 157	> 70	>173	>77

SOURCE: ADAPTED FROM TABLE C26.5-2 OF ASCE 7-22 COMMENTARY

Notes:

(a) 1-minute average wind speed at 33 feet above open water

(b) 3-second gust wind speed at 33 feet above open ground in Exposure Category C.

mph = miles per hour; m/s = meters per second

NOAA maintains a hurricane database associated with a tool that maps previous hurricane tracks. Records for the Atlantic Basin extend as far back as 1851. ASCE 7-22 wind speed maps are based on hurricane mean recurrence intervals (MRIs) ranging up to 3,000 years (approximately 1.6% probability of exceedance in 50 years). The ICC 500 hurricane wind speed map in this publication (see Figure B3-2) was developed using the same methodology used to model hurricane wind speeds for the ASCE 7 wind speed map but uses instead a 10,000-year MRI (0.5% probability of exceedance in 50 years).

Figure A2-5 shows the tracks of major hurricane eyes from 1950 through 2022, both right off the coast and those that made landfall in the United States and its territories. This figure provides an overview of number of hurricane strikes, but underrepresents the areas affected by wind hazard for any given event by only indicating the path of the storm's eye. Although the area affected by any landfalling hurricane varies significantly, the inset of Figure A2-5 demonstrates the large area affected by a single event, Hurricane Michael (2018).

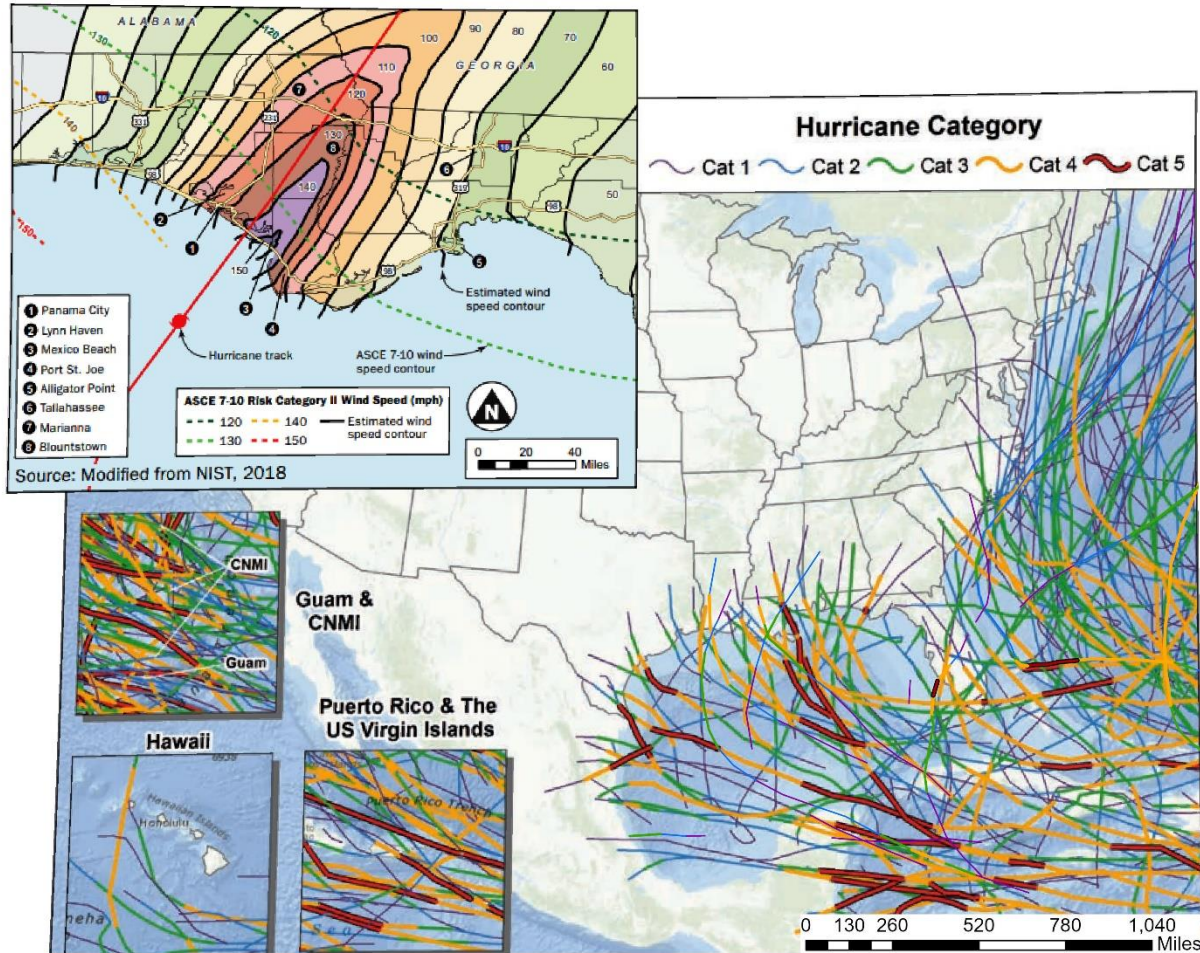

SOURCE: NOAA NATIONAL WEATHER SERVICE, STORM PREDICTION CENTER

Figure A2-5: Major hurricane eye tracks along the United States and its territories from 1950 through 2022 providing an overview of the number and location of hurricane strikes with an inset demonstrating the large area impacted by a single event (Hurricane Michael; preliminary peak wind swath plot of estimated 3-second gust wind speed in mph at a height of 33 feet above ground, Exposure C [solid lines; ASCE 7-10 was the referenced standard by the 6th Edition Florida Building Code in place at the time of landfall with its contours shown as dashed lines])

When assessing the hurricane threat using wind speed maps, it may be helpful to consider information presented in both maps (ASCE 7 and ICC 500) depending on the location within the hurricane-prone region. Care should be taken to reference the specific maps used for the risk assessment. Only the ICC 500 wind speed map for hurricanes should be used to determine the hurricane safe room design wind speed.

For more commentary on hurricane probability related to ICC 500 wind speed maps, refer to Section B3.2.5.1.3.

A2.1.1.3 Multi-Hazard Threat

Safe rooms are designed and built to protect occupants from tornadoes and/or hurricanes. The objective should not divert designers' and local decision-makers' attention from the presence of other hazards, both natural and human-caused. For this reason, designers and local officials alike should adopt a multi-hazard approach from the very beginning of their safe room deliberations. A multi-hazard approach ensures a comprehensive risk assessment, appropriate mitigation responses, and more cost-effective design solutions over the life cycle of a building.

The potential adverse effects of other hazards on the functionality of safe rooms should be identified, evaluated, and documented. The final risk analysis should include these multi-hazard considerations to produce as comprehensive a list of design objectives as possible.

Multi-hazard design considerations can present advantages and disadvantages for the safe room designer. On the one hand, two or more hazards may pose design requirements that reinforce each other, thus reducing costs and improving protection. On the other hand, design requirements for some hazards may be conflicting, thereby making them difficult to reconcile. For example, wind-resistant structures benefit from more rigid design, while earthquake resistance is enhanced through greater structural flexibility. Massive reinforced-concrete roof sections, typically specified to resist extreme-wind pressures and debris impact, are detrimental for earthquake-resistant design. Another example of multi-hazard conflict occurs when a safe room is needed in an area where a flood hazard is present. Guidance on addressing safe room siting and design challenges related to flood hazard is provided in Chapter B4, "Siting." In addition to earthquake and flood hazards, protecting safe room occupants from fire hazards presents unique design and operational challenges, as described in Chapter B6, "Fire Safety."

As noted in Section A1.4, the risk assessment process—including consideration of site-specific consequences and multi-hazards—should inform the decision of whether to pursue the installation of one or multiple safe rooms.

A2.1.2 ASSESSING VULNERABILITY

After assessing the tornado or hurricane hazard threat for the specified location, vulnerability should be assessed. In addition to assessing the vulnerability of buildings to damage from extreme-wind events (Section A2.1.2.1), this publication also recommends that vulnerable populations be identified (such as elderly, those with mobility limitations, children, etc.) (Section A2.1.2.2). For safe

room risk assessment purposes, vulnerable populations are those who are likely unable to be evacuated or unable to seek shelter from the area likely to be impacted by the impending storm.

A2.1.2.1 Assessing Building Vulnerability

After evaluating the threat level (Section A2.1.1.), the second step of the risk assessment is to assess the potential vulnerability of the community's (or building owner's) building stock to wind damage that could lead to casualties. This step is especially critical for high-capacity buildings and buildings that house vulnerable populations, or campuses with these types of buildings.

Identifying building or community vulnerabilities

If building owners wish to assess the vulnerability of their building(s), they should have an RDP conduct an inventory and ranking of the owner's building stock. This can be done in two parts:

1. **Assessment:** The first part is an assessment of the building vulnerabilities; this assessment should include building-specific factors such as structural integrity, age, condition, building materials, design, and quality of construction to identify components vulnerable to the identified hazard. Many resources are available for assessing building vulnerabilities to extreme wind, including FEMA's *Best Available Refuge Area Checklist*⁴ and the tornado loads commentary in Chapter 32C of ASCE 7-22. An RDP familiar with these types of assessments should be engaged.
2. **Ranking:** The second part involves ranking the buildings according to the level of potential risk of serious injury or death to building occupants. This part is an especially important component of a vulnerability assessment to assist the building owner in prioritizing their safe room needs.

NOTE

Local Hazard Mitigation Plans

Another potential source of information to help homeowners assess risk from tornadoes, hurricanes, and other natural hazards is their "Local Hazard Mitigation Plan." Nearly 84% of the nation's population lives in communities with current FEMA-approved hazard mitigation plans, as an adopted plan is a condition for receiving certain types of FEMA non-emergency disaster assistance, including funding for mitigation projects. For more information on this requirement, visit <https://www.fema.gov/emergency-managers/risk-management/hazard-mitigation-planning>.

To check if your state, local, tribal, and/or territorial government has a Local Hazard Mitigation Plan, visit <https://www.fema.gov/emergency-managers/risk-management/hazard-mitigation-planning/status>.

⁴ Although the primary function of FEMA's *Best Available Refuge Area Checklist* is to identify a building's areas that are least vulnerable to the life-threatening effects of extreme wind events, it may also be used to rank a group of facilities in a given geographic region as described in the checklist's introduction.

If a community wishes to evaluate its vulnerability, it would take similar steps as those described above for a building owner. Once the community-wide threat assessment is completed (Section A2.1.1), decision-makers should then consider their community's building stock as a whole to help determine where their community is most vulnerable (high percentage of manufactured homes or substandard structures or vulnerable populations). This information can help in the project-planning phase for locating community safe rooms. A community may also have a Local Hazard Mitigation Plan, which can provide useful information as described in the "Local Hazard Mitigation Plans" textbox above. An RDP can also perform the two steps listed above, taking into account an authority having jurisdiction's inventory of building stock.

Identify options for providing safe rooms

After ranking the building stock according to the level of vulnerability, the building owner or community should identify opportunities to build stand-alone safe rooms, build safe room additions to existing buildings, or even retrofit a portion of an existing building to meet safe room criteria.

NOTE

Best Available Refuge Areas for Tornadoes

See FEMA P-431, *Tornado Protection: Selecting Refuge Areas in Buildings* (2009), for guidance in selecting BARAs for tornadoes. An updated *Best Available Refuge Area Checklist* was published in 2017 as an Appendix to the 2009 FEMA P-431 and can be found at <https://www.fema.gov/emergency-managers/risk-management/building-science/safe-rooms/resources>.

NOTE

Best Available Refuge Areas for Hurricanes

Following Hurricanes Irma and Maria impacting Puerto Rico in 2017, FEMA developed a job aid titled *Best Available Refuge Area Assessment Guide for Puerto Rico Hurricane Wind Hazards* (FEMA, 2019a). The job aid introduces the Refuge Area Assessment Guide (RAAG), a spreadsheet-based software tool specifically adapted for use on low-rise concrete or masonry school buildings in Puerto Rico. Although the RAAG cannot substitute for a detailed engineering analysis, it can be used to provide objective guidance for hurricane refuge area selection. For more information on the job aid and any subsequent BARA methodology updates, please contact the FEMA Safe Room Helpline by email at saferoom@fema.dhs.gov or by calling 866-927-2104.

Identifying best available refuge areas within buildings

The term "best available refuge area" (BARA) refers to a building area (or areas) that has been determined by an RDP to be least vulnerable to the life-threatening effects of extreme-wind events relative to other building areas.

FEMA recommends that BARAs be identified by an RDP who is familiar with the procedure. The BARA should be regarded as an interim measure only until a safe room is made available to the building occupants. Additionally, all mandatory evacuation orders given by an authority having jurisdiction must be followed in lieu of sheltering in a BARA.

Because these areas were not specifically designed as tornado or hurricane safe rooms, their occupants could be injured or killed during a tornado. However, people in BARAs are less likely to be injured or killed than people in other areas of the same building.

Hurricane sheltering programs

Many states and U.S. island territories use assessments of existing buildings to identify shelter areas for use by the public, both during and after hurricanes. These areas are different than safe rooms and storm shelters and should be identified using distinctly different terminology so the level of protection afforded is not misunderstood by users. “Safe room” and “storm shelter” are intended to convey life-safety protection from extreme winds in accordance with performance criteria provided in FEMA P-361 and ICC 500, respectively, and should be used consistently across all states, territories, and jurisdictions.

FEMA MAT deployments in Puerto Rico after Hurricanes Irma and Maria (2017) and in Florida after Hurricanes Michael (2018) and Ian (2022), provided opportunities to assess existing hurricane sheltering programs in the Commonwealth and state. A brief overview of observations and lessons learned related to the designation of existing building areas for hurricane shelters, other than storm shelters and safe rooms, follows. For more details, refer to FEMA P-2020, *Mitigation Assessment Team Report: Hurricanes Irma and Maria in Puerto Rico* (2018), FEMA P-2077, *Mitigation Assessment Team Report: Hurricane Michael in Florida* (2020), and FEMA P-2342, *Mitigation Assessment Team Report: Hurricane Ian in Florida* (2023).

In Puerto Rico, the Department of Housing (DOH) maintains the primary program for identifying and managing hurricane evacuation shelters (HESs) across the Commonwealth. The program evaluates and tracks facilities to be used as “event-specific” shelters and post-event shelters. Assessments are conducted on a yearly basis by representatives from DOH, the Puerto Rico Department of Education (DOE), and the Puerto Rico Emergency Management Agency (PREMA). When a storm threatens, DOH, DOE, and PREMA work together to confirm the designations of event-specific shelters and post-event facilities; municipalities then open and operate the facilities. Before Hurricane Maria made landfall in September 2017, 257 event-specific shelters were open and in operation across all 78 municipalities to provide available refuge during the storm for residents who evacuated their homes. None of the facilities currently in the shelter inventory were designed or constructed to meet the requirements of FEMA P-361 or ICC 500.

FEMA P-2020 concluded (Conclusion PR-34) that the Puerto Rico DOH shelter program is helpful but has shortcomings. With respect to the assessment of existing buildings for use as hurricane refuge areas, the report recommends (Recommendation PR-34b) that FEMA work with the Puerto Rico DOH to improve the evaluation form for the DOH shelter program by requiring the collection of additional building information. Building performance observations of three “event-specific” shelters are

included in Section 4.5 of FEMA P-2020, which notes that in addition to lacking backup or emergency power supply, two of the three shelters suffered water intrusion into shelter spaces via metal panel jalousies that covered all exterior windows but were not designed to provide debris impact protection. See the “Best Available Refuge Areas for Hurricanes” textbox on page 32 for information on the FEMA-developed job aid to address Recommendation PR-34b.

In Florida, the Division of Emergency Management (FDEM) updates the *Statewide Emergency Shelter Plan* every other year to provide detailed information on the current inventory of HES spaces along with current and projected shelter capacity deficits (or surpluses) for every Florida county. Like Puerto Rico, nearly all of Florida’s hurricane refuge areas are located within public schools and are opened and operated by local officials. While the Florida Building Code (FBC) provides Enhanced Hurricane Protection Area (EHPA) criteria where shelter space is required in new schools, local authorities can satisfy the estimated shelter capacity demands in their county by identifying available shelter space in existing buildings. Qualifying existing buildings for state-recognized shelter space requires assessing selected buildings or building areas using the American Red Cross *Standards for Hurricane Evacuation Shelter Selection* (ARC HESSS, formerly ARC 4496; 2002) and *ARC 4496 – Prescriptive Summary Table* (FDEM, 2014). Based on the survey findings, the assessor assigns a qualitative ranking—preferred, less preferred/marginal, or further investigation/mitigation required—to 15 HES criteria categories. Mitigation of any shelter vulnerability may improve the ranking of buildings under consideration.

NOTE

Refuge Area “Near Miss”

One of the two Florida HESs visited by the Hurricane Michael MAT and designated through assessment of existing building areas was not opened for Hurricane Michael. The other, on Rutherford High School’s campus, sheltered over 1,100 members of the surrounding community and lost a large portion of the steel roof deck above an HES-designated area during the height of the storm. Although the second-floor area directly below the lost roof deck was unoccupied, the building required evacuation during the hurricane because rain from the open roof area was inundating the first floor. Although no serious injuries were reported, failure of the roof assembly endangered staff and the general public who sought shelter in the HES.

Building performance observations of two HESs that were identified within existing school buildings are included in Section 5.2.3 of FEMA P-2077, which notes that both suffered roof damage and wind-driven rain infiltration. The MAT Report concludes (Conclusion FL-21) that the observed HESs demonstrated significant vulnerabilities to high-wind hazards. With respect to the assessment of existing buildings for use as hurricane refuge areas, the report recommends (Recommendation FL-21a) that the State of Florida and FDEM consider re-evaluating their policies, procedures, and requirements for assessments of existing spaces for use as HESs. Specifically, FDEM should consider requiring more robust and holistic vulnerability assessments for future HESs that are designated through assessment and mitigation of existing spaces.

As evidenced from the discussion of Puerto Rico and Florida above, each state typically has its own terminology and criteria for different shelter types. “Safe room” and “storm shelter” have their own specific definitions (as they are used in this publication) that are to be used consistently across all states, territories, and jurisdictions. Table A2-2 provides a summary of different sheltering terminology discussed in this publication.

A2.1.2.2 Assessing Vulnerable Population

Some considerations related to determining the vulnerable population are described below. The emergency management measures necessary to afford protection to thousands of occupants of large, public venues such as stadiums or amphitheaters are beyond the scope of this publication.

Identifying the vulnerable population is necessary not only to evaluate risk (i.e., determine potential losses as a result of a disaster), but also for effective mitigation; this information is used to determine the location and optimal size/capacity of a community safe room. Because the warning times for approaching hurricanes are considerably longer than for tornadoes, the vulnerable population for hurricane safe rooms serving communities with vehicular access to the U.S. mainland might include those who must remain in the area, such as emergency response personnel, and those who are unable to evacuate on time because of their access and functional needs, lack of transportation, lack of a suitable place to go, or other reasons.

NOTE

Vulnerable Population

According to FEMA’s *HMA Program and Policy Guide (2024c)*, FEMA will provide funding for a safe room that “is designed and sized only to the extent necessary for the limited population that must remain in the impact strike area during an extreme wind event.” This includes individuals with access and functional needs as well as those who must maintain access to the impacted area, such as first responders. The *HMA Program and Policy Guide* is updated periodically. For information on FEMA grant programs and safe room eligibility, download the most current *HMA Program and Policy Guide* from <https://www.fema.gov/grants/mitigation/hazard-mitigation-assistance-guidance>.

For island states or territories lacking vehicular access to the U.S. mainland, it is often not practical for residents to evacuate the islands to escape high winds, although it should be possible to travel within the main island to escape storm surge inundation. Observations, conclusions, and recommendations related to evacuation and sheltering challenges for Puerto Rico and the U.S. Virgin Islands are included in FEMA MAT Reports developed in the wake of the historic 2017 hurricane season. The difficulty of evacuation highlights the importance of having purpose-built safe rooms and storm shelters to provide life-safety protection for island territory residents during hurricanes. However, both FEMA P-2020 and FEMA P-2021, *Mitigation Assessment Team Report: Hurricanes Irma and Maria in the U.S. Virgin Islands (2018)*, concluded that no FEMA P-361- or ICC 500-

compliant community safe rooms or storm shelters were available to protect residents despite their limited ability to evacuate.

CROSS-REFERENCE

Information about community planning for evacuations is included in *Planning Considerations: Evacuations and Shelter-in-Place Guidance for State, Local, Tribal, and Territorial Partners* (FEMA, 2019b), which can be downloaded at <https://www.fema.gov/sites/default/files/2020-07/planning-considerations-evacuation-and-shelter-in-place.pdf>.

The installation of any safe room in a hurricane-prone region should be coordinated with local emergency management and law enforcement personnel to ensure its use during extreme-wind events is not a violation of any local or state evacuation plan.

CROSS-REFERENCE

Information about planning for vulnerable populations, including recommended travel distance limitations for intended occupants of tornado safe rooms is provided in Section A4.3.1.

In the case of approaching tornadoes, when evacuation is not possible due to limited warning times, the definition of vulnerable population is extended to include all people in buildings deemed vulnerable to failure from tornadoes.

CROSS-REFERENCE

Additional information on occupancy duration is provided in Section B7.2.1.

The capacity criteria in this publication (see Chapter B5) are defined using a minimum floor area per occupant approach to ensure that adequate space is provided for the safe room population, no matter who comprises that population. However, state and local agencies responsible for emergency management and developing and implementing evacuation plans should be consulted when identifying a population in need of protection. These plans also need to meet any applicable local, state, and federal regulations.

According to FEMA's *HMA Program and Policy Guide* (2024c), the following are the minimum components in determining the eligible safe room population:

- Population to be protected within the area at risk of impact by tornado and/or hurricane hazards

- Warning capabilities, logistics, and operations components that support basic safe room functions
- Travel times and routes for the population to be protected to reach the safe room so that people are not exposed to additional hazards when moving to the protected area
- Hazard mitigation time of protection: minimum of 2 hours for tornado and 24 hours for hurricane
- Relationship of the population to be protected by the safe room to state or local emergency evacuation requirements
- Effective and accessible warnings (alerts) that address the needs of individuals with access and functional needs and/or individuals who have limited English proficiency

For additional information on warnings, reference the FEMA document, Integrated Public Alert Warning System (IPAWS) *Alerting the Whole Community: Removing Barriers to Alerting Accessibility* (FEMA, 2013).

A2.2 Project Planning

Project planning brings together findings of the risk assessment (Section A2.1) to determine protection needs and prioritize mitigation activities. It is crucial to conduct a careful risk analysis, identify all design constraints, and prioritize all design parameters. Guidance presented in Section B3.2.3 and B3.2.4 on load combinations and non-wind load considerations, respectively, may be helpful when considering safe room design issues, especially when multiple hazards are present.

Another project planning consideration is whether the community safe room will function as a recovery shelter following the event. If this is the case, additional features will need to be added to the design of the safe room in order for it to house people once the storm has passed. These features are not currently funded by FEMA under a safe room grant. However, there are many benefits to designing and constructing a community safe room to function as a recovery shelter, including not having to move occupants and resources through a disaster-zone to another location. There may also be limited geographical areas available for construction of two different facilities—a community safe room and a recovery shelter.

Chapters A3 and A4 discuss the next steps in project planning. A decision will need to be made about whether to construct a new safe room or retrofit an existing structure before beginning the process of designing a safe room as discussed in Part B of this publication.

A2.3 Summary of Protection Options for High-Wind Events

There is an abundance of terms for different “shelters” that protect against extreme winds, but not all are created equal. Only a safe room compliant with FEMA P-361 or a storm shelter compliant with ICC 500 provides life-safety protection. Table A2-2 provides different types of “shelters” that have varying levels of protection against extreme-wind events. Several are location-specific to the State of

Florida; other states or local authorities having jurisdiction may have their own specific terminology. Any shelter (with the exception of a “recovery shelter” or “ARC 4496 shelter”) that does not meet the criteria to be a “safe room” or “storm shelter” should only be used as an intermediate solution, after conducting a risk assessment, while a FEMA P-361-compliant or ICC 500-compliant storm shelter is being built for the vulnerable population.

Table A2-2: Comparison of Shelter Terminology

Shelter Type	Description	Provides life-safety protection from extreme-wind events?	Potential for use as “intermediate” shelter while safe room is being built?
FEMA Safe Room	A building, structure, or portion thereof, constructed in accordance with FEMA P-361 and ICC 500, for near-absolute protection from tornadoes, hurricanes, and other windstorms.	Yes	N/A
ICC 500 Storm Shelter	A building, structure, or portion thereof, constructed in accordance with ICC 500, for protection from tornadoes, hurricanes, and other severe windstorms.	Yes	N/A
Best Available Refuge Area (BARA)	Building area (or areas) that has been determined by an RDP to be least vulnerable to the life-threatening effects of extreme-wind events relative to other building areas.	No	Yes
IBC Risk Category IV Building	Includes buildings and structures that, if severely damaged, would reduce the availability of essential community services necessary to cope with an emergency. Risk Category IV buildings and structures include hospitals, police stations, fire stations, emergency communication centers, and similar emergency facilities, as well as ancillary structures required for the operation of these facilities during an emergency, and facilities containing extremely hazardous materials that would threaten the public if released.	No	Maybe; depends on use and whether hazardous materials are present

PART A

Shelter Type	Description	Provides life-safety protection from extreme-wind events?	Potential for use as “intermediate” shelter while safe room is being built?
Florida Hurricane Evacuation Shelter (HES)	A safe congregate care facility that provides services and is utilized for populations displaced by an emergency or disaster event. An evacuation shelter may be located either inside (risk shelter) or outside (host shelter) of the disaster impact area and is typically operational for a period not to exceed 72 hours. Typically, these capacities are determined based on 20 square feet per person (FDEM, 2018).	No	Yes
Risk Shelter	Facilities designated as risk shelters may be located within the hazard risk zone (i.e., lie in the forecast path and associated error cone of an approaching hurricane or severe storm). Construction of these facilities meets established minimum safety requirements considered for least-risk decision-making for the community (FDEM, 2018).	No	Yes
Designated HES through assessment	Qualifying existing buildings for state-recognized shelter space requires assessing selected buildings or building areas using the American Red Cross <i>Standards for Hurricane Evacuation Shelter Selection</i> (ARC HESSS, formerly ARC 4496; 2002) and <i>ARC 4496 – Prescriptive Summary Table</i> (FDEM, 2014). Based on the survey findings, the assessor assigns a qualitative ranking—preferred, less preferred/marginal, or further investigation/mitigation required—to 15 HES criteria categories. Mitigation of any shelter vulnerability may improve the ranking of buildings under consideration.	No	Yes

PART A

Shelter Type	Description	Provides life-safety protection from extreme-wind events?	Potential for use as “intermediate” shelter while safe room is being built?
Enhanced Hurricane Protection Area (designed as)	Areas that meet the structural design provisions of the Public Shelter Design Criteria—also referred to as EHPA provisions. These provisions have evolved with the FBC; therefore, level of protection has evolved as well. Significantly, the 6th Edition FBC (2017b) includes the first reference to ICC 500. Section 453.25.4 (Structural standards for wind loads) now provides: “At a minimum, EHPA shall be designed for hurricane wind loads in accordance with ICC 500.”	No	Yes
Host Shelter	A facility that is safe and provides services and is located outside of a hazard risk zone (FDEM, 2018).	No	Yes
American Red Cross Hurricane Evacuation Shelter (ARC 4496)	A guide to assist in qualifying existing buildings or building areas for ARC-recognized shelter spaces.	No	No
Recovery Shelter	A building, structure, or portion(s) thereof, that is meant to be used once the extreme-wind event is over, where those who have been displaced from their homes can go for shelter and other basic needs.	No	No

N/A = not applicable

Chapter A3 Safe Room Economic Considerations and Benefit-Cost Analysis

This chapter addresses design- and location-based economic considerations for safe rooms and BCA. Given the large number of variables that affect quantitative community safe room costs, this chapter discusses cost in mostly qualitative terms. Guidance is primarily applicable to community safe rooms but may also be useful background information for residential safe room projects. Cost guidance specific to residential safe rooms can be found in Chapter 4 of FEMA P-320 (2024).

A3.1 Design- and Location-Based Economic Considerations

When constructing and/or installing any community safe room, the full range of potential benefits should be weighed against the immediate and long-term costs. While Section A3.2 addresses the most important safe room benefit—lives saved—the following section addresses economic considerations associated with key safe room design parameters. Section A3.1.1 discusses variable design parameters (i.e., options) that impact short- and long-term benefits and costs of the safe room. Section A3.1.2 discusses design and administrative parameters that affect initial costs and are determined based on the safe room’s location.

A3.1.1 DESIGN-BASED ECONOMIC CONSIDERATIONS

The list below addresses the potential costs and benefits of community safe room design options. Variable design parameters should be discussed with the design team during the planning phases of a safe room project in order to help the owner(s) make informed decisions based on what is most beneficial for the specific situation.

- **Single-use versus multi-use.** Whether a safe room is single- or multi-use (i.e., used for more than one purpose, not only as a safe room) can affect the initial cost (materials and labor) of building components, finishes, furnishings, and other design parameters related to the occupancy type of the safe room’s alternate (or “normal”) use. Single-use safe rooms may have simplified electrical and mechanical systems because they are not required to accommodate the normal daily needs of occupants. Another advantage of single-use safe rooms is that, when managed properly, they are not cluttered with furnishings and other items taking up floor space that might be needed in an emergency. Such clutter can be an issue with multi-use safe rooms. However, there are many long-term benefits of multi-use safe rooms. If space at a location is limited, a multi-use safe room capitalizes on space. For example, a multi-use safe room at a school may also function as a classroom, a lunchroom, a laboratory, or an assembly room (Figure A3-1). Multi-use safe rooms also allow an immediate return on investment because the safe room space is used for daily activities when it is not being used during a tornado or hurricane. Multi-use safe rooms can also help intended occupants to feel more familiar with the space and access routes, as they have been using it in other capacities. Additionally, in most cases regular maintenance is covered under the budget for the normal use of the space. Furthermore, if a safe room is designed to function with other capabilities, it may allow for use as a post-event recovery shelter, EOC, etc.

See the bullet below entitled, “Use as a recovery shelter following the hurricane and/or tornado incident,” for more information on post-event use. Not all components of a multi-purpose building designed for use as a safe room are eligible for FEMA funding. Refer to the *HMA Program and Policy Guide* for details on eligibility for FEMA funding; download the current policy and *HMA Program and Policy Guide* from <https://www.fema.gov/grants/mitigation/hazard-mitigation-assistance-guidance>.

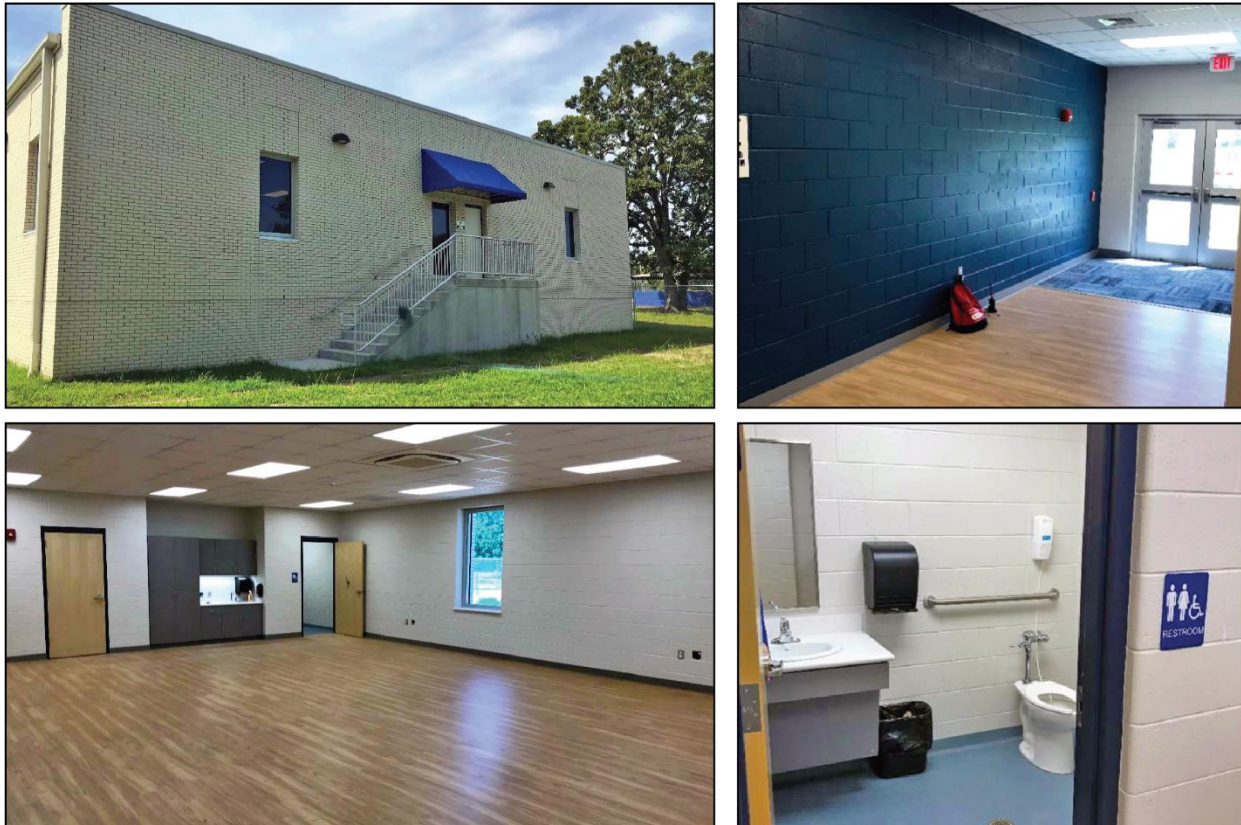

Figure A3-1: The addition to this school was designed to serve as a multi-use safe room; it is also used as a cafeteria, gym, and large-group gathering space (Climax Springs, Missouri)

NOTE

Internal Multi-Use Safe Room Considerations for Healthcare Facilities

Hospitals, assisted living facilities, and other healthcare centers are additional examples of buildings that may benefit from multi-use, internal safe rooms. For these facilities, constructing multi-use safe rooms in areas where there are occupants who cannot be evacuated rapidly, such as intensive care units or surgical suites, would provide an immediate return on investment for the safe room space. Hospitals may also need to construct additional community safe rooms for staff, patients, and visitors who may not be allowed into controlled portions of the hospital. Internal multi-use safe rooms in these types of facilities optimize space while providing near-absolute protection with easy access for non-ambulatory persons.

- **New construction vs. retrofit.** The most cost-effective way to design and construct a safe room is to include it in a new building. The cost of retrofitting an existing building (or portion thereof) is higher because of the additional design and construction constraints. These constraints can effectively require having to completely dismantle an existing portion of the building (tear down walls, dig up foundation) and replace it with new construction to meet the requirements for a FEMA safe room design. Another option is to construct a new safe room outside of the footprint of the existing building (but within the appropriate distance for the intended population). For this option, the risk for occupants from wind-borne debris leaving the host building during a storm to access another building should be considered. Land acquisition costs may also be an issue.
- **Size.** The simpler the safe room (e.g., short walls, short roof spans, minimal interior partitions and finishes), the lower the cost. Safe rooms with long-span roof assemblies and/or high walls cost more, not just because of additional materials and labor to add area and volume, but to account for the additional strength needed by the assemblies and connections to resist and transfer greater loads across longer unsupported spans. Additionally, the increased volume of conditioned space resulting from high walls requires higher-capacity heating, ventilation, and air conditioning (HVAC) systems. On top of the initial costs for upgraded HVAC, the energy usage (and therefore, long-term cost) will be higher over the lifespan of a safe room with higher walls than a safe room with standard one-story walls. However, in some cases (such as a gymnasium), the normal use of the multi-use safe room requires high walls and long-span roof members, so weighing the options for the best safe room value involves multiple interrelated considerations.
- **Number of openings in the safe room envelope.** Safe rooms and storm shelters are required to have openings for entry/egress and mechanical penetrations (e.g., ventilation, plumbing). Although common building materials are readily available for hardening wall and roof systems to make them debris impact-resistant, impact protection systems for doors, windows, vents, and other elements are costly and not as readily available. As a result, safe room costs increase as the number of openings increase. Maintenance and inspection activities also increase with each opening. Furthermore, as openings are the most vulnerable components of a safe room, having less of them provides overall better protection. Fewer openings also allows for faster activation of a safe room, as each impact-protective system requires securement (or verification if an auto-locking door mechanism is used) in order to lock-down a safe room. In a situation where every second counts, this is an important consideration.
- **Resistance to laydown or falling debris hazards.** Designing a safe room to resist laydown or falling debris loads (as discussed in Section B3.2.6.5) can increase costs. If siting alternatives are available that meet the needs of the community to be served, then consider moving the safe room outside the identified laydown radius of the laydown hazard or radius of the falling debris hazard.
- **Use as a recovery shelter following the hurricane and/or tornado incident.** If a safe room is intended to function as a recovery shelter following a hurricane and/or tornado incident, additional features will need to be added to the design of the safe room in order for it to house people once the storm has passed. As discussed in Section A3.2, there are benefits to designing

and constructing a community safe room to function as a recovery shelter, including not having to move occupants and resources through a disaster-zone to another location. There may also be limited geographical areas available for construction of two different facilities—a community safe room and a recovery shelter. This is especially true in Hawaii and the U.S. island territories. One cost impact of designating a safe room to serve as a recovery shelter stems from Section 423.2 of the 2024 IBC, which requires such buildings to comply with both ICC 500 and IBC Table 1604.5 as Risk Category IV structures. While ICC 500 wind resistance criteria far exceed wind resistance criteria for Risk Category IV structures, resistance to other hazards—seismic, snow and ice—must be higher to meet the Risk Category IV criteria. There are many examples observed by FEMA over the years that demonstrate the benefits of recovery shelters. Following Hurricane Ike in 2008, Crenshaw Elementary and Middle School (which had been elevated on concrete columns, with the bottom of the first-floor beams approximately 10 feet above grade) served as a location for emergency operations and many community meetings during the post-Hurricane Ike response and recovery period. At the time of the MAT investigation, the building was being used to house fire department personnel from other areas in Texas. These personnel provided emergency services for those involved in recovery efforts. A similar concept could be applied to a community safe room with a dual-purpose as a recovery shelter.

FEMA HMA Funds and Dual-Purpose Safe Room and Recovery Shelter

The *FEMA HMA Program and Policy Guide* is updated periodically. For information on FEMA grant programs and safe room eligibility, as well as how this guidance handles dual-purpose safe rooms and recovery shelters, download the most current policy and *HMA Program and Policy Guide* from <https://www.fema.gov/grants/mitigation/hazard-mitigation-assistance-guidance>.

- **Combined hurricane/tornado community safe room versus hurricane- or tornado-only community safe room.** The difference in cost of a hurricane- or tornado-only community safe room and a combined tornado and hurricane community safe room will vary depending on location, size, and features. But in areas where both hurricane and tornado hazards are present, safe room benefits will be greater when the safe room is designed to protect the community from both hazards. Structurally, community tornado safe rooms in U.S. states that border the Gulf and southeastern Atlantic coasts will likely have to resist higher design wind pressures and more energetic test missiles than hurricane safe rooms in the same geographic location. However, many safe room impact-protective systems are only tested and listed to the highest tornado safe room requirements. Consequently, finding components for a safe room that have been tested to the missile-impact and pressure requirements for an event other than a tornado may be difficult. From an operational standpoint, safe room support systems need to function much longer during hurricanes, as discussed below.
- **Duration of safe room support systems.** ICC 500 Chapter 7, “Storm Shelter Essential Features and Accessories,” provides minimum requirements for storm shelter support systems. The minimum duration for function of the required systems is 2 hours for tornado storm shelters and 24 hours for hurricane storm shelters. Chapter B7 of this publication does not specify duration of

function criteria for safe rooms other than referencing ICC 500. Consequently, ICC 500 governs both storm shelters and safe rooms. As described in Section B7.2.1, these durations are design minimums and are frequently exceeded during actual incidents. Prospective safe room owners are encouraged to consider the potential benefits that may be realized by increasing the duration for function of safe room support systems. The extension of critical services when municipal utilities are disabled by a storm may prove worthwhile, especially if the safe room serves occupants who need access to utilities for medical equipment. For funding eligibility of the increased costs associated with extended occupant duration, refer to the applicable program in the *HMA Program and Policy Guide*.

Hurricane Ian MAT Report Recommendation: Alternative Power Capacity Increase

Recommendation FL-47a: Owners and operators of existing Risk Category III and IV facilities that have more than one alternate power source that supplies emergency and standby systems should consider incorporating improvements to those systems that will enable critical equipment to be supplied from all available alternate power sources.

Hurricane Ian MAT Report Recommendation: Critical Equipment Powered by Alternative Power Sources

Recommendation FL-47b: Designers of new Risk Category III and IV facilities should consider redundancy in alternate power sources for critical and essential facilities that must remain operational during extended periods of loss of normal (utility) power. All emergency systems, legally required standby systems, and optional standby systems must meet the requirements contained in Chapter 7, “Special Conditions,” of the National Electrical Code (National Fire Protection Association [NFPA] 70).

A3.1.2 LOCATION-BASED ECONOMIC CONSIDERATIONS

The following section addresses established design and administrative parameters that will affect the initial cost of the community safe room. These established parameters are important factors that can impact the initial cost of a community safe room and may not be modified by design decisions, as they are tied to the location of the safe room.

NOTE

Cost Estimates

Cost estimates developed for design purposes and grant applications should be as detailed as possible to minimize delays that may occur during the grant implementation and grant review processes.

- **Safe room design wind speed.** Community safe room design wind speed is a function of the safe room storm type (tornado, hurricane, or combined) and the location where the safe room is to be sited, as outlined in Section B3.2.5. As design wind speeds increase, so do the design wind

pressures and test missile impacts that must be resisted by the safe room. As a result, the higher the design wind speed, the greater the cost.

- **Increase in cost of community safe room over minimum code compliance.** The cost differential to construct a multi-use safe room in any given location is also a function of the model building code requirements for the building's non-safe room use (e.g., school cafeteria safe room versus a school cafeteria without a safe room). The cost to construct the building will be higher in areas with higher basic wind speeds, regardless of whether it includes a safe room. Consider the following three example scenarios where a community tornado safe room is to be constructed where model building code wind provisions for non-safe room buildings vary significantly:
 - Designing and constructing a portion of a new building to resist 250 mph winds in an area of the hurricane-prone region that requires wind-borne debris protection for glazed openings in ASCE 7: This scenario involves a relatively minor cost increase above the host building cost associated primarily with the additional cost of strengthening structural elements and connections as well as enhancing envelope opening protection.
 - Designing and constructing a portion of a new building to resist 250 mph winds in the hurricane-prone region in the contiguous U.S. (elevated wind design wind speeds), but outside the areas where wind-borne debris protection is required for glazed openings in ASCE 7: This scenario involves a moderate cost increase above the host building cost associated primarily with the additional cost of strengthening structural elements and connections plus providing envelope opening protection that was not otherwise required.
 - Designing and constructing a portion of a new building to resist 250 mph winds outside the hurricane-prone region in the contiguous U.S.: This scenario involves a moderate to significant cost increase above the host building associated primarily with the cost of significant strengthening of structural elements and connections plus providing envelope opening protection that was not otherwise required.
- **Resistance to seismic loads.** Designing safe rooms to resist seismic loads may increase the cost of the safe room, and seismic detailing will be required in areas with high seismicity.
- **Permitting and administrative requirements.** Permitting and administrative requirements are site-specific and a function of where the safe room will be located. Considerations under this category include, but are not limited to, safe room construction verification requirements per the *HMA Program and Policy Guide*, safe room engineering design review requirements per ICC 500 and Chapter B1 of this publication, eligibility requirements such as pre-award costs, and the need to perform a National Environmental Policy Act–required Environmental Assessment (if required).

A3.2 Benefit-Cost Analysis

To be eligible for funding under FEMA's HMA programs, an applicant must demonstrate that a proposed project is cost effective. A BCA is used to estimate the cost-effectiveness of proposed projects.

The result of a BCA is the BCR. Mitigation projects funded under FEMA's HMA programs are required to have a BCR of 1.0 or greater (i.e., the benefits, defined as losses that are avoided, must exceed the project costs).

NOTE

Safe Room Eligible/Ineligible Costs

For information on FEMA safe room eligible and ineligible costs, refer to the *HMA Program and Policy Guide* at <https://www.fema.gov/grants/mitigation/hazard-mitigation-assistance-guidance>.

A3.2.1 SAFE ROOM BENEFIT-COST ANALYSIS SOFTWARE

Consistent with the intent of FEMA P-361 safe rooms, the reduction of injuries and deaths (life-safety benefits) are the basis for the FEMA BCA software analysis. The Tornado Safe Room BCA module and the Hurricane Safe Room BCA module are included in the current version of the BCA Tool. The most recent is the BCA Toolkit 6.0, released on July 23, 2019.

NOTE

Safe Room BCA Tool

The current Safe Room BCA Toolkit can be found at the FEMA BCA website: <https://www.fema.gov/grants/guidance-tools/benefit-cost-analysis>.

The design of the early version of the BCA software for safe rooms was based on the presumed need to fund community safe rooms that were either retrofits of existing buildings or included in a new building. Project cost inputs were based on the costs of building construction and any additional maintenance costs incurred by the project, while project benefits (avoided losses) were based on the reduction of casualties (injuries and deaths) resulting from the construction of the safe room.

A3.2.2 DETERMINING PROJECT BENEFITS

Benefits (avoided losses) are calculated as the difference between casualties that would occur without the safe room and the reduced potential for casualties after the safe room is fully operational. The casualties before mitigation (safe room construction) are determined on the basis of potential damage to different types of buildings where potential occupants would be taking refuge during the storm.

In many cases, a community safe room that is open to the public serves an off-site population. The potential safe room occupants would need to travel to the safe room from the surrounding area within the allowed time period (see Section A4.3.1 or B4.2.2.6). The methodology incorporates warning response times and travel times to the safe room in the calculation of project benefits.

The three factors used to calculate the benefits in the current software are the same as in earlier versions:

- Values associated with injury and death calculated by the Federal Aviation Administration (FAA)
- Safe room capacity (referred to as “maximum occupancy” in the BCA Toolkit) and probability of injury and death due to tornado or hurricane winds
- Probability of tornado or hurricane wind events

The way each factor is calculated in the Tornado Safe Room module is as follows:

- **Values associated with injury and death.** In 2007, FEMA convened an outside panel of building performance experts (with significant knowledge in tornado damage assessments) and life-safety experts from consulting firms, research organizations, and academia. The expert panel evaluated the existing methods for calculating benefits and recommended updated methods. As a result, the values associated with casualties are now divided into three injury levels (self-treat, treat and release, hospitalized) and death, based on updated information from the FAA, in 2019 dollars.
- **Safe room capacity and probability of injury and death due to tornadoes.** The occupant capacity load in the new software has been simplified to account for three intervals during a 24-hour period: day, evening, and night. Because most of the potential occupants of the public community safe room will come from the surrounding areas, the current methodology allows the user to select up to two before-mitigation structure types to represent the level of risk to which the potential occupants would be exposed in conditions without a safe room. The two types can be selected from eight pre-defined structure types provided in the model, which are based on the DIs used in the development of the EF Scale (see “Wind Speed Estimation Standard” textbox in Section A2.1.1.1). The casualty rates for each damage state were defined on the expected Degree of Damage (DoD) of each Damage Indicator (DI) given a wind speed in the EF Scale (TTU, 2006). The hurricane safe room module only requires information on the predominant structures where the occupants would normally take shelter and the percent of the occupancy attributed to the first and second predominant structures.
- **Probability of tornado events.** In the current software, the probability of a tornado striking a safe room is based on NOAA’s historical tornado records. NOAA keeps tornado records with recorded paths or start and end points covering the period from 1950 to 2016. This information was used as part of a geospatial analysis, based on tornado probability research, to produce tornado occurrence maps for each EF Scale rating (EF1–EF5). In the current software, tornado probability is calculated using published average national tornado length and width values. When the user

selects the county where the safe room will be located, the pre-calculated tornado probabilities are accessed from the software database.

- **Probability of hurricane winds.** The current version of the Hurricane Safe Room module uses ASCE 7 wind speed maps to determine the potential risk of hurricanes at the safe room location. The current maps are made available through the Applied Technology Council Hazards by Location website. The BCA software associates these resulting wind speeds with the number of injuries and deaths predicted using the 2007 FAA data for the building without a safe room. The calculated numbers of injuries and deaths are then compared with the reduced probability for injuries and deaths resulting from the construction of a safe room. The probabilities for various types of injuries or fatalities are then multiplied by the FAA values updated for 2019.

The Tornado Safe Room and Hurricane Safe Room BCA modules were developed to provide a defensible and user-friendly way to calculate life-safety benefits for community and large residential tornado and hurricane safe rooms. To streamline the HMA grant application process, FEMA has also released several benefit-cost efficiencies to provide pre-determined cost-effectiveness values for residential safe rooms. Using pre-calculated benefits from similar past safe room projects eliminates the requirement for Applicants to conduct a separate BCA for eligible projects. One such project is “Residential Tornado Safe Rooms.” Guidance for this project type can be accessed at <https://www.fema.gov/grants/guidance-tools/benefit-cost-analysis/streamlined-bca> (see the table under the “Pre-Calculated Benefits Resources” subheading to find where individual program information is located within the current *HMA Program and Policy Guide*). The pre-calculated benefits and benchmark costs are not intended to drive actual project costs or to serve as detailed project cost estimates; individual project cost estimates must be based on industry standards, vendor estimates, or other acceptable sources. If pre-calculated benefits are applied during the application phase of the project, the project still must remain cost-effective once actual project costs are determined. Projects must still meet all other HMA requirements, and a copy of the data relevant to the project location must be submitted with the project application.

This page left blank intentionally

Chapter A4 Operations and Maintenance Considerations for Community Safe Rooms

This chapter describes the O&M considerations for community safe rooms. O&M for residential safe rooms is not discussed in this chapter, though owners of a safe room may find some of the information pertinent. For information on operating and maintaining residential safe rooms, please refer to Section 6.2 of FEMA P-320 (2024).

Disaster preparedness is crucial for quick and effective responses during emergency situations. Accordingly, every community safe room should have an O&M plan that is reviewed and updated on a regular basis to be ready for efficient and effective activation when needed. This chapter discusses some factors that should be considered when developing an effective O&M plan.

When determining how to optimize emergency management performance for a community safe room before, during, and after a hurricane or tornado, communities should have reasonable flexibility to implement management practices that are appropriate for their local area, as well as meet any requirements by the authority having jurisdiction. The purpose of this chapter is to help communities identify issues requiring careful consideration and planning so they can find appropriate solutions tailored to their specific needs. Providing a one-size-fits-all set of criteria for operating and maintaining safe rooms everywhere in the United States would not be appropriate. For example, urban, suburban, and rural areas typically have different modes of transportation, communication, and local resources, all of which should be considered specifically when preparing an effective O&M plan. FEMA provides sample O&M plans on its safe room website at <https://www.fema.gov/emergency-managers/risk-management/building-science/safe-rooms/resources>; these sample plans can be used as a starting point for creating tailored community plans for new safe rooms.

The O&M plan should provide details on safe room parameters (Sections A4.1), operational components (Sections A4.2 through A4.7), and maintenance components (Section A4.8). Many of the O&M plan operational components address preparation of the safe room for initial use and extend to maintaining a state of preparedness to efficiently function when the community is threatened by a tornado or hurricane. Guidance on O&M plan operational components in this chapter include staffing and personnel roles and responsibilities (Section A4.2), notification procedures for potential occupants (Section A4.3), emergency provisions (Section A4.4), access and entry (Section A4.5), operational procedures during an event (Section A4.6), and post-event operations (Section A4.7).

NOTE**FEMA Safe Room Funding Requirements**

Safe rooms constructed with FEMA grant funds must meet the minimum requirements for O&M plans as described in FEMA's *HMA Program and Policy Guide*. The *FEMA HMA Program and Policy Guide* is updated periodically. To review or download the most current *HMA Program and Policy Guide*, refer to <https://www.fema.gov/grants/mitigation/hazard-mitigation-assistance-guidance>.

The *HMA Program and Policy Guide* provides information on HMA eligibility and covers implementation issues such as eligible and ineligible costs, recognized design standards, and other important considerations. To be considered for funding, community safe room project applications must include a written statement acknowledging that the requested community safe room will be operated and maintained in a manner that achieves the proposed hazard mitigation. O&M plans are not required for residential safe rooms.

Safe room owners and operators may want to incorporate safe room measures above what is required by FEMA HMA or best practices and guidance provided in Chapter A4 of FEMA P-361. While certain items may not be eligible costs, they should still be considered. Examples include standby power for items not required to have back-up power per ICC 500, additional technology and/or communications devices not required by ICC 500, a control room, functional and access needs beyond those required by FEMA P-361, or medical equipment needs beyond first aid. Some additional design considerations include mechanical versus natural ventilation and permanent versus temporary plumbing fixtures.

NOTE**ICC 500 Appendix A: Storm Shelter Preparedness and Emergency Operations Plan**

As described in Section B1.2.5, ICC 500 requires all community storm shelter owners to submit a preparedness and emergency operations plan to the authority having jurisdiction. In conjunction with the administrative requirement, Appendix A provides minimum requirements for the Storm Shelter Preparedness and Emergency Operations Plan (SSPEOP). ICC 500 appendices are only mandatory where specifically adopted by the authority having jurisdiction, but ICC 500 Appendix A may serve as a template for the development of a preparedness and emergency operations plan. The ICC 500 Appendix A requirements may be more detailed than O&M plan requirements in the *HMA Program and Policy Guide*, so FEMA recommends that where ICC 500 Appendix A has been adopted, safe room applicants work with state and Regional FEMA grant personnel to ensure compliance with both HMA policy and locally adopted codes.

A4.1 Safe Room O&M Plan Objectives and Parameters

Owners and operators of tornado and hurricane safe rooms should be ready and able to activate and open the safe room for immediate and efficient use in response to an impending tornado or hurricane. The best way to accomplish this is twofold: (1) create an effective plan adapted to the needs of the intended occupants of the facility, and (2) provide redundancy for critical responsibilities.

More Information

Sample O&M plans can be found under “Legacy and Historical Information” at <https://www.fema.gov/emergency-managers/risk-management/building-science/safe-rooms/resources>.

NOTE

Annual Review

O&M plans should be considered to be working documents. As such, they should be reviewed and updated regularly, at least every year and after an activation for lessons learned.

The O&M plan should identify how the safe room will be activated, operated, and maintained in a way that achieves the objective of providing life-safety protection from a tornado or hurricane given the expected warning time and duration for the event. Preparation of the safe room for use is a major part of the operations components; this level of preparedness must be continually maintained. If the community safe room is a combined safe room (i.e., designed to provide life-safety protection from both hurricanes and tornadoes), the O&M plan should cover both storm types whenever different measures apply.

The development of an O&M plan should be coordinated with the appropriate entities using and operating the community safe room and should be signed by the appropriate officials in these organizations.

Before developing the safe room operational and maintenance components of the O&M plan, the safe room parameters addressed by the following sections (Section A4.1.1 through Section A4.1.4) should be clearly defined by the safe room owner and operator and other stakeholders. FEMA recommends including basic safe room parameters in the O&M plan so that safe room staff, emergency management, and future safe room owners understand the limitations of the safe room and the rationale for the plan’s operational and maintenance provisions.

A4.1.1 SAFE ROOM DESIGN

The siting, size, and design occupant capacity, configuration, access points, support areas, and many other aspects of the design will greatly influence the O&M of the safe room. Therefore, understanding the issues raised in this chapter and considering how the O&M plan can best address them, along with any other location-specific issues, is important for all stakeholders (e.g., owner/operator, planners, designers, community). **BEST PRACTICE: FEMA also recommends that a floor plan of the safe room be included in the O&M Plan, as well as additional information on the host building, if applicable.**

A4.1.2 MULTI-USE VERSUS SINGLE USE

O&M plans should include steps to ensure safe room readiness. The approach outlined will vary as a function of whether the safe room is single- or multi-use. Single-use safe rooms are intended to be occupied only during an extreme-wind event, whereas multi-use safe rooms are designed to serve as functional space for other uses such as offices, classrooms, or a gymnasium (as shown in Figure A4-1) when not needed as a safe room. Multi-use safe room O&M plans need to demonstrate that normal daily usage of the space will not interfere with timely safe room operations. O&M plans for single-use safe rooms should demonstrate that readiness will be maintained through measures designed to prevent the safe room from being misused or neglected. For example, using the safe room for storage decreases usable floor space and occupant capacity.

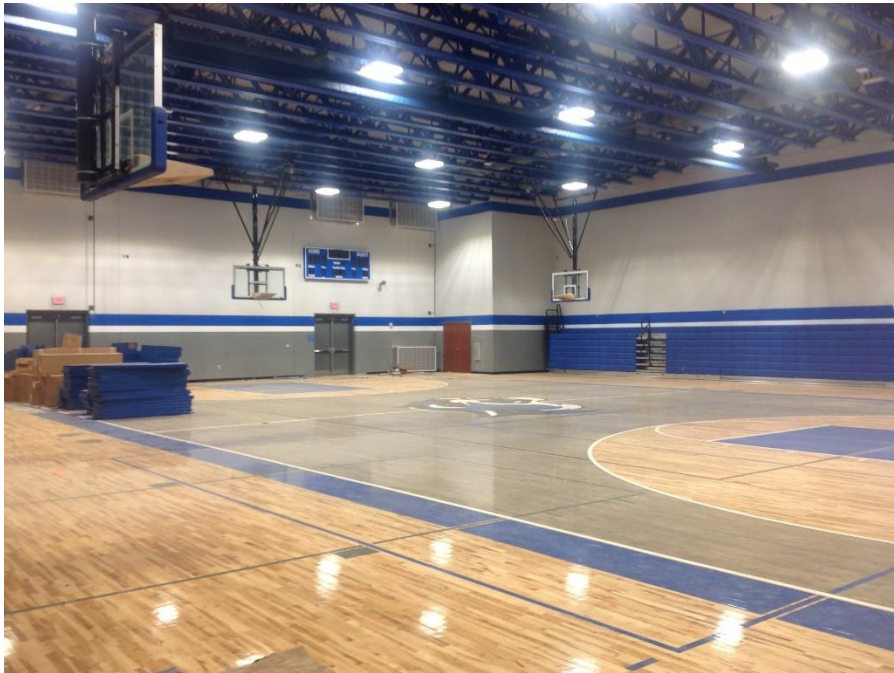

Figure A4-1: Example of a multi-purpose safe room also used as a gymnasium

For additional considerations regarding multi-use community safe rooms, including dual-use as a recovery shelter following an event, refer to Section A3.1.1.

A4.1.3 DURATION OF OCCUPANCY

The anticipated duration of safe room occupancy also drives O&M considerations. Safe rooms are different from other types of shelters in that, unless otherwise designated (e.g., also to be used as post-incident recovery shelter), they are designed to safeguard people only during windstorm incidents. In accordance with ICC 500, FEMA considers this to be a minimum of 2 hours for tornadoes and a minimum of 24 hours for hurricanes. However, as described in Section B7.2.1, it is not unusual for tornado or hurricane safe rooms to be occupied longer than the minimum period of occupancy. For funding eligibility of the increased costs associated with extended occupant duration, refer to the applicable program in the *HMA Program and Policy Guide*.

The longer duration of occupancy for hurricane safe rooms and combined safe rooms demands additional considerations related to occupant needs. As a result, O&M plans for community hurricane safe rooms usually need additional roles, responsibilities, supplies, and services. Where relevant, the discussion in this chapter addresses the differences between tornado and hurricane considerations.

EXAMPLE

Extended Warning Times

On April 27, 2011, occupants spent most of the day at a community safe room in Brookwood, Alabama. The town was in the warning areas for the tornadoes that day but was not directly struck. Because the safe room was in the town park, most residents who used the safe room drove there on the day of the event. Town officials stated that the safe room was filled to “standing room only” for a good portion of the day (FEMA, 2012).

A4.1.4 INTENDED OCCUPANTS

The characteristics of the intended safe room occupants (known or unknown) will significantly affect planning, design, and O&M considerations. For example, a school safe room that is intended for students and staff will require different design and O&M considerations than a safe room that is intended for first responders, pump station operators, hospital patients, retirement home residents, or the general public. Consequently, every safe room design and O&M plan must be tailored to the anticipated needs of the intended occupants to maximize its effectiveness.

The remainder of this chapter discusses safe rooms from the following two different occupancy considerations:

- **Safe rooms open to the general public.** All safe rooms, including those open to the general public, are designed to accommodate a maximum number of occupants and are sited to protect a designated population. O&M plans for safe rooms open to the general public should anticipate health, security, and other possible situations that may arise when occupants unknown to each other and to safe room operators congregate in limited safe room spaces. Because occupants

are not already on-site—as is typical with safe rooms for specific occupants—sufficient parking should be available for the intended number of occupants expected to arrive by automobile.

- **Safe rooms for specific occupants.** Safe rooms intended for specific occupants must be designed and sited in accordance with the needs of the intended occupants; all occupants need to be able to travel to and access the safe room within a reasonable amount of time. Similarly, O&M plans for safe rooms intended to protect only a specific set of occupants should be tailored for the needs of the intended population; the O&M plan should be able to accurately address the needs (medical, accessibility, security, parking, etc.) of the defined set of occupants.

NOTE

School Safe Rooms

Due to limited capacity and/or safety concerns for students, some school community safe rooms are not open to the general public or are made open only when school is out of session or during evening and overnight hours. To determine whether and when a school safe room is open to the general public, potential occupants should check with the school or school district as early as possible to avoid being denied admission when an extreme wind event is imminent.

EXAMPLE

School Community Safe Rooms and Intended Occupants

Following the 2011 tornado, all new Joplin, Missouri, school safe rooms are being designed to accommodate not only the students, faculty, and staff of each school, but also the residents who live nearby. Each will have an average capacity of 1,000 to 1,500 people. Operational considerations will need to be different for use during school hours and for use when school is not in session.

“The safe rooms are designed for that general radius around each school,” according to Jason Cravens, Executive Director of Secondary Education (Youker, 2014).

This breakdown—general public versus specific occupants—represents a starting point for considering emergency management practices for safe rooms but does not encompass all potential factors to be considered. For example, a school safe room may be intended only for the students and staff of the school (making it a safe room for specific occupants), or it may also be intended to serve nearby residents and therefore falls into both categories (general public and specific occupants). The O&M plan for every safe room should address the anticipated occupancy conditions. There could be specific-use situations for each safe room that would need to be addressed separately. For example, a community safe room at a school may be run by school staff during school hours and people not associated with the school after hours.

The determination of who is allowed to use a safe room is made by the building owner and a discussion of this topic is outside the scope of this publication. However, many communities have recognized the value of safe rooms for saving lives and have sought to achieve optimal occupancy to target populations by enabling accessibility 24 hours a day, year-round.

Some aspects of planning necessary for very-high-capacity safe rooms that may be required in large, public venues (such as stadiums or amphitheaters) are beyond the scope of this publication. Although an owner or operator of such a venue should follow the applicable requirements presented in this publication, detailed guidance for operational considerations of very-high-capacity safe rooms is not provided in this publication. See Sections A1.1 and B5.2.1 for additional information.

NOTE

Additional Considerations for the Movement of Occupants to Hurricane Community Safe Rooms

When developing plans for hurricane community safe rooms, designers should consider other hazard-specific constraints that may be governed by local emergency management or law enforcement requirements, mandatory evacuations, and other related emergency plans that affect the movement of at-risk populations.

For some communities, when there is sufficient warning time, a large proportion of the population may be expected to leave the area of anticipated immediate impact and seek shelter outside the at-risk area. However, people such as first responders and those who are physically unable to leave the area would remain in harm's way. Therefore, for hurricane hazards, FEMA only considers providing grant funding for extreme-wind mitigation projects that are designed for populations that cannot remove themselves from harm's way during a hurricane. For more information on vulnerable populations, evacuation, and special considerations for island populations without vehicular access to the U.S. mainland, see Section A2.1.2.2.

To obtain the current FEMA guidance on safe rooms, contact your FEMA regional office, or review and download the latest *HMA Program and Policy Guide* from here:

<https://www.fema.gov/grants/mitigation/hazard-mitigation-assistance-guidance>.

A4.2 Staffing and Personnel Considerations

Once safe room objectives and parameters have been defined and the considerations described in this chapter have been reviewed, safe room roles and responsibilities can be identified in the O&M plan. Contact lists allow the identified staff to stay connected with each other and quickly find both emergency and non-emergency phone numbers. Ensuring that staff and personnel will be equipped with the resources and knowledge for each task they need to complete during an event is essential for the effective operation of a safe room. These roles need to be clearly defined and those assigned to the roles need to be properly trained. Furthermore, if the safe room is to be occupied for a long time, work shift procedures may need to be developed prior to an event. The following subsections

describe these staffing and personnel considerations. Each personnel role should have a backup person able to perform the duties should the primary person be unavailable.

A4.2.1 ROLES AND RESPONSIBILITIES

Identifying and describing specific roles and responsibilities is a primary objective of the O&M plan. The roles required for adequate functionality and orderly use of the safe room will vary depending on the hazard type, safe room occupancy and capacity, access and functional needs, multi-use space usage, and other factors. Given this variability, no list of roles is provided in this guidance. However, sample O&M plans can be found at FEMA's website: <https://www.fema.gov/emergency-managers/risk-management/building-science/safe-rooms/resources>. Roles and responsibilities can also change depending on the time of day and day of the week; each O&M plan should be customized and consider all possible scenarios.

Having personnel assigned to the full range of O&M tasks and responsibilities before any safe room ever opens is critically important. Each role should include specific responsibilities to be performed before, during, and after the event. Backup personnel should also be identified in case the assigned person is absent or unable to complete his or her duties. The list of tasks to be completed and the list of people who perform each task will vary between safe rooms as a function of the safe room's unique characteristics. Roles should be identified by role or title instead of by name in the plan because assignments will likely change over time as individuals leave the organization or community. Periodically, the staffing and personnel list of duties should be evaluated and adjusted as needed for future incidents.

A4.2.2 CONTACT LISTS

Once primary and backup personnel are identified and assigned, the O&M plan should contain or reference a list of all current phone numbers and email addresses for each, and a copy should be kept in the safe room at all times. When referenced externally by the O&M plan, the contact list may be updated and re-circulated more efficiently than through revision of the entire O&M plan. Full contact information (i.e., home, work, and cell phone numbers and work and personal email addresses) for each person assigned a role and his or her designated backups should be provided for all safe room personnel as well.

NOTE

Registering the Safe Room

Once the safe room is constructed or installed, it should be registered with local first responders (e.g., police, fire, rescue organizations). Registration information should facilitate search and rescue operations following an event, which is especially important if safe room occupants become trapped by debris blocking the safe room door. For this reason, coordinates to the safe room main entrance should be provided in the registration information.

Some cities and counties provide websites for owners and operators to register their safe rooms. Safe room owners should contact local authorities for information on the best way to register in their area.

The O&M plan should include a current list of all emergency contact numbers. A copy of the list should be kept in the safe room. The following is a suggested list of the agencies/numbers that should be included:

- Emergency management contacts for the building
- Local fire department (both emergency and non-emergency numbers; any radio frequencies)
- Local police department (both emergency and non-emergency numbers; any radio frequencies)
- Local emergency medical services (EMS) (both emergency and non-emergency numbers; any radio frequencies)
- Local EOC (both emergency and non-emergency numbers; any radio frequencies)
- Appropriate security and medical personnel that can support the safe and effective functioning of a larger community safe room (refer also to Section A4.6); O&M plans may designate contacts in the local police force and EMS agencies to support this function
- Local utilities (e.g., gas, electric, water, telephone)
- Emergency contractors (e.g., electrical, mechanical, plumbing, fire alarm and sprinkler service, window replacement, temporary emergency windows, general building repairs)
- Any services pertinent to continuation of operations for the organization(s) or company(ies) occupying the building (e.g., catastrophe preparedness unit, company cards, communications, mail center, maintenance, records management, purchasing/supply, data processing)

A4.2.3 STAFF TRAINING

Personnel training and drills should be conducted to ensure the operations of the safe room will run smoothly during an emergency. Personnel need to know all warning signals used, including the difference between a watch and a warning, what they mean, what responses they trigger, and when activation of the safe room should occur. This information should be emphasized in the O&M plan and reiterated through training so that it is retained and easily accessible for reference. Multiple levels of redundancy can ensure that each task will be covered if the primary person is unable to perform their duties at the time of activation. Personnel assigned to safe rooms in schools need to know what to do differently during school hours versus after school hours. If it is a combined safe room for hurricanes and tornadoes, then training needs to be provided for both types of hazards. After training, all personnel should be thoroughly familiar with the O&M plan; this includes all staff on each list if a safe room has different staffing depending on hours or days of the week.

Hurricane Ian MAT Report Recommendation: Annual On-Site Trainings

Recommendation FL-40a: Florida shelter (HES, EHPA, safe room, and storm shelter) operators should conduct a yearly on-site training at each shelter. Training participants should include the main point of contact person/people operating the shelter and building owner representatives. The training should include a review of roles and responsibilities, area layout, and critical support systems. FEMA P-361 (Section A4.2.3) and ICC 500 (Section A105) should be referenced as guidance for developing a training plan.

Hurricane Ian MAT Report Recommendation: Operation & Maintenance (O&M) Plan

Recommendation FL-40b: Florida shelter (HES, EHPA, safe room, and storm shelter) owners and operators should have their own O&M plan that is reviewed and updated on at least an annual basis. FEMA P-361 (Chapter A4) and ICC 500 (Appendix A) should be referenced as guidance for developing an O&M plan, even when the facility is not a safe room or storm shelter. Conducting a yearly on-site training at the shelter should be included in the O&M plan.

O&M plans should clearly define primary and backup roles for monitoring NWS alerts on days when severe weather is forecast or otherwise anticipated. Further, the plans should include all safe room staff activation trigger points, including but not necessarily limited to NWS tornado or hurricane watches and warnings, which are provided below with staff response guidance for consideration.

Terminology

Watch: A tornado watch is issued when conditions are favorable for a tornado to form.

Similarly, a hurricane watch is issued by the NWS when a hurricane is possible in a given area. A hurricane watch is issued 48 hours in advance of the anticipated onset of tropical-storm-force winds.

Warning: A tornado warning is issued when a tornado is either occurring or is imminent based on weather radar.

A hurricane warning means that hurricane conditions are expected in the specified area. The warning is issued 36 hours in advance of the anticipated onset of tropical-storm-force winds.

Tornado or hurricane watch responses

When a watch is issued, the safe room staff should be placed on alert. The plan should specify the types of activities to be performed for each contingency depending on the type of safe room, the impending emergency, the timing of the watch announcement, and the availability of personnel responsible for safe room operations. Staff responsible for actions that should be completed before occupants arrive should be activated in advance of the warning; this is particularly important to ensuring effective operations. For example, a stand-alone tornado community safe room in a

residential neighborhood should be opened and prepared for a possible emergency during this early stage.

Tornado or hurricane warning responses

When a warning is issued, the safe room staff should begin performing the tasks triggered in the O&M plan. For example, a tornado warning may serve to trigger additional staff to assist late arriving occupants or others to be in position to secure individual impact protective systems. With longer warning times for hurricanes (reference “Terminology” textbox above), the issuance of a hurricane warning may serve to finalize preparation of the safe room and begin registering occupants for sheltering.

A4.2.4 WORK SHIFTS

For hurricane safe rooms or anticipated long duration incidents, assigning certain roles to several individuals may be necessary so that people can be relieved of responsibilities at the end of a designated time period or shift. Additional safe room management responsibilities may include coordinating role transitions when a new work shift begins or as otherwise needed because of fatigue or health-related issues.

A4.3 Community Outreach and Notification

Community safe room owners and operators should alert potential occupants of the presence and location of the safe room, procedures to access the safe room (via mass mailings, meetings, flyer distribution, and drill exercises), any new or changing policies, and general information such as the safe room pet policy. The recommended pre-incident notification considerations described in this subsection are not intended to be exhaustive. Sending out a survey to potential occupants is advisable to identify any medical or special needs they may have (refer to Section A4.3.4).

A4.3.1 IDENTIFYING POTENTIAL SAFE ROOM OCCUPANT POPULATION AND PROVIDING INFORMATION

Whether open to the general public or occupant-specific, all safe rooms are designed with maximum capacities and therefore protect a specified “at-risk” population. All potential occupants of a safe room should be notified of the safe room location and policies related to its use. Confusion about who may use a safe room can result in overcrowding, or worse, people being unable to access it due to overcapacity or the safe room doors having been locked to meet operational requirements.

CROSS-REFERENCE

Refer to Section B4.2.2.6 for tornado safe room travel time restriction guidance that has been adapted from the *HMA Program and Policy Guide*. Section A2.1.2.2 of this publication also includes guidance on tornado and hurricane safe room population limits for FEMA grant eligibility.

Potential users in a community should be informed of the community's emergency plans well in advance of an event and should be prepared to seek refuge in their pre-assigned safe room. Neighborhoods that operate community safe rooms are encouraged to conduct regular exercises to test their operational preparedness and acquaint potential occupants with the safe room.

Furthermore, any policies regarding pets should be made known to the intended occupants (refer to Section A4.3.6).

For tornado safe rooms only intended for the portion of the public that falls within a given tornado protection (or intended occupant) zone (see Figure A4-2), safe room operators may consider coordinating with local officials to develop community-wide strategies for tornado protection awareness. This approach may prevent confusion and overcrowding. Figure A4-2, which illustrates an example tornado protection zone, indicates a $\frac{1}{4}$ -mile radius for occupants walking to the safe room; a $\frac{1}{2}$ -mile travel distance typically applies to occupants driving to a community safe room. For most adults, a 5-minute walking distance is about $\frac{1}{4}$ mile (1,320 feet). Whether walking or driving to a tornado safe room, anticipated travel time is the limiting factor for where the safe room can be sited, and while a safe room may be intended to serve occupants within a specific radius, travel time to the safe room depends upon the path prospective occupants take to reach the facility. Therefore, informing residents of the best travel routes to the safe room location and providing corresponding signage is advisable. Where intended occupants are coming from nearby buildings (e.g., school or hospital campuses with multiple buildings), a minimum distance of 1,000 feet between occupant-source buildings and the safe room entrance is recommended to allow time for egressing the occupant-source buildings.

Tornado community safe room owners and operators should also consider that visitors may be onsite (such as school volunteers or visiting sports teams) that could potentially need to use the safe room while visiting.

Tornado Protection Zone Map

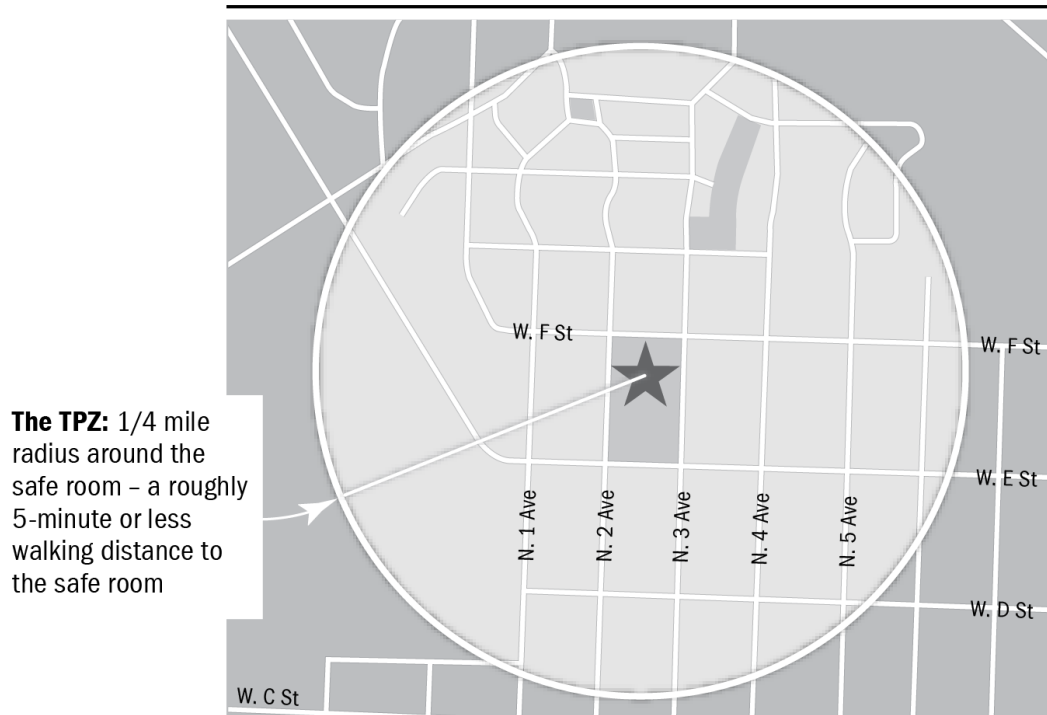

Figure A4-2: Example of a tornado protection zone map for a safe room intended to serve a specific protection (or intended occupant) zone

Hurricane safe rooms are usually designed and built to provide life-safety protection for first responders and critical and essential services personnel and facility occupants. In such cases, community outreach for hurricane safe rooms should inform the community that the safe room is intended for specified “at-risk” groups only and that all mandatory evacuation orders should be followed. Also, communities that intend potential occupants to bring sufficient food to last the anticipated duration of the hurricane should provide this information to the intended occupants well in advance of the hurricane.

A4.3.2 SIGNAGE

Placing information signs in clearly visible locations is important to alert communities to the presence of a safe room. Signage should include the intended occupants and maximum capacity of the safe room, the travel routes to the safe room, the location of the safe room entrance door, and other pertinent details. Depending on the population served, posting signs in languages other than English may be necessary.

Safe rooms open to the general public

Signage is critical for occupants to be able to readily find and enter the safe room, especially when a safe room is inside a larger building (see Figure A4-3 for an example of a sign). In addition to directing potential occupants to the safe room, signs can also identify the area the community the safe room is intended to serve, as shown in Figure A4-2, and can be posted to show the best travel

routes to the safe room location. Signs can also inform the residents of the neighborhood served by a safe room about the capacity limitations during any given event. Refer also to Section B5.2.8 of this publication for additional information on signage, as well as the changes for signage made to ICC 500-2023.

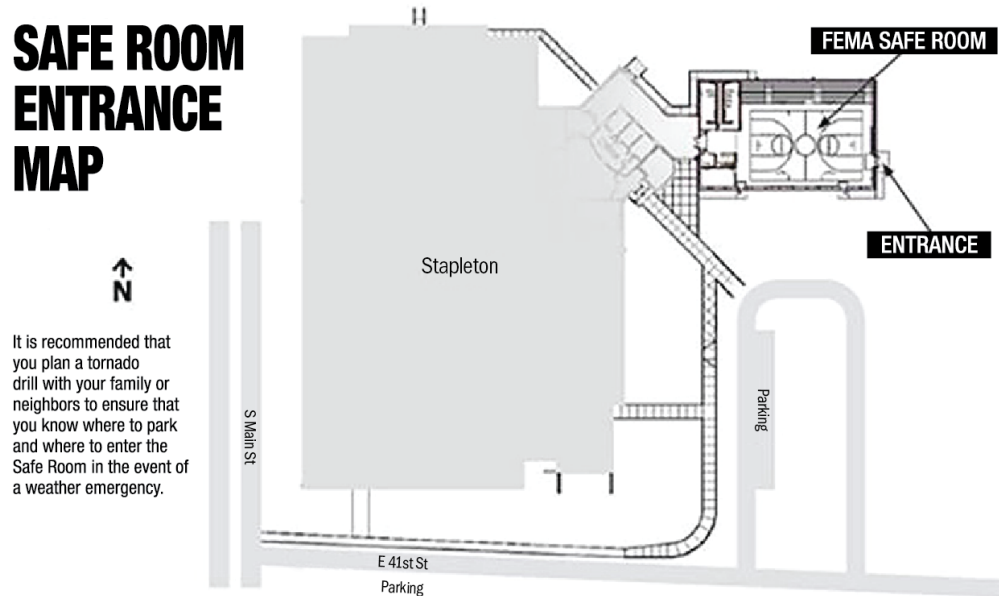

SOURCE: JOPLIN SCHOOL WEBSITE, https://stapleton.joplinschools.org/58774_2

Figure A4-3: Example of a sign showing location for safe room entrance

Safe rooms for specific occupants

The presence of safe room signage on the outside of a building can easily cause surrounding residents to assume they may use the safe room during a tornado, even when the safe room is designated for use solely by the occupants of the building, such as at a school, hospital, or private business. This unintentional miscommunication may be mitigated through community outreach and carefully placed and specifically worded safe room signage. Because signage is required at all safe room entrances, special consideration of exterior wall safe room door locations is recommended during the pre-design phase (i.e., ideally not facing a public right-of-way when not open to the general public).

A4.3.3 EXPECTATION OF SAFE ROOM USE DURING OFF HOURS

Safe rooms for specific occupants

It is important for safe room owners and operators to clearly indicate to potential safe room occupants when the facility will be open. For example, will the safe room at a school be accessible after the regular school hours? At places of business, will the safe room be accessible after normal work hours? At hospitals, can employees bring their families into the hospital safe room? These types of questions should be answered by the owner/operator, specified in the O&M plan, and clearly communicated to potential occupants.

NOTE**Off-Hour Use**

Safe room owners and operators should notify intended occupants of a safe room as to when the safe room is or is not available for use. For example, a school may decide their safe room is only for students and faculty use during school hours but will be available to the surrounding community after school hours. Whatever policy is adopted, it should be clearly communicated to the community.

A4.3.4 INFORMATION ON THE SPECIAL ACCOMMODATION NEEDS OF POTENTIAL SAFE ROOM OCCUPANTS

Some community safe room operators choose to distribute information request forms to assess special accommodation needs (e.g., refrigeration for medications, power supplies for medical equipment, service animals, etc.) of potential occupants. The information gathered can be used to prepare for the level of health care that may be needed from the designated first aid or health services staff.

If the above-described approach is taken, then the responders' special accommodation needs information should be maintained as part of the O&M plan and updated on a regular basis. All information gathered through information request forms should be compiled and made available to appropriate safe room personnel for use during a high-wind event. Where safe room staff register arriving occupants, this information can be used to notify personnel responsible for first aid and health services, as needed.

A4.3.5 ALERT SIGNALS AND DRILLS

Potential safe room occupants should be informed of the community's emergency plans well in advance of an incident and should be prepared to seek refuge in their pre-assigned safe room. It is extremely important that prospective safe room occupants recognize and understand the distinct warning signal that calls for them to proceed to the safe room. As noted in Section A2.1.2.2, warnings signals should be developed to reach the whole community, including individuals with access and functional needs and/or individuals who have limited English proficiency.

Neighborhoods that operate community safe rooms are encouraged to conduct regular exercises to test their operational preparedness and acquaint potential occupants with the safe room activation procedures. In schools, workplaces, hospitals, and similar areas with regular occupants, storm refuge drills should be conducted (at least annually; however, more drills are recommended to avoid complacency) to test the effectiveness of the O&M plan. Such drills will also test the signage, accuracy of contact information, knowledge of procedures by those enlisted with roles to perform, and the ability of the intended occupants to get to the safe room within the time limits. Any deficiencies found during the performance of these drills should be addressed in the O&M plan to improve the response. Drilling and training should be the responsibility of the safe room owners and operators or governing organization.

Clearly defined routes, which should be utilized during drills, should be identified for safe room occupants as shown in Figure A4-4. Identified routes should be easily navigated and free of hazards (refer also to Section B4.2.2.6). The route(s) also need to meet any applicable local, state, and federal regulations, and should be adequately and appropriately coordinated with state and local emergency operation plans.

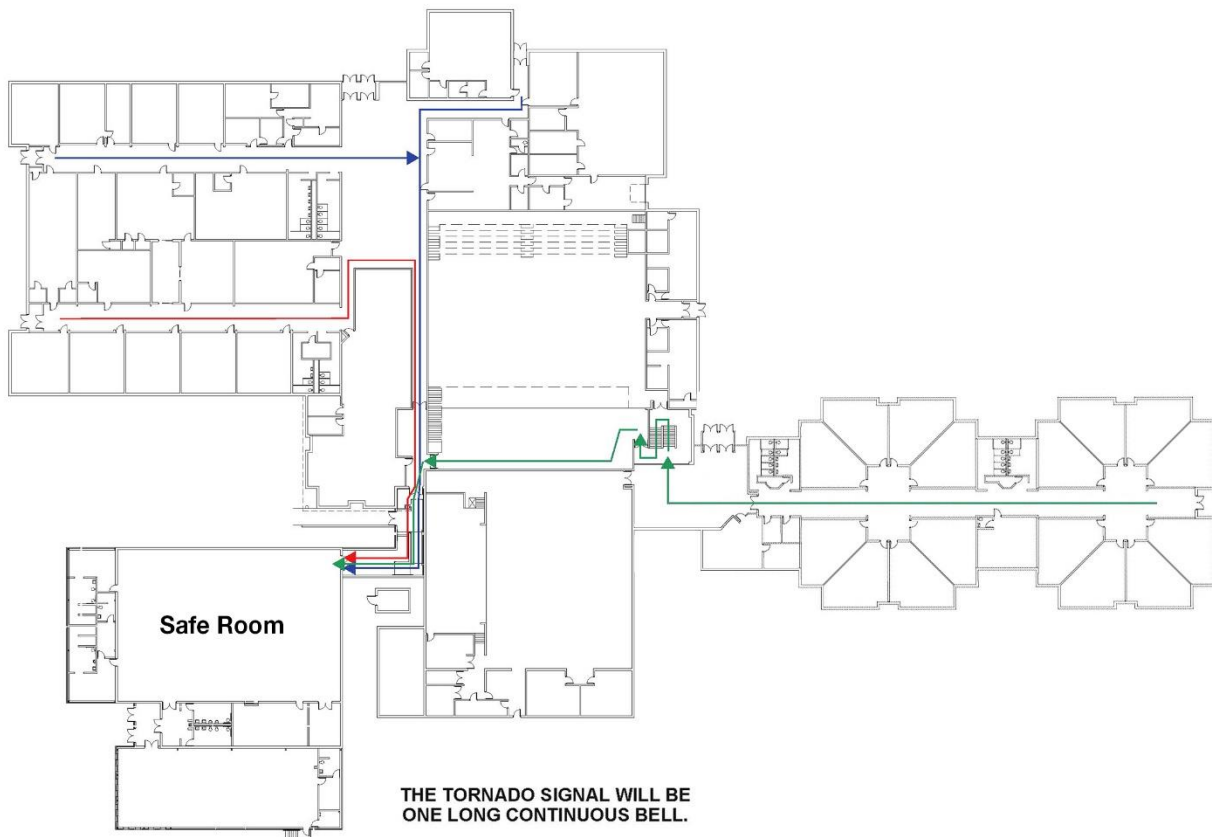

SOURCE: ADAPTED FROM HOLLISTER R-V SCHOOL DISTRICT, 2013

Figure A4-4: Example of a site plan clearly identifying safe room access routes

A4.3.6 PETS

Many people do not want to leave their pets during a storm. However, tornado and hurricane safe rooms are typically not prepared to accommodate pets. The policy regarding pets in a community safe room should be clearly stated in the O&M plan and be communicated to prospective occupants through public outreach to avoid misunderstandings and hostility when individuals arrive at the safe room. While some safe rooms allow pets confined in owner-provided, airline-approved carriers, many safe rooms allow only service animals. As described in Section A4.3.4, safe room operators may wish to identify the potential number of service animals the safe room may need to accommodate by distributing access and functional needs request forms to those within the safe room protection zone.

NOTE**Securing Pets During High-Wind Events**

When pets are not allowed in community safe rooms, some residents adapt by kenneling pets and moving them to the safest area in their home before evacuating to a safe room. If this course of action is chosen, pet owners should practice and drill this procedure to ensure that they can complete this action and still reach the safe room within 5 minutes of an alert.

If a safe room owner or operator chooses to provide protected space for pets, operational plans should be developed and coordinated with designers so any requirements for the specific types of animals expected at the safe room can be met. Special accommodations for the animals might include separation distances, readily cleanable areas with drainage, a quarantine area for sick animals, more space depending on the sizes of the animals, etc.

A4.4 Emergency Provisions

Emergency provisions needed vary for different storm types. In general, emergency provisions will include food and water, communications equipment, and emergency supplies. Safe rooms serve a different function than long-term recovery shelters; however, safe room managers may elect to provide supplies that increase the comfort level of safe room occupants. For additional information, refer to Chapter B7, especially Sections B7.2.4 and B7.2.7. The following discussion is relevant to all safe rooms, regardless of their intended use.

A4.4.1 FOOD AND WATER

For tornado safe rooms, because of the short duration of occupancy, stored food is usually not a primary concern, but the provision of water should be addressed in the O&M plan.

For hurricane safe rooms, because they can be occupied for 24 hours or more during a hurricane, food and water will be needed. Some O&M plans charge occupants with the responsibility of bringing enough food to last for the anticipated duration of the hurricane. Regardless, provision of food and water should be addressed in the O&M plan.

More Information

FEMA guidance on food and water storage is available at <https://www.ready.gov/food> and <https://www.ready.gov/water>.

A4.4.2 COMMUNICATIONS EQUIPMENT

FEMA recommends having a means of communication other than a landline telephone or cellular telephone in all safe rooms. Both tornadoes and hurricanes are likely to cause a disruption in one or both types of telephone service. At least one means of backup communication should be stored in or brought to the safe room, such as a handheld amateur radio, citizens' band radio, or emergency

radios capable of reaching police, fire, or other emergency services. If cellular telephones are relied upon for communications, the owners/operators of the safe room should install a signal amplifier to send and receive cellular signals from within the safe room. Occupants should remember that cellular systems may be completely saturated in the hours immediately after an incident because of the amount of cell phone traffic, or cellular service could be unavailable because of damaged cell phone towers.

FEMA also recommends that every safe room contain either a battery-powered radio transmitter or a signal-emitting device that can signal the location of the safe room to local emergency personnel if occupants in the safe room become trapped by debris blocking the exit. The safe room owner/operator is also encouraged to register the safe room with police, fire, and rescue organizations after installation or construction (refer to the “Registering the Saferoom” textbox in Section A4.2.2). Providing geographic coordinates to the safe room entrance can facilitate post-event search and rescue operations in the event the exit is blocked by debris.

A4.4.3 EMERGENCY SUPPLIES

Community safe rooms should contain emergency supplies for the safety and well-being of the occupants. At a minimum, community safe rooms should contain the following safety equipment:

- Flashlights with continuously charging batteries or a battery supply as needed
- Large (12- to 15-inch) chemical light sticks as an alternate or supplement to flashlights
- Fire extinguishers (number based on occupancy type) appropriate for use in a closed environment with human occupancy (required per ICC 500 Section 604)
- First aid kits for the safe room capacity (required per ICC 500 Section 702.9 and 703.11)
- NOAA weather radio (a signal amplifier may be needed for steel and heavily reinforced concrete, pre-cast, or masonry shelter wall and roof assemblies) with continuously charging batteries or a battery supply as needed; any antennae with vulnerability to storm damage should be mitigated
- Radios with continuously charging batteries for receiving commercial radio broadcasts
- A sounding device that continuously charges or operates without a power source (e.g., canned air horn) to signal rescue workers if safe room egress is blocked
- Tools to open inoperable or debris-blocked doors; a crowbar and sledgehammer should be kept in the safe room in case debris falls against the door and prevents exiting the safe room after an event

A4.5 Access and Entry

Gaining access to the safe room can become a source of frustration for occupants seeking life-safety protection from an impending tornado or hurricane. The O&M plan should provide details on

procedures for parking, entering the safe room, registering incoming occupants, and locking down the safe room before the tornado or hurricane strikes. As described in Section A4.3, the community needs to be informed well before an event occurs to avoid confusion and panic.

A4.5.1 PARKING

Safe rooms open to the general public

Parking problems can adversely affect safe room access, potentially preventing occupants from entering the safe room before a tornado or hurricane strikes. Reasonable assumptions should be made about parking, and planned for accordingly, for safe room occupants based on the safe room's intended operations. If the planning assumptions are not reasonable, there might not be enough parking spaces during an actual event. Likewise, an insufficient road network in the vicinity of the safe room could result in heavy traffic caused by a sudden influx of vehicles, which could prevent people from quickly accessing the safe room. For instance, parking capacity at community safe rooms can be a problem if neighborhood residents, who are expected to walk, drive to the safe room instead. Parking and the existing road network should be tested during a drill, per Section A4.3.5, to see if the planning assumptions are reasonable and the O&M plan is effective. If not, the planning assumptions and O&M plan should be modified accordingly.

A4.5.2 ENTERING THE SAFE ROOM

Safe rooms open to the general public

Confusion has occurred during past tornado incidents when residents evacuated their homes to go to a community shelter, but could not get in. For example, during the Midwest tornadoes of May 3, 1999, residents in a Wichita neighborhood went to their assigned tornado shelter only to find it locked. The shelter was eventually opened prior to the event, but had there been less warning time for the residents, people could have been injured or killed.

The O&M plan should clearly state who is to open the safe room and identify backup personnel to respond during every possible emergency. Some community safe rooms have been installed with locks that can be operated remotely. When triggered by community alert signals (the activation trigger should be clearly stated in the O&M plan), remote unlocking systems can improve safe room access efficiency. These can be set to open automatically whenever there is a watch issued for the area, sirens are activated, or at the discretion of the owner or operator of the safe room. They can also be set to turn on lights so that the occupants do not have to search for light switches. Remote unlocking can be beneficial during evening and nighttime hours when people are not likely to already be present and able to open the facility immediately. However, appropriate cybersecurity measures should be considered to prevent unauthorized opening of the safe room. If the remote unlocking is not automatically triggered and requires human intervention, providing access to unlock the safe room to a 24-hour facility, such as a sheriff's office, is wise. A plan for manual redundancy should be in place when using remote unlocking, in case it fails.

Safe rooms for specific occupants

When a safe room is open to only a select group of occupants, the safe room owner and operator should make sure the policy on who can enter the safe room is clearly communicated (refer also to Section A4.3). Contingencies should be in place for visitors that may be present on site during an event. As with safe rooms open to the general public, redundancy for opening the safe room should be provided by identifying backup personnel to arrive and unlock the safe room for entry. Some small community safe rooms and other safe rooms for specific occupants have given keys or access codes to all identified potential occupants.

A4.5.3 REGISTERING OCCUPANTS

Registering and tracking all incoming occupants of a safe room is an important process. This will enable safe room operators to identify which occupants may need medical attention or have other specialized needs (refer also to Section A4.3.4). Suggested information to collect includes the number of occupants, genders, ages, relative location they came from, and approximate travel time. The data collected can be used for post-incident analysis of capacity numbers, estimated travel distances, assumptions that may require modification, parking adequacy, and other related issues that may need to be updated in the O&M plan to improve future safe room use.

In cases of extreme urgency, the registration process should not impede the occupants' admission into the safe room and may be conducted after the safe room has been secured. The registration process should not slow the movement of occupants into the safe room but may be conducted near the entrance of the safe room, with signs posted to clearly direct people to the registration area. The list of occupants can be used to account for all occupants after the event.

A4.5.4 LOCKING DOWN THE SAFE ROOM

Locking down a safe room refers to the final preparations that are vital to provide near-absolute occupant protection from the hurricane or tornado. Locking down the safe room includes closing and latching and locking all operable impact protective systems, such as shutter (see Figure A4-5) and door assemblies.



Figure A4-5: Interior operated safe room shutters in a multi-purpose classroom/safe room. Image on left is normal usage; image on right shows shutters in "lock down" position where they are closed and latched

All safe rooms

The process of locking down the safe room needs to be completed before tornado or hurricane conditions pose a threat to the occupants. A final check should be made before locking down the safe room to ensure no more citizens are approaching, but a judgment call may be necessary when a tornado strike is imminent. Warning times for hurricanes are typically much longer, so people have more time to prepare and get to a safe room than is the case with tornado warnings. As a result, locking down a hurricane safe room is generally less urgent. Specific personnel should be assigned the responsibility of locking down a safe room (with a backup), and conditions for when the safe room is to be locked down should be clearly defined.

Safe rooms for specific occupants

O&M plans for school safe rooms should include a step to ensure all students are accounted for prior to lockdown.

A4.6 Operations during an Event

Safe room operations during an event include maintaining security and safety, providing first aid, and establishing and maintaining communication with appropriate authorities outside the safe room. While not exhaustive, the operations described in the following section should be addressed in the safe room O&M plan.

A4.6.1 SECURITY

Safe rooms open to the general public

Safe room security and safety must be maintained by controlling the movement of people and preventing unauthorized entry into hazardous or secured areas, or unauthorized exit before the event has passed. Some O&M plans may assign security responsibilities to members of the community police force to facilitate crowd control and enhance enforcement of safe room rules. Security operations and related responsibilities should increase with the safe room's anticipated population.

Safe rooms for specific occupants

If the safe room is at a residential care facility such as a nursing home or hospital, additional areas within the facility may need to be protected. Such areas may include medical and pharmaceutical storage areas and intensive/critical care areas that house non-ambulatory patients. Safe rooms should meet the needs of all the occupants.

Hurricane Ian MAT Report Recommendation: Space for Security Personnel

- **Recommendation FL-44a:** In emergency and shelter planning and designs, shelter planners, operators, and design professionals should consider identifying or designing a location or creating a cordoned off area within the shelter to house security personnel. For shelters with security personnel, whether law enforcement officers, national guard, or private security,

planners, operators, and designers should consider having an area separated from the general population to house the security team. The designing, sizing, and developing of the floor plan of the safe room should consider this additional space. In interviews conducted by the MAT and shelters observed by the MAT, security incidents were reduced when security personnel were on the premises during the duration of shelter operations.

- **Recommendation FL-44b:** FEMA should consider revising guidance on safe rooms with security personnel. As a best practice, safe rooms should include a room or cordoned off area to house security personnel. As such, the safe room usable area should be increased accordingly.

A4.6.2 FIRST AID AND HEALTH SERVICES

All safe rooms

Safe room staff with the necessary training and certification should be designated in the O&M plan to administer first aid as needed (see A4.3.4). Operators of tornado safe rooms should be prepared for occupants to arrive injured as people are often injured in their haste to access the safe room. Operators of hurricane safe rooms may need to appoint personnel to administer first aid and address other health issues that may arise during the extended stay.

Information collected on the access and functional needs of potential occupants (refer to Section A4.3.4) should be made available to personnel registering arriving occupants to identify those with possible acute health service needs.

NOTE

Pandemic Considerations

For community safe rooms, FEMA recommends owners and operators follow guidelines and policies established by local authorities. Potential safe room occupants should check with local authorities to make sure the designated safe room will be open and available. If local officials open a community or group shelter, and that is the safest location for an intended occupant, they should follow the requirements of the state and local health regulatory authorities as well as the latest guidelines from the Centers for Disease Control and Prevention (CDC) for protection against a communicable disease.

A4.6.3 COMMUNICATION

All safe rooms

Communication between the safe room, local EOCs, and other components of the disaster relief operation are critical during an extreme-wind incident. Depending on the incident, the staff responsible for establishing initial (pre-event) contact and a working relationship with the local EOC may also need to monitor weather conditions remotely to provide occupants with updated

information. Section A4.4.2 includes a discussion of alternate means of communication that may be needed when telephone service is disrupted or anticipated to be disrupted.

Upon receiving confirmation that the danger has passed, a designated decision-maker will need to alert occupants that it is safe to exit the safe room.

A4.6.4 FIRE SAFETY

All safe rooms

Given the conflicting objectives between building occupant protection for a fire hazard (evacuate) and an extreme wind hazard (shelter-in-place), FEMA strongly recommends safe room owners and operators give special consideration to fire safety within the safe room. One approach is to elevate fire safety vigilance through designation of “Fire Watch” personnel as described in ICC 500 Appendix A. Duties of the appointed personnel should include conducting periodic inspections of the safe room to identify and mitigate fire hazards and watching for smoke, fire, and obstructed egress during occupation of the safe room. Appointed personnel should also examine the exterior perimeter of the safe room to identify fire hazards outside of the safe room as well. Further, the safe room staff should discuss how and when to egress occupants from the safe room in the event that fire hazard is determined to be greater than the concurrent extreme wind hazard. ***BEST PRACTICE: As described in Chapter B6, direct egress to the exterior of the building is considered best practice for internal safe rooms with respect to fire safety, ventilation, and potential collapse of the host building.***

A4.7 Post-Event Operations

Immediately after an event, all occupants should be accounted for, especially those that have medical needs to ensure they receive the appropriate care. Any equipment brought to the safe room for either medical or other reasons should be returned. Equipment used during the event, such as generators and backup utility sources, should be turned off as they are no longer needed. Whenever possible, safe room operators should coordinate with emergency responders following a tornado or hurricane before egressing occupants from the safe room. Information shared about the presence of storm debris or damaged utilities (e.g., downed power lines, gas leaks) will serve to protect occupants in the post-storm environment.

Safe room operators need to coordinate closing down the safe room and preparing it for a future incident. The safe room should be cleaned after an incident and all the supplies should be inventoried and replaced as needed, including food and water.

Safe room owners and operators should review the O&M plan after an incident and incorporate any lessons learned so that improvements to the plan are tracked and implemented. If no incidents occur, safe room owners and operators should review the O&M plan at least annually and provide updates as needed. The O&M plan should be reviewed, and preventable problems that occurred should be fixed for future incidents. In some cases, developing an after-action report outlining the successes and failures of safe room operation components may be helpful in improving the O&M plan through revision.

A4.8 Maintenance

An effective maintenance plan will help ensure that the safe room equipment and supplies are fully functional during and after incidents. Each community safe room should include maintenance information in its O&M plan, including the following:

- **Update schedule.** A schedule for updating the O&M plan. Regardless of whether an incident occurred, the safe room O&M plan should be reviewed and updated at least annually to ensure the most current information is included in the plan.
- **Inventory checklist.** An inventory checklist of the emergency provisions described in Section A4.4, which includes essential equipment and supplies, such as communications equipment, emergency equipment, first-aid supplies, water, and sanitary supplies. Example inventory checklists are available on the FEMA safe room website at <https://www.fema.gov/emergency-managers/risk-management/building-science/safe-rooms/resources>.
- **Redundant power.** Information about the designated redundant power source(s) (e.g., batteries and/or generators) needed to satisfy the safe room standby power requirements for lighting and ventilation (refer to Section B7.2.6).
- **Maintenance schedule.** A schedule showing regular safe room maintenance to be performed by a designated party. Regular maintenance and periodic testing should be performed for the following:
 - **Designated standby power source.** All batteries and fuel for emergency generators, flashlights, and emergency exit signs should be replaced, cycled out, or recharged according to a schedule.
 - **Door assembly.** Maintaining the door assembly is especially important because specialized safe room door hardware can easily fall out of adjustment, rust, or stick due to lack of lubrication resulting in and failure to quickly engage during an event. If door hardware needs to be replaced, making sure the replacement meets the performance criteria is important. For more information on community safe room door maintenance, refer to FEMA's fact sheet *Community Tornado Safe Room Doors Installation and Maintenance* (2024a).
 - **Ventilation, sanitation, and lighting systems.**
 - **Safe room envelope and components.** Maintenance should address water intrusion into the safe room. The water tightness of the safe room roof, flashings, walls, and caulk joints in masonry control joints, pre-cast or tilt-up concrete joints, joints around door and window frames, etc. should be regularly maintained to prevent degradation of the safe room envelope and components. Refer to Section B1.2.10 for additional details on evaluation, maintenance, and repairs.

- **Perishable schedule.** A schedule for checking perishable safe room items such as bottled water and food, as well as first aid supplies, for their “use by” dates or cycling them out.
- **Inventory schedule.** A schedule for inventorying and testing emergency equipment and tools to ensure they are in working condition (including flashlights and communication devices).
- **Multi-use safe room occupant space availability.** A schedule for checking that normal daily usage of the safe room space will not interfere with timely safe room operations (i.e., the approved safe room design occupant capacity will be available at all times).
- **Verification of proper signage.** Basic exterior and interior signage will be maintained as required for effective safe room operations.

This page left blank intentionally

Part B

This page left blank intentionally

Chapter B1 Application and Administration

This chapter uses Chapter 1 of ICC 500 as the referenced standard and includes a list of FEMA Funding Criteria that FEMA has identified as more conservative than the provisions in Chapter 1 of ICC 500. This chapter also includes additional guidance on the application and administration of safe rooms based on many years of field observations and investigations related to safe room performance.

FEMA Safe Room Grant Requirements

Whenever a safe room is constructed with FEMA grant funds, the FEMA Funding Criteria in Section B1.1 become requirements in addition to the requirements of ICC 500 Chapter 1.

B1.1 Criteria

The application and administration of safe rooms should be conducted in accordance with the provisions of Chapter 1 in ICC 500 as amended by FEMA Funding Criteria as shown in Table B1-1.

Table B1-1: Comparison of ICC 500 Requirements to FEMA Funding Criteria

ICC 500 Reference	ICC 500 Requirements ^(a)	FEMA Funding Criteria ^(b)
Section 106.2 Design Information	<p>For the areas of a building designed for occupancy as a storm shelter, the following information shall be provided within the construction documents:</p> <p>A statement that the design conforms to the provisions of the ICC 500 <i>Standard for the Design and Construction of Storm Shelters</i>, with the edition year specified.</p>	<p>A statement that the design conforms to the provisions of the ICC 500 <i>Standard for the Design and Construction of Storm Shelters</i>, with the edition year specified and to the FEMA Funding Criteria of FEMA P-361, with the edition year specified.^(c)</p>

Bolded text denotes differences between the ICC 500 Requirement and the FEMA Funding Criteria.

Notes:

- (a) ICC 500 language reprinted here with permission from the International Code Council.
- (b) Table only lists requirements where there are differences between FEMA P-361 and ICC 500 Chapter 1. All ICC 500 Chapter 1 requirements not listed in the table should also be met in their entirety. Safe room types (e.g., community, residential, tornado, hurricane) outside the scope of any given FEMA Funding Criterion need only meet the corresponding ICC 500 criteria (where applicable).
- (c) Noted FEMA Funding Criteria apply to all safe rooms except residential prefabricated safe rooms listed and labeled to comply with ICC 500-2023 for the design tornado speed of 250 mph in accordance with ICC 500 Figure 304.2.

B1.2 FEMA Additional Guidance

FEMA offers the following background information and guidance for the criteria referenced in ICC 500 Chapter 1 or presented as FEMA Funding Criteria in Section B1.1.

B1.2.1 OCCUPANCY GROUP CLASSIFICATIONS FOR SINGLE-USE AND MULTI-USE SAFE ROOMS (REFERENCE: ICC 500 SEC 104)

Occupancy Group classifications are provided in IBC Chapter 3 and are used throughout the building code to inform an array of construction provisions that include building limitations, means of egress, fire protection systems, and interior finishes. Where the design occupant load is 50 or more, single-use community safe rooms (facilities designed solely to function as safe rooms) are required by ICC 500 to be classified as Group A-3 occupancies (A=Assembly). Community safe rooms with a design occupant load of fewer than 50 can be classified as Group B (B=Business) occupancies in accordance with ICC 500, which references the IBC Section 303 provision for “small buildings and tenant spaces.” Similarly, residential safe rooms are required to be classified as Group R (R=Residential) or to comply with the IRC where applicable.

Conversely, the occupancy classification for multi-use safe rooms is determined based solely on the normal use (i.e., non-safe room use) of the shared space. Allowing normal use occupancy group classification for multi-use safe rooms has provided for more practical and economical construction of tornado safe rooms on school campuses and elsewhere, because tornado safe room design occupant capacities often significantly exceed normal use occupant loads. For example, a tornado safe room that also serves as a classroom would require more egress (doors) to safely evacuate the larger safe room population in the case of fire (see example in Section B5.2.1.1). From a practical perspective, the normal occupancy allowance for multi-use safe rooms may be regarded as protecting safe room occupants by effectively limiting the number and sizes of doors to satisfy the smaller capacity because even when protected by compliant safe room door assemblies, large openings in the safe room envelope are more vulnerable to breaching than solid wall and roof assemblies. Economically, safe room-compliant doors are much more expensive than non-compliant doors, so fewer doors make the safe room more affordable. The implications of the normal use occupancy group classification for multi-use safe rooms are broad, but perhaps most critical for fire-safety and egress considerations, which are further addressed in Chapters B5 and B6. For more information on the advantages and disadvantages of single-use versus multi-use safe rooms, please refer to Section A3.1.1.

B1.2.2 APPLICABLE CODE (REFERENCE: ICC 500 SEC 101 AND 105)

ICC 500 Section 101.3 specifies that “where requirements are not provided by this standard, the applicable provisions of the applicable codes adopted by the authority having jurisdiction shall apply to the storm shelter.” For resolving questions on safe room design criteria, this publication includes guidance (see Section B3.2.1) indicating that where design criteria are not addressed in FEMA P-361 or ICC 500, the user should determine the appropriate criteria from the applicable code.

Safe rooms constructed in jurisdictions where no applicable codes are adopted should be designed and constructed according to FEMA P-361 and the provisions of the edition of the IBC (or IRC where applicable) that is referenced in the latest edition of the ICC 500. Demonstrating the compliance of a safe room with the design and construction requirements in ICC 500 and the applicable code becomes more demanding in areas with little or no jurisdictional oversight. The textbox on page B1-4

provides guidance on designer responsibilities when safe rooms are constructed in areas with little or no jurisdictional oversight.

CODES AND STANDARDS

ICC 500-2023 and the 2024 editions of the IBC and IRC are available from the following links:

- <https://codes.iccsafe.org/content/ICC5002023P1>
- <https://codes.iccsafe.org/content/IRC2024P1>
- <https://codes.iccsafe.org/content/IBC2024P1>

Permitting and Code Compliance

Before construction begins, all necessary state and local building and other permits should be obtained. In addition to the submittal documents required in ICC 500 Section 106, the Quality Assurance Plan (QAP), peer review report, and owner's statement of responsibility must also be submitted to the authority having jurisdiction when applying for permits. The registered design professional (RDP) should meet with the local code official to discuss any concerns the building official may have about the safe room design. This meeting would help ensure that the safe room is properly designed and constructed to local ordinances or codes in addition to the provisions of FEMA P-361.

NOTE

FEMA P-361

FEMA P-361 (2024) supersedes the *FEMA National Performance Criteria for Tornado Shelters* (1999), as well as any previous editions of FEMA P-361.

The requirements for the design and construction of storm shelters and safe rooms to meet or exceed the criteria in ICC 500 or FEMA P-361 are established by the authority having jurisdiction. The authority having jurisdiction establishes the requirements by either adopting the 2009 or later editions of the IBC and IRC that incorporate the ICC 500 standard by reference or by explicitly adopting FEMA P-361 or ICC 500 as a design standard for safe rooms or storm shelters.

EXAMPLE**FEMA Safe Room Helpline Guidance When There Is No Authority Having Jurisdiction**

Inquiry: I'm an RDP whose client has asked for a tornado safe room within a new building that our company is designing. Is any permitting or documentation required beyond our construction documents when there is no authority having jurisdiction for the location of the new building?

Response: The responsibility of the RDP is not waived or lessened regardless of the safe room size and/or capacity. The design professional of record and building owner should exercise even more caution when there is no authority having jurisdiction because there is no building department to establish documentation. Photographs taken during construction can be used to support documentation efforts. One option is to develop agreements that require contractors to take specific photographs at specific stages of construction and include them in their daily reports.

For areas lacking a building department or an engaged authority having jurisdiction, the recommended approach is as follows:

1. Check to see if permitting is provided by the building department. If so, are reviews/inspections also provided? As described above without an authority having jurisdiction, the RDP should take responsibility for all documentation.
2. Special inspections as required by ICC 500 and the building code need to be carried out in the same manner as when an authority having jurisdiction is in place because special inspections and structural observations are independent of the authority having jurisdiction.

Inquiry: When there is no authority having jurisdiction, what process do we need to follow to document compliance beyond the engineering that is provided on our construction documents?

Response: Special inspectors or RDP representatives (members of the design team) should provide inspections that would normally be the responsibility of the authority having jurisdiction or you can hire another firm to provide construction administration services. Small, local design firms may be able to do this type of work where time/distance constraints limit the availability of the safe room design team. Also, you may wish to hire someone (e.g., owner, owner's agent) to take site photographs frequently and notify you immediately of potential issues observed.

Storm Shelter Requirements in the Building Codes

Storm shelter requirements have been included in the IBC (Section 423) and IRC (Section 323) since the first edition of ICC 500 (2008) became available for reference. The IEBC began referencing ICC 500 in the 2018 edition.

Since 2015, Section 423 of the IBC has required ICC 500 storm shelters for the following buildings when they are constructed in areas where the storm shelter design tornado speed is 250 mph (see Figure B3-1 for wind speed zone details):

- K-12 school buildings with an occupant load of 50 or more

- 911 call stations
- Fire, rescue, ambulance, and police stations
- EOCs

Although not required by the building code, FEMA recommends that owners of all types of buildings both inside and outside the 250 mph tornado storm shelter design wind speed zone consider safe room construction with respect to the threat of extreme wind hazard and the building and population vulnerabilities as described in Chapter A2.

In the 2018 IBC, the provisions for required tornado storm shelters in Group E occupancies were expanded to limit the distance between the storm shelter entrance and at least one exit of the buildings served by the storm shelter to a maximum of 1,000 feet (reference Section B4.2.2.6 for FEMA travel time requirements and recommendations). Additionally, where required for Group E occupancies, storm shelter minimum capacity requirements were clarified in the 2018 IBC to include criteria that differed from FEMA HMA funding requirements. Similar requirements for siting limitations and minimum capacity requirements were added for critical emergency operation facilities in the 2024 IBC. FEMA recommends that Group E and critical emergency operation facility safe room applicants in tornado-prone regions work with state and Regional FEMA grant personnel, authorities having jurisdiction, and others as appropriate to ensure compliance with both HMA policy and locally adopted codes.

Beginning with the 2018 edition, the IEBC has required storm shelters for additions to Group E buildings. The provisions are intended to supplement IBC storm shelter requirements for new Group E buildings and are similar in scope. However, the 2021 IEBC removed the maximum 1,000 feet travel distance requirement (described above for IBC) in recognition that layouts of existing campuses—particularly large campuses—overly restricted compliance options for siting the required storm shelters.

The 2021 and 2024 IRC include language requiring permits for all storm shelters. The change addresses concerns that some were being exempted from permit as “accessory structures.” To be able to provide life-safety protection from extreme wind events, storm shelters’ designs are much more complex than typical accessory structures. As such, storm shelter construction and installation should always require a building permit to provide quality assurance for all potential storm shelter occupants.

B1.2.3 SUBMITTAL DOCUMENTS (REFERENCE: ICC 500 SEC 106)

In accordance with ICC 500, FEMA requires that construction documents for safe room grant projects be prepared, sealed by an RDP, and submitted to the authority having jurisdiction. Such documents should contain the design information as required by Section 106.2 of ICC 500 with the additional statement indicating compliance with FEMA P-361, as shown in Table B1-1 of this chapter. Not every item of the design information listed in Section 106.2 applies to every safe room. For example, the last three items apply to hurricane shelters only, and item 11, which includes flood

criteria that are used to determine minimum floor elevations, only applies to safe rooms located in the flood-prone areas designated in ICC 500 Section 401.2 as amended by Table B4-1. However, the authority having jurisdiction where the safe room is to be installed, the applicant responsible for managing the grant, or the FEMA grant personnel responsible for oversight of the grant may require additional construction documents.

TERMINOLOGY

Construction Documents: IBC defines construction documents as written, graphic, and pictorial documents prepared or assembled for describing the design, location, and physical characteristics of the elements of a project necessary for obtaining a building permit.

To facilitate review by the code official (and the peer reviewers where required) as well as future reference needs (e.g., during and after construction), all design information required in Section 106.2 should be included on or explicitly referenced in a single cover sheet attached to the submittal documents package. Community safe rooms submittal documents are also required to include manufacturer's details, installation instructions, and instructions needed for functional operation of the safe room.

BEST PRACTICE: All submittal documents should be maintained for the life of the safe room to simplify future maintenance or potential adaptations of the safe room and surrounding host building spaces. The best practice applies to safe room owners and to applicable grant and permitting agencies. Refer to the "Record Retention" textbox in this section for information on record maintenance minimums for all federal agencies.

NOTE

Records Retention

Per federal grants regulations at Title 2 of the Code of Federal Regulations (CFR) Section 200.334, records for real property and equipment must be maintained for 3 years after final disposition. According to the 2024 *HMA Program and Policy Guide*, "the subrecipient should retain construction documents that are in support of FEMA-assisted work for the lifespan of the safe room."

B1.2.4 QUALITY ASSURANCE PLAN (REFERENCE: ICC 500 SEC 107)

Because storm shelters and safe rooms are expected to provide life-safety protection from extreme wind events, quality assurance requirements for their construction should be more stringent than those applied to normal building construction. Accordingly, ICC 500 requires QAPs for all community storm shelters; since Section B1.1 of this publication does not include FEMA Funding Criteria relating to Section 107 of ICC 500, the standard criteria govern both storm shelters and safe rooms. The

safe room design team should use the QAP to coordinate post-permitting activities, including structural observations and all inspections. Minimum inspection criteria for storm shelters are addressed in Section 111 (Special Inspection) of ICC 500; structural observations are addressed in Section 112.

The safe room QAP should identify all applicable main wind force resisting systems (MWFRSs) and wind-resistant components listed in Section 107.1. Like the required construction document design information described in Section B1.2.3, not every QAP item will apply to every safe room, and the authority having jurisdiction, the applicant responsible for managing the grant, or the FEMA grant personnel providing oversight of the grant can request additional items as needed. To facilitate review of the QAP and execution of the tests, inspections, and structural observations detailed within it, FEMA recommends including a table of contents outlining the organization of individual QAPs and an overall schedule or flowchart to address the anticipated sequence of QAP activities.

B1.2.5 PEER REVIEW (REFERENCE: ICC 500 SEC 108)

Construction documents for community safe rooms designed for more than 50 occupants, as well as for safe rooms in an elementary school, secondary school, day care facility with an occupant load greater than 16, or any Risk Category IV building, are required to undergo peer review. The requirement for peer review applies to both site-built and prefabricated storm shelters that meet the above criteria.

The peer review is required to verify compliance with Chapters 3, 4, 5, 6, and 7 of ICC 500. The peer review is also required to verify compliance with Section 106 (Submittal Documents), Section 107 (Quality Assurance Plan), Section 111 (Special Inspections), and Section 112 (Structural Observations) of the standard.

CODES AND STANDARDS

2024 IBC Table 1604.5 describes Risk Category IV buildings and structures as designated essential facilities. They are required to be designed and constructed using enhanced structural criteria, so they are more likely to be operational after incurring higher loads resulting from rarer (and more extreme) flood, snow, wind, or earthquake hazard events.

IBC-consistent Risk Category classifications for buildings and other structures can be found in Table 1.5-1 of ASCE 7.

Like the safe room design team that develops the construction documents, peer review typically involves multiple design professionals to adequately address all relevant architectural and engineering subdisciplines scoped in the report. To discourage potential peer reviewer bias, the standard requires that the peer reviewer in charge be hired by the safe room owner or owner's representative as opposed to the RDP in responsible charge of the project, unless the RDP in responsible charge is also the owner. In turn, the hired peer reviewer must disclose to the authority

having jurisdiction any conflicts of interest—financial or otherwise—that could compromise the independence of their review. They must also submit written documentation of each reviewer’s qualifications. Following the comprehensive peer review, a signed and sealed report should be submitted to the authority having jurisdiction by the safe room owner or owner’s representative when applying for the building permit. This report should include detailed descriptions of the items reviewed and a recommendation of acceptance or rejection for each with an explanation provided for rejected items.

Any proposed structural changes¹ that occur after submittal of the peer review report but before building permits are issued should be submitted to the peer reviewer for review by the RDP in responsible charge. After the project has been permitted, safe room construction oversight responsibilities shift to the RDP in responsible charge in coordination with the authority having jurisdiction who can choose to reengage the peer reviewer as needed. However, as described in Section B1.2.4, the QAP, which is required for all community storm shelters and safe rooms, should provide an additional layer of checks and balances throughout construction.

B1.2.6 OWNER’S RESPONSIBILITY (REFERENCE: ICC 500 SEC 109)

Since ICC 500-2020, owners of new community storm shelters and safe rooms have been required to 1) submit a statement of responsibility for ongoing O&M of the facility with the application for permit, and 2) submit a storm shelter (or safe room) preparedness and emergency operations plan that is needed for approval of the certificate of occupancy. ICC 500-2023 adds a third requirement under “Owners Responsibility” for a critical support system evaluation and maintenance plan to be submitted to the authority having jurisdiction; requirements for the plan are addressed in Section 113 (see Section B1.2.9). ICC 500-2023 includes Appendix A, “Storm Shelter Preparedness and Emergency Operation Plan (SSPEOP),” with minimum requirements for the SSPEOP in jurisdictions that choose to adopt it. Jurisdictions that choose not to adopt Appendix A may regard the requirements as non-mandatory guidance (or a template) for what should be covered in the mandatory SSPEOPs. The ICC 500 Appendix A requirements may be more detailed than O&M plan requirements in the *HMA Program and Policy Guide*, so FEMA recommends that where ICC 500 Appendix A has been adopted, safe room applicants work with state and Regional FEMA grant personnel to ensure compliance with both HMA policy and locally adopted codes.

B1.2.7 CONTRACTOR’S STATEMENT OF RESPONSIBILITY (REFERENCE: ICC 500 SEC 110)

Prior to the start of work on every safe room system and component outlined in the QAP, the contractor responsible for construction, fabrication, or installation is required to submit a statement of responsibility to the authority having jurisdiction. In accordance with ICC 500 Section 110, each contractor’s statement of responsibility should include the following:

¹ Specifically, structural changes refer to changes to the MWFRS or Components and Cladding (C&C).

- Acknowledgement of awareness of the special criteria contained in the QAP
- Acknowledgement that control will be exercised to obtain conformance with the contract documents
- Procedures for exercising control within the contractor's organization, and the method and frequency of reporting and distributing reports
- Identification and qualifications of the person exercising such control and their position in the organization

Although contractors should not be held responsible for the fabrication of components manufactured and certified by others to meet safe room criteria, they should be held responsible for purchasing and installing components that are consistent with the contract documents and instructions provided by the manufacturer so that they provide the appropriate level of protection.

B1.2.8 SPECIAL INSPECTIONS (REFERENCE: ICC 500 SEC 111)

Aside from the special inspection for anchor installation described below, special inspection requirements in ICC 500 consist of inspections for “special cases” and “fabricators,” which reflect the parallel requirements in the referenced edition of the IBC. But the special inspections required for storm shelters and safe rooms are intended to supplement, not replace, those required by the applicable code. Where safe rooms are constructed concurrently with the host building, a combined, single statement of special inspections is allowed to be submitted with specific references to required inspections for the safe room MWFRS and wind-resisting components provided in the QAP.

Special Inspection to Verify Anchor Installation

As more safe rooms and ICC 500-compliant storm shelters are installed, many units (including prefabricated safe rooms or storm shelters) are being installed directly onto existing slab-on-ground foundations through post-installed anchor applications. These existing foundations are typically not adequate to resist the extreme loads that a safe room or storm shelter must be designed for. Therefore, in addition to the slab being checked for compliance with the American Concrete Institute (ACI) standards ACI 318, *Building Code Requirements for Structural Concrete*, or ACI 332, *Residential Structural Concrete Code*, as specified in Section 307.2 of ICC 500, engineering calculations need to be provided to verify the adequacy of the existing slab (refer to Section B3.2.5.3.2). Post-installed anchors depend on adhesive bonding or friction for pull-out resistance. In both cases, they must be installed properly to perform as specified. Post-installed anchors must be appropriately selected by the designer and installed in accordance with the manufacturer's installation instructions as required in Chapter 17 of ACI 318. ***BEST PRACTICE: Any installer of post-installed epoxy anchors should be certified as an ACI-CRSI Adhesive Anchor Installer.***²

ICC 500 requires a special inspection be performed when anchors are post-installed into hardened concrete or masonry for storm shelter (or component) anchorage. The special inspection is intended

² ACI and CRSI (Concrete Reinforcing Steel Institute) operate a program to train and certify Adhesive Anchor Installers (www.concrete.org/certification/certificationprograms.aspx).

to verify the anchor installation and capacity as well as the foundation adequacy as detailed above. The special inspection requirements in Section 110.1.2.1 of ICC 500 can be bypassed on residential safe rooms only if the authority having jurisdiction verifies that the foundation and anchoring comply with the installation requirements for the safe room or storm shelter.

FEMA strongly recommends that building officials or other authority having jurisdiction parties ensure that the installation of the safe room complies with the design plans or the manufacturer's installation instructions (in the case of prefabricated safe rooms) before granting a waiver for the special inspection. This can be done by having the installer provide the authority having jurisdiction with the necessary information ahead of the construction process, including the engineering calculations verifying the adequacy of the slab and any existing conditions, such as the thickness of the slab and the presence of any required steel reinforcement.

B1.2.9 STRUCTURAL OBSERVATIONS (REFERENCE: ICC 500 SEC 112)

For community safe rooms, the building owner should employ an RDP licensed in the state in which the safe room will be constructed or installed to perform structural observations in accordance with ICC 500 Section 112. The scope of the structural observations is to visually observe the construction of the structural system for general conformance to the approved construction documents at significant construction stages and when the structural system is completed. Structural observation does not eliminate the need for other inspections or testing as specified by this publication, ICC 500, or the applicable code (e.g., IBC Chapter 17, "Special Inspections and Tests"). The schedule and any necessary details for the structural observations should be included in the QAP.

Deficiencies uncovered during the observations should be reported in writing to the owner and the authority having jurisdiction. At the conclusion of the work, the RDP who made the structural observations should submit a written statement to the authority having jurisdiction stating that the site visits have been made and describing any identified deficiencies that, to the best of the structural observer's knowledge, have not been resolved. Unlike peer review, the RDP performing the structural observations does not need to be independent of the design team. In fact, the effectiveness and efficiency of the observations can be enhanced when led by the project's structural engineer (or someone working under their direct supervision) because they intuitively understand the intentions conveyed through their plan specifications and structural details.

B1.2.10 EVALUATION, MAINTENANCE, AND REPAIRS (REFERENCE: ICC 500 SEC 113)

ICC 500 requirements for evaluation, maintenance, and repairs of community storm shelters' envelope components (roof/wall assemblies and Impact Protective Systems [IPS]) were added to the 2020 edition. ICC 500-2023 expands storm shelter evaluation, maintenance, and repair criteria to cover critical support systems as well. In tandem with administrative provisions for O&M statements of responsibility, SSEOPs, and critical support system maintenance and evaluation plans (see Section B1.2.5), the criteria for evaluation, maintenance, and repairs outlined in Section 113 serve to control ongoing post-construction issues that must be addressed in order for storm shelters and safe rooms to continue to provide life-safety protection for occupants. Where FEMA provides detailed

guidance on installation and maintenance of community safe room doors (see textbox), the standard establishes rules for the frequency of evaluations, how to address repairs and replacement of assemblies, and recordkeeping. The guidance and requirements are complementary developments based on observations of aging impact-protective systems that have not been sufficiently maintained and have subsequently been determined ineffective.

NOTE

FEMA Resource

FEMA's *Community Tornado Safe Room Doors: Installation and Maintenance* Fact Sheet (2024a) provides information about the selection, installation, and maintenance of safe room door assemblies for community safe rooms. The fact sheet covers what should be checked and how often, as well as several solutions related to the maintenance of safe room door assemblies. While the fact sheet discusses community safe room door assemblies, some of the information in the fact sheet is pertinent to owners of residential safe rooms. It is available for download at <https://www.fema.gov/emergency-managers/risk-management/building-science/safe-rooms/resources>.

This page left blank intentionally

Chapter B2 Definitions

This chapter defines certain “terms of art” and phrases that are used in this publication to mean something specific. Any term not defined here should be understood as having a commonly accepted meaning as implied by its context. Definitions are taken from FEMA publications and guidance materials as well as from Chapter 2 of ICC 500 and the IBC.

Definitions reprinted from ICC 500 are referenced accordingly; the definitions are reprinted here with permission from the ICC. For ICC 500-sourced definitions, references to storm shelters also apply to safe rooms.

500-Year Flood (ICC 500)

The flood having a 0.2% chance of being equaled or exceeded in any given year.

500-Year Flood Elevation (ICC 500)

The elevation of the 500-year flood, including wave height.

500-Year Flood Hazard Area (ICC 500)

The area subject to the 500-year flood.

A

Alcove Storm Shelter Entry System (ICC 500)

See the definition of “Entry System, Alcove or Baffled Storm Shelter.”

Applicable Code (ICC 500)

The regulation for design and construction of buildings and structures adopted by the authority having jurisdiction over the construction of the specific storm shelter.

Approved (ICC 500)

Acceptable to the authority having jurisdiction.

Approved Agency (ICC 500)

An established and recognized organization that is regularly engaged in conducting tests, furnishing inspection services, or furnishing product evaluation or certification, where such organization has been *approved*.

Areas of Concentrated Furnishings (ICC 500)

The areas of a storm shelter with furniture or fixtures which cannot be easily moved, including areas such as bathrooms, locker rooms, and rooms with fixed seating or fixed tables.

Areas of Open Plan Furnishings (ICC 500)

The areas of a storm shelter which are generally free of furniture or fixtures which cannot be easily moved and of interior partitions or other features which block movement through or otherwise subdivide the space.

Areas of Unconcentrated Furnishings (ICC 500)

The areas of a storm shelter with furniture or fixtures which can be easily moved, including areas such as classrooms and offices.

Authority Having Jurisdiction (ICC 500)

The organization, political subdivision, office, or individual charged with the responsibility for administering and enforcing the provisions of building codes and code-adopted standards such as ICC 500.

B

Baffled Storm Shelter Entry System (ICC 500)

See “Entry system, alcove, or baffled storm shelter.”

Base Flood (ICC 500)

The flood having a 1-percent chance of being equaled or exceeded in any given year.

Base Flood Elevation (ICC 500)

The elevation of the *base flood*, including wave height, relative to the National Geodetic Vertical Datum (NGVD), North American Vertical Datum (NAVD), or other datum specified on the *Flood Insurance Rate Map* (FIRM).

Best Available Refuge Area (BARA)

Building area (or areas) that has been determined by an RDP to be least vulnerable to the life-threatening effects of extreme-wind incidents relative to other building areas. These areas were not specifically designed as tornado safe rooms, and as a result, occupants may be injured or killed during a tornado. However, people in BARAs are less likely to be injured or killed than people in other areas of a building (text modified from FEMA P-431, *Tornado Protection: Selecting Refuge Areas in Buildings* [October 2009]).

C

Coastal A Zone (ICC 500)

Area within a special flood hazard area, landward of Zone V or landward of an open coast without mapped coastal high-hazard areas. In a Coastal A Zone, the principal source of flooding is astronomical tides, storm surges, seiches, or tsunamis, not riverine flooding. During the base flood conditions, the potential for breaking wave height is greater than or equal to 1¹/₂ feet (457 mm). The inland limit of the Coastal A Zone is one of the following:

- The Limit of Moderate Wave Action if delineated on a FIRM
- Designated by the authority having jurisdiction

Coastal High-Hazard Area (ICC 500)

Area within the special *flood hazard area* extending from offshore to the inland limit of a primary dune along an open coast and any other area that is subject to high-velocity wave action from storms or seismic sources and shown on a FIRM or other flood hazard map as velocity Zone V, VO, VE, or V1–30.

Consensus Standard

A standard developed by professional societies or by national and international standards-setting organizations through specific procedures and requirements that govern the consensus development process. The process is conducted to provide a consensus agreement among representatives of various interested or affected individuals, companies, organizations, and countries.

Critical Support Systems, Storm Shelters (ICC 500)

Systems and components required by Chapter 7 to ensure the health, safety, and well-being of shelter occupants. Critical support systems include water closets, lavatories, sanitation support systems, drinking water, roof drainage systems, ventilation systems, lighting systems, standby power systems, and emergency power systems.

D

Design Occupant Capacity, Storm Shelter (ICC 500)

The number of occupants for which the storm shelter is designed.

Design Tornado Pressure (ICC 500)

For tornado shelters, the tornado pressure on a specific location of the storm shelter's envelope, as determined in accordance with Section 304, which controls the design of components and cladding (C&C) of the storm shelter envelope or the main wind force resisting system (MWFRS) for the storm shelter.

Design Wind Pressure (ICC 500)

For hurricane shelters, wind pressure on a specific location of the storm shelter envelope, as determined in accordance with Section 304 of ICC 500, which controls the design of C&C of the storm shelter envelope or the MWFRS for the storm shelter.

E

Entry System, Alcove or Baffled Storm Shelter (ICC 500)

An entry system that uses walls and passageways to allow access to and egress from the protected occupant area while providing shielding from wind-borne debris.

Envelope, Storm Shelter (ICC 500)

The roofs, walls, and floors and the impact-protective systems that provide protection to occupants during a severe windstorm and meet the requirements of Chapter 3.

F

Falling Debris Hazard (ICC 500)

See “Hazards, Falling Debris”

Fire Barrier (ICC 500)

A fire-resistance-rated wall assembly of materials designed to restrict the spread of fire in which continuity is maintained.

FEMA Funding Criteria

Safe room criteria that are more stringent than ICC 500 and required by FEMA HMA for safe rooms constructed with FEMA grant funds. They are identified and described (where applicable) in the first section of each FEMA P-361 Part B chapter, and summarized in FEMA P-361 Appendix D.

Flood Elevation (ICC 500)

The base flood elevation (BFE), 500-year flood elevation or storm surge flood elevation applicable for the design and construction of a storm shelter.

Flood Elevation Study (ICC 500)

An examination, evaluation, and determination of flood hazard and, where appropriate, corresponding water surface elevations, or an examination, evaluation and determination of storm surge inundation, including coastal wave effects, associated with the maximum intensity hurricane.

Flood Hazard Area (ICC 500)

The greater of the following two areas:

1. The area in a floodplain subject to the base flood.
2. The area designated as a flood hazard area on a community’s flood hazard map, or otherwise legally designated.

Furnishings (ICC 500)

See “Areas of concentrated furnishing,” “Areas of open plan furnishings,” and “Areas of unconcentrated furnishings.”

H

Hazards (ICC 500)

- **Coastal.** See “Coastal High-Hazard Area.”
- **Falling Debris.** Exterior components, cladding, and appurtenances, such as parapet walls, masonry cladding, or rooftop equipment, that could fall onto the roof of a storm shelter from windstorm damage to adjacent, taller buildings or taller sections of a host building.
- **Flood.** See “Flood Hazard Area.”
- **Laydown.** Adjacent building elements, other structures and natural objects that could fall onto the roof of a storm shelter, such as exterior walls of adjacent single-story structures, self-supporting towers, poles, or large trees.

Horizontal Assembly (ICC 500)

A fire-resistance-rated floor or roof assembly of materials designed to restrict the spread of fire in which continuity is maintained.

Host Building (ICC 500)

A building which is not designed or constructed as a storm shelter that totally or partially encloses a storm shelter or is connected to a storm shelter.

Hurricane Shelter (ICC 500)

A storm shelter specifically for use to protect occupants during hurricanes.

I

Impact-Protective System (ICC 500)

An assembly or device, subject to static or cyclic pressure and impact testing as detailed in this standard, installed to protect an opening in a roof, wall or floor of the storm shelter envelope.

L

Label (ICC 500)

An identification applied on a product by the manufacturer that contains the name of the manufacturer, the function and performance characteristics of the product or material, and the name and identification of an approved agency and that indicates that the representative sample of the product or material has been tested and evaluated by an approved agency.

Labeled (ICC 500)

Equipment, materials, or products to which has been affixed a label, seal, symbol, or other identifying mark of a nationally recognized testing laboratory, approved agency, or other organization concerned with product evaluation that maintains periodic inspection of the production of the above-labeled items, and whose labeling indicates either that the equipment, material, or product meets identified standards or has been tested and found suitable for a specified purpose.

See also “Label.”

Laydown Hazards

See “Hazards, Laydown.”

Listed (ICC 500)

Equipment, materials, products, or services included in a list published by an approved organization acceptable to the building official and concerned with evaluation of products or services that maintains periodic inspection of production of listed equipment or materials or periodic evaluation of services and whose listing states either that the equipment, material, product, or service meets identified standards or has been tested and found suitable for a specified purpose. Terms that are used to identify listed equipment, products, or materials include “listed,” “certified,” “classified,” or other terms as determined appropriate by the listing organization.

N

Natural Ventilation (ICC 500)

Passive ventilation, not requiring a power source, resulting from convection of heated air, movement of inside air, and movement of outside air over and around the storm shelter, resulting in air exchange through vent openings.

Near-Absolute Protection

Level of protection afforded to the occupants of a safe room built according to the guidance in the most current edition of FEMA P-361. Our current knowledge of tornadoes and hurricanes indicates that safe room occupants will have a very high probability of being protected from injury or death.

O

Occupant Support Areas (ICC 500)

Areas within the storm shelter envelope required to serve the health, safety, and well-being of occupants including but not limited to, storm shelter management, food preparation, storage, electrical and mechanical rooms, toilet and other sanitation rooms, and first-aid stations.

Occupied Storm Shelter Areas (ICC 500)

The designated storm shelter area within the storm shelter envelope.

On-Site (ICC 500)

Either inside, immediately adjacent to, or on the same site as the designated storm shelter, and under the control of the owner or lawful tenant.

P

Prefabricated Safe Room

A safe room that has been assembled off-site and transported to the site where it will be installed.

Protected Occupant Area (ICC 500)

The portions of the storm shelter area that are protected from intrusion of wind-borne debris.

R

Rebound Impact (ICC 500)

The impact by a test missile, or fragments thereof, on a portion of the storm shelter envelope after the test missile has impacted another surface of the storm shelter envelope.

Registered Design Professional (IBC)

An individual who is registered or licensed to practice their respective design profession as defined by the statutory requirements of the professional registration laws of the state or jurisdiction in which the project is to be constructed.

Rolling Door Assembly (ICC 500)

A vertically operating coiling door made of a curtain consisting of formed metal slats interlocking together, supported by a barrel assembly at the top of the opening, operating by means of angles acting as door guides at the jambs.

S

Safe Room

A storm shelter specifically designed to meet FEMA Funding Criteria and provide near-absolute protection in extreme-wind events, including tornadoes and hurricanes.

See also “Near-Absolute Protection.”

- **Residential Safe Room.** A safe room serving occupants of dwelling units and having a design occupant capacity not exceeding 16 persons.
- **Community Safe Room.** Any safe room not defined as a residential safe room. This includes safe rooms intended for use by the general public, by building occupants or a combination of both.

- **Stand-alone safe room.** A separate building (i.e., not within or attached to any other building) that is designed, constructed (or retrofitted), and sited in accordance with FEMA P-361 to provide near-absolute protection from tornadoes and/or hurricanes.
- **Internal safe room.** A FEMA P-361-compliant room or area enclosed by or attached to a larger building (aka host building). An internal safe room (room or area) should be designed and constructed (or retrofitted) to be structurally independent of the host building, providing the same wind and wind-borne debris protection as a stand-alone safe room. The design of the safe room should assume the failure of the host building.

Sectional Door Assembly (ICC 500)

A vertically operating door made of two or more horizontal sections hinged together, operating by means of tracks and track rollers at the jambs.

Special Inspection (ICC 500)

Inspection of construction requiring the expertise of an approved special inspector in order to ensure compliance with the ICC 500 standard and the approved construction documents.

Special Inspector (ICC 500)

A qualified person employed or retained by an approved agency and approved as having the competence necessary to inspect a particular type of construction requiring special inspection.

Specimen (ICC 500)

The entire assembled unit submitted for testing, including but not limited to anchorage devices and structure to which the product is to be mounted.

Storm Shelter (ICC 500)

A building, structure, or portion thereof, constructed in accordance with this standard, for protection from tornadoes, hurricanes, and other severe windstorms.

- **Community Storm Shelter (ICC 500).** Any storm shelter not defined as a residential storm shelter. This includes both storm shelters intended for use by the general public and storm shelters intended for use by building occupants or a combination of both.
- **Residential Storm Shelter (ICC 500).** A storm shelter serving occupants of dwelling units and having a storm shelter design occupant capacity not exceeding 16 persons.

Storm Surge Flood (ICC 500)

The flooding associated with the maximum storm surge inundation associated with the maximum intensity hurricane modeled using an *approved* source such as the National Hurricane Center's Sea, Lake and Overland Surges from Hurricanes (SLOSH).

Storm Surge Flood Elevation (ICC 500)

The elevation corresponding to the *storm surge flood*, including coastal wave effects.

Storm Surge Flood Hazard Area (ICC 500)

The area subject to the *storm surge flood*.

T

Test Chamber (ICC 500)

An airtight enclosure of sufficient depth to allow unobstructed deflection of the *specimen* during pressure cycling, including ports for air supply and removal, and equipped with instruments to measure test pressure differentials.

Test Laboratory (ICC 500)

A testing agency accredited in accordance to conduct missile impact and static and cyclic pressure testing as required in ICC 500 Chapter 8.

Tornado Shelter (ICC 500)

A storm shelter specifically for use to protect occupants during tornadoes.

U

Usable Floor Area (ICC 500)

The portions of the floor area within the storm shelter envelope not including *occupant support areas*, used to determine the design *occupant capacity* of the storm shelter.

W

Wind Pressure (ICC 500)

See “Design Wind Pressure” and “Design Tornado Pressure.”

This page left blank intentionally

Chapter B3 Structural Design and Testing Criteria

This chapter uses Chapter 3 of ICC 500 as the referenced standard and includes a list of FEMA Funding Criteria that FEMA has identified as more conservative than the provisions in Chapter 3 of ICC 500. This chapter also includes FEMA additional guidance on structural design and testing of safe rooms based on many years of field observations and investigations related to safe room performance.

B3.1 Criteria

The structural design and testing of safe rooms should be in accordance with the provisions of Chapter 3 in ICC 500 as amended by FEMA's Funding Criteria as shown in Table B3-1.

FEMA Safe Room Grant Requirements

Whenever a safe room is constructed using FEMA grant funds, the FEMA Funding Criteria shown in Section B3.1 become requirements in addition to the requirements of ICC 500 Chapter 3.

Table B3-1: Comparison of ICC 500 Requirements to FEMA Funding Criteria

ICC 500 Reference	ICC 500 Requirements ^(a)	FEMA Funding Criteria ^(b)
Section 302.1 Load Combinations, General	The storm shelter shall be designed to resist the load combinations specified in Section 302.2 or 302.3. <i>Storm shelters</i> that are designed as combination tornado and <i>hurricane shelters</i> shall comply with requirements for both sets of load combinations using either Section 302.2 or 302.3.	For all residential safe rooms, only the tornado shelter load combinations specified in Section 302.2 or 302.3 are required to be applied, regardless of safe room type, tornado, hurricane, or combination.
Section 304.1 Wind Loads, General	Tornado loads, W_T , wind loads for hurricanes, W_H , and wind loads for storms in Alaska, W_H , shall be determined in accordance with ASCE 7, Chapters 26 through 32, except as modified by this section. For tornado loads, the procedures from ASCE 7 Section 32.1.2 shall be applicable.	For all residential safe rooms, only tornado loads, W_T, are required to be applied, regardless of safe room type, tornado, hurricane, or combination.
Section 304.2 Design tornado speed	For tornado shelters, the storm shelter design tornado speed, V_T , shall be in accordance with Figure 304.2(1).	For all residential safe rooms, the design tornado speed, V_T, is required to be 250 mph, regardless of geographic location and type of safe room, tornado, hurricane, or combination.

PART B

ICC 500 Reference	ICC 500 Requirements ^(a)	FEMA Funding Criteria ^(b)
Section 304.3 Design wind speed	For hurricane shelters, the storm shelter design wind speed, V_H , shall be in accordance with Figure 304.3(1) through 304.3(3). For storm shelters in Alaska the design wind speed, V_H , shall be in accordance with Figure 304.3(4). ^(c)	For all residential safe rooms, the design tornado speed, V_T, is required to be 250 mph, regardless of geographic location and type of safe room, tornado, hurricane, or combination.
Section 304.9, Storm shelters connected to host buildings	Where a structural element of the host building is connected to a storm shelter, the storm shelter shall be designed to resist the maximum force that could be transmitted to the storm shelter equal to the ultimate failure strength of the connection or element being connected, whichever is lower, concurrent with the other wind loads on the storm shelter required by Chapter 3.	Where an element or component of the <i>host building</i> is connected to a safe room, the safe room shall be designed to resist the maximum force that could be transmitted to the <i>safe room</i> equal to the ultimate failure strength of the connection or element being connected, whichever is lower, concurrent with the other wind loads on the <i>safe room</i> required by Chapter 3. ^(d)
Section 305.1 Wind-borne debris	All <i>storm shelters</i> shall be designed for the impact loads of wind-borne debris in accordance with Section 305.1.1 through 305.2.2.	For all residential safe rooms, only the tornado shelter missile criteria for a design tornado speed of 250 mph are required to be applied, regardless of safe room type, tornado, hurricane, or combination.
Section 306.4.1 Impact-protective systems	<i>Impact-protective systems</i> for use in the <i>storm shelter envelope</i> shall be tested, listed, and labeled for impact in accordance with Section 803 and static and cyclic pressure in accordance with Sections 804 and 805. Any changes to listed <i>impact-protective systems</i> , such as a change of glazing, shall require evaluation by the listing agency or retesting of the entire assembly.	For all residential safe rooms, only the tornado shelter impact test criteria of Section 803 and only the tornado shelter static pressure test criteria of Sections 804 and 805 are required to be applied, regardless of safe room type, tornado, hurricane, or combination.

Bolded text denotes differences between the ICC 500 Requirement and the FEMA Funding Criteria.

Notes:

- (a) ICC 500 language reprinted here with permission from the International Code Council.
- (b) Table only lists requirements where there are differences between FEMA Funding Criteria and ICC 500 Chapter 3. All ICC 500 Chapter 3 requirements not listed in the table should also be met in their entirety. Safe room types (e.g., community, residential, tornado, hurricane) outside the scope of any given FEMA Funding Criterion need only meet the corresponding ICC 500 criteria (where applicable).
- (c) ICC 500 tornado storm shelter design wind speeds range from 130 mph to 250 mph; the range for hurricane storm shelters is 160 mph to 235 mph; the range for storm shelters in Alaska is 130 mph to 185 mph.
- (d) The noted FEMA Funding Criteria apply to all safe rooms.

B3.2 FEMA Additional Guidance

FEMA offers the following background information and guidance for the criteria referenced in ICC 500 Chapter 3 or presented as FEMA Funding Criteria in Section B3.1.

B3.2.1 FEMA FUNDING CRITERIA: STRUCTURAL DESIGN AND TESTING FOR SAFE ROOMS

While ICC 500 allows all storm shelters to be designed in accordance with the hazard-specific design wind speed (ICC 500 Figures 304.2(1) and 304.2(2)), FEMA requires that all FEMA-funded residential safe rooms be designed to resist tornado wind loads based on a 250 mph design wind speed (see Table B3-1). With small residential safe rooms, the cost differential associated with designing and constructing the safe room to resist a worst-case event is far less significant than for community safe rooms, which are typically larger.

FEMA also applies the tornado impact testing criteria for the 250 mph wind zone to all FEMA-funded residential safe rooms. FEMA Funding Criteria differ from ICC 500, which allows residential storm shelters and storm shelter components to meet the impact criteria required for the storm shelter design wind speed where it is to be constructed or installed. Depending on the area, this design wind speed could be lower than the worst-case scenario tornado wind speed of 250 mph. Typical residential safe rooms have fewer envelope penetrations than community safe rooms, so the cost differential associated with uniform worst case impact criteria is less significant.

Residential tornado and hurricane safe room impact-protective systems (e.g., door assemblies) should be tested for impact and static pressure loads based on tornado loads for the 250 mph tornado safe room design wind speed. In addition, Section 306 of ICC 500 requires cyclic pressure testing for all hurricane storm shelter impact protection systems be performed on the same sample that underwent impact testing.

Using the FEMA Funding Criteria wind speeds, associated pressures, and testing methods helps to offset increased residential safe room risk that can result from potentially less stringent design, construction, and installation oversight. FEMA's requirement may also negate the potential use of prefabricated safe rooms designed to lesser wind speeds from being used in areas with higher wind speeds.

In addition to FEMA Funding Criteria specific to residential safe rooms, this edition of FEMA P-361 includes new FEMA Funding Criteria that apply to ICC 500-2023, Section 304.9, "Storm shelters connected to host buildings." To limit unintended loading of the safe room, connections from the host building to the safe room envelope should be avoided wherever possible regardless of whether the connection is intended to transfer structural loads or not. Therefore, safe room designers should be prepared to demonstrate that the safe room envelope has been designed to resist the maximum force that could be transmitted to the safe room equal to the ultimate failure strength of the connection or element being connected, whichever is lower, concurrent with the other wind loads on the safe room required by ICC 500 Chapter 3.

B3.2.2 GENERAL APPROACH TO THE STRUCTURAL DESIGN OF SAFE ROOMS (REFERENCE: ICC 500 SEC 301)

The design criteria presented in this chapter are based on the most current information available as of the date of publication of this edition of FEMA P-361. The wind loads and tornado loads a safe room is designed to resist are primarily based on the load determination criteria in ASCE 7, with modifications as required by ICC 500 and in some cases, additional changes as described in Section B3.1. ICC 500 modifies some of the other loads, e.g., rain loads and roof live loads, beyond the requirements of ASCE 7 and the IBC. Wind loads should be combined with the appropriate gravity loads and other prescribed loads acting on the safe room as required by the load combinations presented in Chapter 3 of ICC 500 and described in Section B3.2.3.

NOTE

Wind and Tornado Terminology

This edition of FEMA P-361 introduces new terminology, “tornado speed” and “tornado load,” for consistency with ASCE 7-22 and ICC 500-2023. The new terms are intended to distinguish tornado characteristics from non-tornadic wind characteristics.

NOTE

Performance-Based Design Options

ICC 500-2023 adds performance-based design (PBD) options to Section 301 that reference ASCE 7-22 criteria in Section 26.1.3 for hurricane shelters and Section 32.1.3 for tornado shelters. Significantly, ICC 500 provides that storm shelter loads determined through PBD cannot be less than the minimum loads required in ICC 500.

Should a designer, builder, or manager have questions regarding the source of the governing structural design criteria for any given safe room, the following approach should be taken:

1. When questions arise pertaining to differences between FEMA Funding Criteria in FEMA P-361 and the ICC 500, the FEMA Funding Criteria should govern. If not, the safe room cannot be considered to be a FEMA-compliant safe room or satisfy FEMA HMA requirements for safe room funding.
2. When questions arise pertaining to design and construction criteria that are not addressed by the FEMA Funding Criteria in FEMA P-361, the ICC 500 criteria should govern.
3. For design and construction criteria not provided in FEMA P-361 or in the ICC 500, the applicable code should be used to determine the requirements for completing the safe room. In jurisdictions where no applicable codes are adopted, provisions of the edition of the IBC (or IRC where applicable) that is referenced in the latest edition of the ICC 500 should be applied.

4. Where the purpose of a safe room is to provide protection from both tornadoes and hurricanes, the entire safe room should be designed and constructed using the more conservative of the two sets of criteria.

For additional questions on safe room design criteria, contact FEMA's Safe Room Helpline by emailing saferoom@fema.dhs.gov.

B3.2.2.1 Design Considerations and Safe Room Types

This publication offers design guidance on two types of safe rooms:

- Stand-alone safe rooms
- Internal safe rooms

NOTE

Retrofits

The design professional performing retrofit storm shelter or safe room work on existing buildings should apply the new design guidance presented in this publication to the retrofit design.

The guidance in this publication is intended for the design and construction of new safe rooms, as well as for the addition of safe rooms to existing buildings by hardening an existing room or area (i.e., retrofitting). When considering retrofitting an existing building, the retrofit safe room must be designed to the same requirements and provide an equal level of protection as a new safe room. The wide variety of structural systems and large number of different configurations of existing buildings preclude a comprehensive review of all retrofit options, so limited guidance is provided (see Section A3.1.1) on modifying buildings to create a safe room where none previously existed. However, an RDP engaged in a safe room retrofitting project should be able to use the guidance in this publication to identify the appropriate hazards at the site, determine the risk, and calculate the loads acting on the building that is the subject of the safe room retrofit.

B3.2.2.1.1 Stand-Alone Safe Rooms

The results of the risk assessment discussed in Chapter A2 may show that the best solution for protecting large numbers of people is to build a new, separate (i.e., stand-alone) building to serve as a tornado or hurricane safe room.

Potential advantages of a stand-alone safe room include the following:

- The safe room can be constructed away from potential laydown or falling debris hazards
- The safe room will be structurally separate from any building and therefore not vulnerable to being weakened by way of connection or debris loading if part of an adjacent structure collapses
- The safe room does not need to be integrated into an existing building design

CROSS-REFERENCE

The information in Chapter A2, “Extreme-Wind Risk Assessment and Analysis,” may be useful in determining what type of safe room should be constructed.

B3.2.2.1.2 Internal Safe Rooms

The results of the risk assessment discussed in Chapter A2 may show that a safe room area specifically designed and constructed within or connected to a building is a more attractive alternative than a stand-alone safe room, especially when the safe room is to be used mainly by the occupants of the building. Potential advantages of an internal safe room include the following:

- The surrounding building may shield the safe room from storm effects that fall within the performance criteria of the applicable building code for the host building. Note, however, that any potential protection afforded by the surrounding building cannot be considered in the determination of wind loads and debris impact for safe room design.
- A safe room designed to be within a new building can be constructed in an area of the building that the building occupants can reach quickly, easily, and without having to go outside during the storm.
- Incorporating the safe room into a planned renovation or new building project may reduce the safe room cost.

One potential disadvantage of an internal safe room is the risk of host building or adjacent building debris collapsing or falling onto it. However, when this risk is properly considered by the RDP, a safe room constructed within a building is an acceptable application of the safe room concept. See next “Codes and Standards” text box for more information on how ICC 500 addresses considerations related to loading from the host structure; access considerations resulting from host structure debris around or atop the safe room—both ingress and egress—are described in Section B5.2.2.

CODES AND STANDARDS

ICC 500 includes distinctions between stand-alone (separate detached buildings) and internal (rooms or areas within buildings) storm shelters. Specifically, Sections 304.8 and 304.9 of the ICC 500, “Shielding of storm shelters by host and adjacent buildings” and “Storm shelters connected to host buildings,” respectively, provide that the host building or adjacent structures cannot be considered as protection to decrease wind or impact loading (i.e., must design shelter as if stand-alone) and that the storm shelter must be designed to resist the maximum force transmissible from host building structural connections.³ When the host building fails, portions of it connected to the storm shelter could potentially remain attached and cause added loading. The requirement is intended to ensure the connections between the host building and the storm shelter allow for the host building to break away and not compromise the storm shelter.

B3.2.2.2 Structural Systems and Building Envelope

The primary difference in a building’s structural system when designed for use as a safe room, as compared to conventional use, is the magnitude of the wind loads, tornado loads, and wind-borne debris it is designed to withstand. Safe rooms are designed for far greater wind speeds and tornado speeds (and corresponding far greater wind pressures and tornado pressures) and much larger and more robust energetic wind-borne missiles than conventional (normal) buildings.

Exterior glazing in conventional buildings is not required to resist wind-borne debris, except where the buildings are 1) located in the wind-borne debris regions within hurricane-prone regions, or 2) essential facilities required to be designed for tornado loads (see ASCE 7-22 Sections 26.12.3 and 32.12.2, respectively). ASCE 7 wind-borne debris criteria were developed to minimize property damage and improve building performance by reducing the risk of internal pressurization. But the criteria do not require unglazed doors, walls, and roofs to be debris impact-resistant. To provide a life-safety level of protection, the safe room design criteria include substantially greater resistance to penetration from wind-borne debris. The design of door and glazing assemblies of safe rooms are typically governed by wind-borne debris requirements (wind-borne debris causes many of the injuries and much of the damage from tornadoes and hurricanes).

To provide adequate life-safety protection, in addition to the glazing, the roof, wall, and door assemblies of a safe room must resist the specified wind-borne debris impacts. Sections B3.2.6.1, B3.2.6.2, and B3.2.6.3 present the debris impact-resistance performance criteria for tornado community safe rooms, hurricane community safe rooms, and residential safe rooms, respectively.

³ As described in Section B3.2.1, FEMA Funding Criteria specify that safe rooms must be designed to resist the maximum force transmissible from *any* host building to the safe room envelope connection.

B3.2.3 LOAD COMBINATIONS (REFERENCE: ICC 500 SEC 302)

For Strength Design (aka, Load and Resistance Factor Design [LRFD]), ICC 500 includes storm shelter-specific load combinations that were adapted from Section 2.3 of ASCE 7. Allowable Stress Design load combinations for storm shelters are also included in ICC 500 as adapted from the requirements in ASCE 7 Section 2.4. The storm shelter-specific load combinations were added to account for loading conditions anticipated during the extreme wind incident and include unmodified loads (dead loads and hurricane shelters floor live loads), as well as modified non-wind loads and wind loads as required by Sections 303 and 304, respectively. As such, the storm shelter or safe room must also be checked for “normal” loading conditions by using the load combinations required by the applicable code (e.g., IBC). For example, ICC 500 storm shelter load combinations do not include snow loads because tornadoes and hurricanes occur during warm weather. However, snow loads must be included as required by the applicable code when checking the non-storm shelter load combinations.

B3.2.4 NON-WIND LOAD CONSIDERATIONS (REFERENCE: ICC 500 SEC 303)

Section 303 of ICC 500 includes modifications to several types of non-wind loads, including rain loads, floor live loads, roof live loads, hydrostatic loads, and flood loads. Although seismic loads are unmodified for storm shelters and safe rooms by ICC 500 and FEMA Funding Criteria, guidance on seismic loads and detailing is also provided.

B3.2.4.1 Rain Loads

ICC 500 requires rain loads for structural design to be determined in accordance with the applicable code, but additionally specifies that the rainfall rate for hurricane shelters be determined by adding a rate of 6 inches per hour to the rainfall rate established in Figure 303.2 of ICC 500 or from approved local weather data. The rainfall rate maps in Figure 303.1.1 are from the International Plumbing Code® (IPC®) and correspond to the 100-year, 1-hour rainfall rate. The additional 6 inches per hour accounts for more intense rainfall rates possible in hurricanes and is intended to estimate the same MRI (10,000 years as described in Section B3.2.4.1) for rainfall that is used to generate hurricane safe room design wind speeds.

NOTE

Hurricane Storm Shelter and Safe Room Rain Load Factors

Although augmenting hurricane storm shelter rain loads by adding 6 inches of rainfall per hour to the 100-year, 1-hour rainfall rates has been required since ICC 500-2008, the 2023 edition is the first to reduce the load factor for rain loads to reflect that the prescribed rain loads are ultimate level loads rather than service level loads. The load factor reduction acknowledges that previous editions of the standard were overly conservative when requiring ultimate level load factors for rain loads while also requiring designers to increase the rain loads to amounts corresponding to the ultimate load.

The standard does not provide additional rain load requirements for tornado storm shelters, so tornado shelters and safe rooms are only required to comply with the applicable code for rain loads where required by the normal-use load combinations.

B3.2.4.2 Floor Live Loads

As noted in Section B3.2.3 the storm shelter-specific load combinations for hurricane storm shelters include floor live loads that are determined no differently than as required by the applicable code. This is because hurricane storm shelters are required to provide more floor area per occupant than the applicable codes require for non-shelter uses (see Section B5.2.1 for details). However, much less space is required for occupants of tornado storm shelters and safe rooms. As a result, ICC 500-2020 requires tornado storm shelter floor live loads to be no less than the applicable code requires for assembly occupancies.

B3.2.4.3 Roof Live Loads

ICC 500 requires roof live loads applied to the shelter to be as specified in the applicable code, but not less than 100 pounds per square foot for tornado shelters and not less than 50 pounds per square foot for hurricane shelters. In the event of a collapsing host building or other surrounding structures onto the safe room, roof live load conditions may well exceed the required minimum. Furthermore, impact loading from falling debris or laydown hazards may need to be taken under specific consideration as described in Section B3.2.6.5. As with all code- and standard-required minimum loads, it is important for designers to consider actual site conditions and increase minimum loads as appropriate.

Another type of roof live load, wheel loads for storm shelters subject to vehicular loading, are addressed in ICC 500 through reference to applicable requirements in ASCE 7, the IBC, and the IRC. Wheel loads should be applied to all in-ground safe rooms where vehicles may be parked on the shelter roof.

B3.2.4.4 Hydrostatic Loads

As noted in Section B4.2.3, unless in-ground safe rooms are properly anchored, buoyancy forces can push them out of the ground. Section 303.4 of ICC 500 includes hydrostatic load criteria that require any underground portions of storm shelters be designed to resist buoyancy and hydrostatic loads (as well as forces from saturated soils). Determination of hydrostatic load should be based on the assumption that the ground water level is equal to the ground surface at the entrance to the storm shelter, unless adequate drainage is available to justify designing for a lower ground water level. For additional guidance focused primarily on residential prefabricated safe rooms, refer to the *Foundation and Anchoring Criteria* Fact Sheet (2024b) on the FEMA Safe Room Resources webpage at <https://www.fema.gov/emergency-managers/risk-management/building-science/safe-rooms/resources>.

B3.2.4.5 Flood Loads

Flood hazard design criteria for safe rooms are addressed in Section B4.2.3. Note that these criteria define where a safe room may be sited and how high the lowest floor should be elevated where the safe room is sited in the special flood hazard area (SFHA), 500-year floodplain, or storm surge inundation area. FEMA recommends that safe rooms be sited outside of any area subject to flooding. For safe rooms that follow this recommendation, it is possible there would be no flood loads to consider. However, if the safe room meets all applicable siting criteria per Section B4.1 and has building elements (such as its foundation) below the design flood elevation, those elements should be designed in accordance with the flood loading provisions of the applicable code. The lowest floor used for safe room space and/or safe room support areas should be elevated to the higher of the minimum floor elevations described in Section B4.1, which should be used as the design flood elevation for flood load calculations. There are differences between the ICC 500 requirements and FEMA Funding Criteria related to determining the minimum floor elevation (refer to Section B4.1 for additional information). For safe rooms constructed with FEMA grant funds, the same elevation that governs the lowest floor of the safe room or safe room support area, should be used to determine flood depths for the safe room flood load calculations.

CROSS-REFERENCE

Refer to Section B4.1 for safe room minimum floor elevations.

B3.2.4.6 Seismic Loads and Seismic Detailing

In some locations around the United States, the risk of seismic events may be substantial enough that the building code requires seismic design and detailing. In some cases, the building code may require seismic detailing even when the structural design of the safe room is found to be controlled by the wind loads. Any seismic design and detailing requirements of the prevailing code or authority having jurisdiction must be met and should be reviewed for compatibility with other design parameters and prioritized according to the design program.

Wind and seismic loads differ in the mechanics of loading (i.e., the way the load is applied). Wind loads are generally applied on the exterior of the building envelope, and internal building elements that are not part of the building's MWFRS will not typically receive loads unless there is a breach of the building envelope. However, earthquakes induce loads based on force acceleration relationships. These relationships require that all objects of mass develop loads. Therefore, all structural elements and non-structural components within and attached to the structure will be loaded. As a result, seismic loading requires both exterior building elements and internal building elements (including non-load-bearing elements and fixtures) to be designed for the seismically induced forces.

B3.2.5 WIND LOADS AND DESIGN (REFERENCE: ICC 500 SEC 304)

To resist wind loads and tornado loads, safe room designs rely on the basic wind load and tornado load determination approaches taken in ASCE 7, with modifications as described in this section and

Section 304 of ICC 500. When wind loads and tornado loads are considered in the design of a building, lateral and uplift loads must be properly applied to the building elements along with all other loads.

B3.2.5.1 Design Wind Speeds for Safe Rooms

The prevailing wind hazard along the Gulf of Mexico and Atlantic coasts, in the Caribbean, and for some Pacific islands is a hurricane (some regions of the Pacific refer to hurricanes as “cyclones” or “typhoons”). Tornadoes are the greatest wind hazard in interior areas of the United States.

NOTE

Safe Room Design Wind Speed Maps

Tornado: The ICC 500-2023 design tornado speed map (Figure B3-1) is very similar to the map that first appeared in FEMA P-361 (2000). That map was slightly modified, subsequently adopted by ICC 500-08, and included in each edition of ICC 500 and FEMA P-361 since.

Hurricane: The ICC 500-2023 design hurricane wind speed map (Figure B3-2) is the same as ICC 500-2020 (see Section B3.2.5.1.3 for details). As with previous editions, FEMA P-361 has adopted the current ICC 500 map.

The maps in Figure B3-1 and Figure B3-2 present design tornado speeds for tornado safe rooms and design wind speeds for hurricane safe rooms, respectively. The four zones on Figure B3-1 have corresponding tornado speeds of 130 mph, 160 mph, 200 mph, and 250 mph. Similarly, Figure B3-2 shows the hurricane safe room design wind speed contours, which range from 160 to 220 mph for the U.S. mainland. Hurricane safe room design wind speeds are 165 mph in Hawaii and range from 190 mph to 235 mph across the U.S. Territories. As noted in Section B3.2.5.1.5 (see “Hurricane Probabilities”), the minimum design wind speed for hurricane safe rooms should serve to protect hurricane safe room occupants from tornadoes spawned by hurricanes.

The State of Alaska experiences extratropical coastal windstorms that have hazards similar to hurricanes, including extreme winds and storm surge. Therefore, safe rooms in Alaska are required to be designed using ICC 500 and FEMA P-361 hurricane criteria. Safe room design wind speeds for Alaska are shown in Figure B3-3 and range from 130 to 185 mph.

B3.2.5.1.1 Background on Safe Room Design Wind Speed Maps

Hurricane safe room design wind speeds are 3-second gust speeds at 33 feet above grade in Exposure C (flat, open terrain), which is consistent with the definition of basic wind speeds used in ASCE 7. Consequently, the safe room design wind speeds can be used in the wind pressure calculation formulas from ASCE 7 to determine wind loads, as required in ICC 500 Section 304. The hurricane safe room design wind speeds shown in Figure B3-2 are valid for most regions of the country. However, complex terrain and special features, such as mountainous terrain, and ocean promontories, are susceptible to local effects that may cause substantially higher wind speeds at

safe room sites. To address potential terrain-related increases, topographical speedup effects should be included through the use of K_{zt} factors as prescribed in ASCE 7.

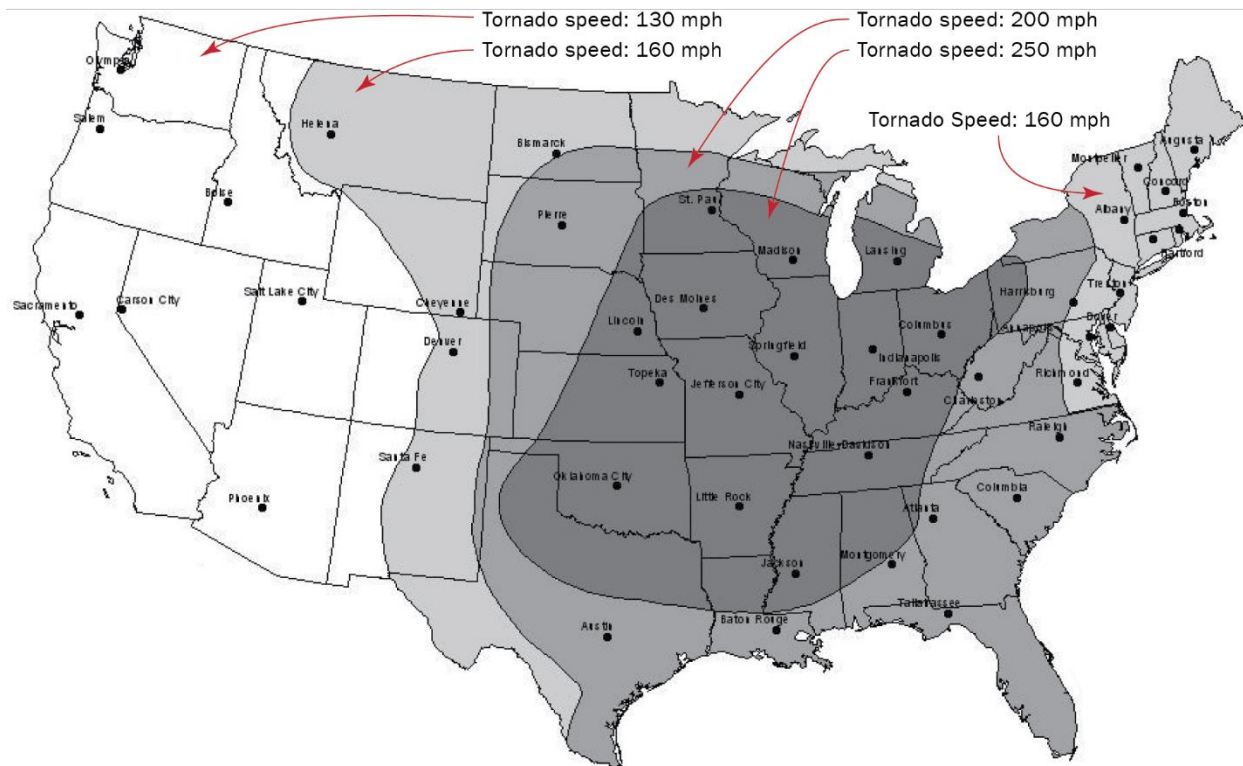

Figure B3-1: Safe room design tornado speed zones

SOURCE: ICC 500 (2023) FIGURE 304.2(1); USED WITH PERMISSION

Notes:

1. Values are nominal 3-second gust speeds in miles per hour at 33 feet above ground.
2. Multiply miles per hour by 0.477 to obtain meters per second.
3. Location-specific storm shelter design tornado speeds shall be permitted to be determined using the ATC Hazards by Location website, <https://hazards.atcouncil.org/>. ICC 500-2023 storm shelter design tornado speed map is unchanged, so the ATC Hazards website is still applicable for tornado safe rooms.

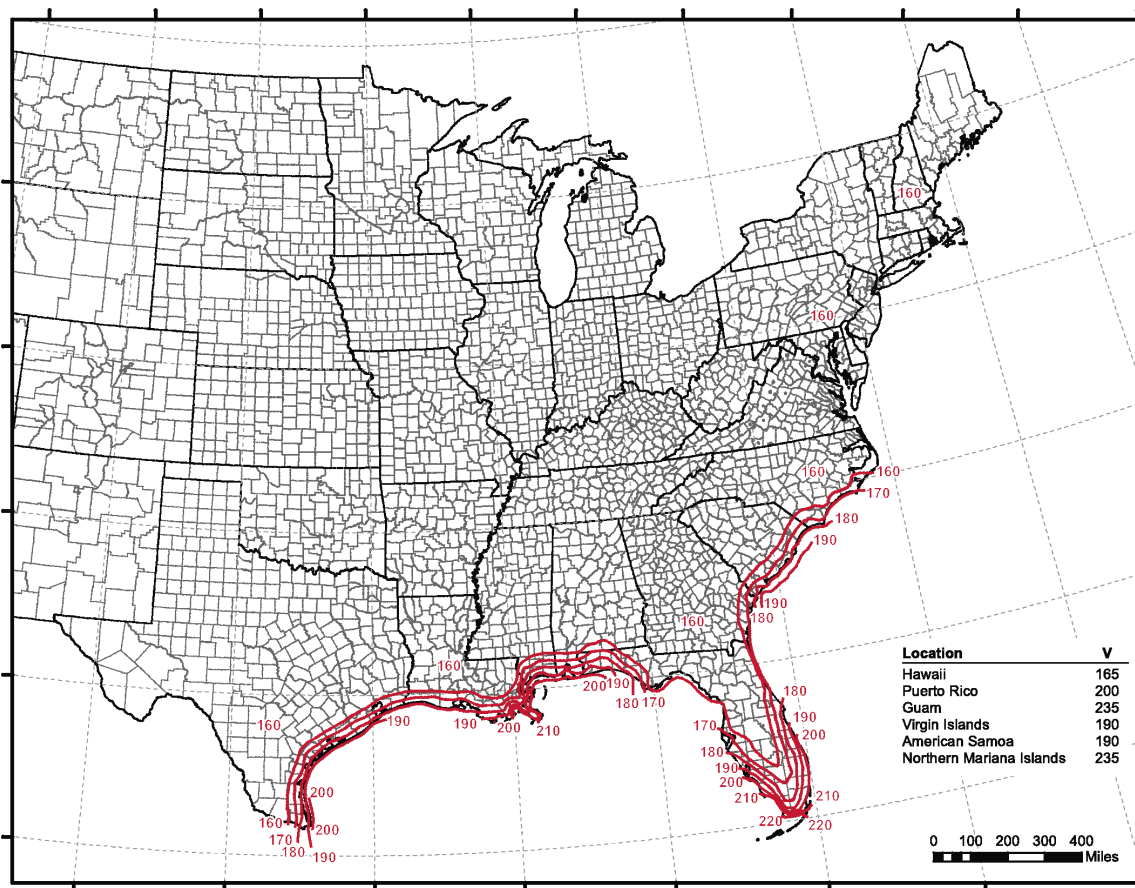

Figure B3-2: Safe room design wind speeds for hurricanes

SOURCE: ICC 500 (2023) FIGURE 304.2(2); USED WITH PERMISSION

Notes:

1. Values are nominal 3-second gust wind speeds in miles per hour at 33 feet above ground for Exposure C.
2. Linear interpolation between contours is permitted.
3. Islands and coastal areas outside the last contour shall use the last wind speed contour of the coastal area.
4. Multiply miles per hour by 0.447 to obtain meters per second.

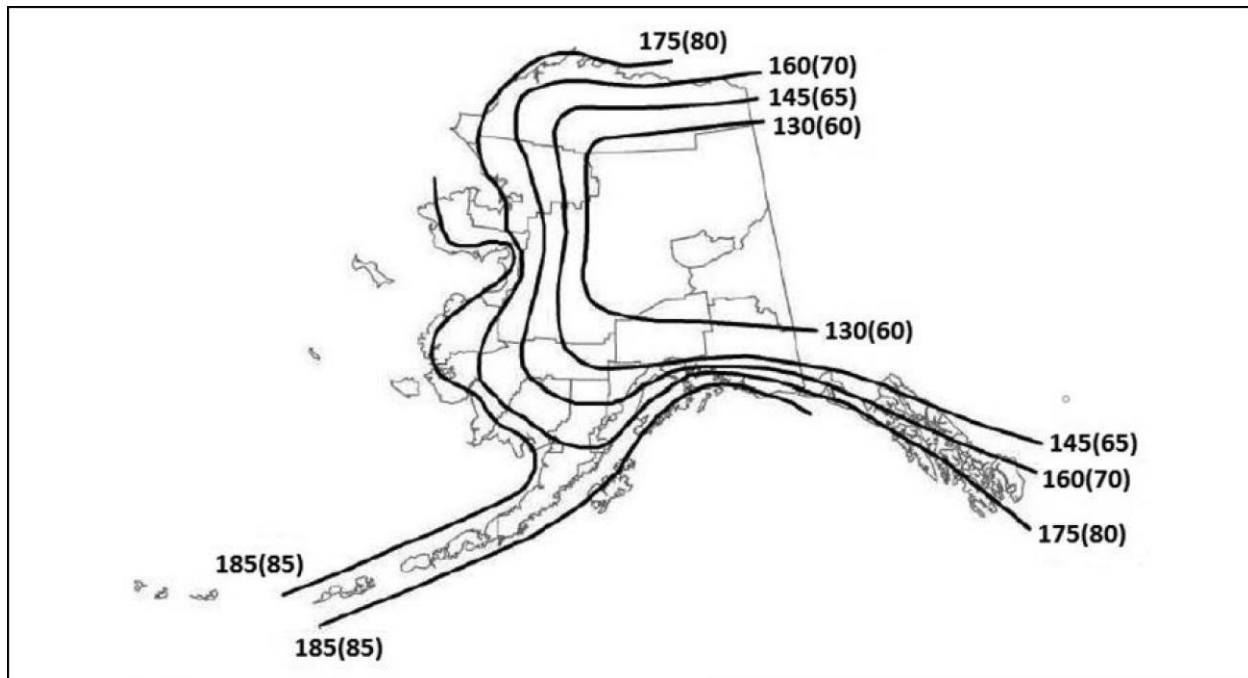

Figure B3-3: Safe room design wind speeds for Alaska

SOURCE: ICC 500 (2023) FIGURE 304.2(3); USED WITH PERMISSION

Notes:

1. Values are nominal 3-second gust wind speeds in miles per hour at 33 feet above ground for Exposure C.
2. Linear interpolation between contours is permitted.
3. Islands and coastal areas outside the last contour shall use the last wind speed contour of the coastal area.
4. Multiply miles per hour by 0.447 to obtain meters per second.

B3.2.5.1.2 Tornado Design Wind Speed Map (Reference: ICC 500 Sec 304.2)

The safe room design tornado speed map is shown in Figure B3-1, which is identical to the ICC 500 tornado design speed map. As described in this section, the map was developed from an analysis of historic tornadoes and represents a deterministic map of maximum tornadic wind speeds likely to occur in different regions of the country.

Development of the Safe Room Design Wind Speeds for Tornadoes

The NOAA Storm Prediction Center data used to develop the Figure B3-1 tornado speed zones covered the years 1950 through 2006. The current map is nearly identical to the first edition FEMA P-361 “design wind speeds for community shelters” map, which was developed in conjunction with TTU using data collected from 1950 through 1998. Tornado occurrence statistics prior to 1950 are available, but they are lower quality. From 1950 through 2006, a total of 49,296 tornadoes were recorded in the contiguous United States. Each of these tornadoes was assigned a Fujita Scale (F Scale) level. Table B3-2 shows the number of recorded tornadoes and percentages for each F Scale level, as well as the cumulative percentages. As noted in Table B3-2, less than 2% of the tornadoes were in the F4 category and less than 1% were in the F5 category.

CROSS-REFERENCE

Information on tornadoes, tornado hazards, and the Fujita and Enhanced Fujita Scales is presented in Section A2.1.1.

Table B3-2: Tornado Frequencies in the United States (1950–2006)

Fujita Scale Rating	Number of Tornadoes	Percentage	Cumulative (%)
F0	21,761	44.14	44.14
F1	16,873	34.23	78.37
F2	7,971	16.17	94.54
F3	2,143	4.35	98.89
F4	498	1.01	99.90
F5	50	0.10	100
Totals	47,449	100	

SOURCE: DATA IS FROM NOAA STORM PREDICTION CENTER

To develop wind speed zones, NOAA tallied the occurrences of tornadoes between 1950 and 2006 and plotted them on a grid map of the United States composed of 80-kilometer by 80-kilometer squares (2,470 square miles). Tornadoes rated using the F Scale were reclassified as EF Scale events (same corresponding scale number) and the number of EF4 and EF5 tornado occurrences within each 2,470-square mile square was tabulated for the whole country. These frequencies of occurrence data were used to develop the location of the zone boundaries shown in Figure B3-1.

NOTE

Historical Occurrences

There were 56,221 recorded tornadoes between 1950 and 2011. Of these, the NWS rated 95% as EF0–EF2, 4% as EF3, and 1% as EF4–EF5.

250 mph tornado speed zone: The 250 mph tornado speed zone includes all 2,470-square-mile grid squares with two or more EF5 tornadoes recorded between 1950 and 2006. The 250 mph zone also includes areas with 10 or more EF4 and EF5 tornado occurrences combined during this same period. In Figure B3-1, the darkest zone covers the middle part of the United States, where the most intense tornado damage has occurred.

200 mph tornado speed area: The 200 mph tornado speed area was developed using the statistics of EF3 tornado occurrences. Most areas with 20 to 30 EF3 tornadoes in a 2,470-square-mile grid square also had enough EF4 and EF5 tornadoes to be included in the 250 mph tornado speed zone. To be conservative, the 200 mph tornado speed zone was extended to cover areas where more than five EF3 tornadoes were identified within a single square. This zone extends along the Gulf and lower Atlantic coastal areas to include hurricane-generated tornadoes. A couple of grid squares in New York and Massachusetts fall outside of this zone even though they have more than five EF3 tornado occurrences. They are considered outliers and have had less than 10 EF3 occurrences.

160 mph tornado speed area: The 160 mph tornado speed area was developed for the remaining areas east of the Rocky Mountains. The western border for this zone approximately follows the Continental Divide. The 160 mph area covers all tornadoes of EF2 or lower intensity.

130 mph tornado speed areas: In the area west of the Rocky Mountains, there are relatively few tornado occurrences, and none have been rated EF5. From 1950 to 2006, only two tornadoes were rated EF4, and only 10 were rated EF3. For the 2008 edition of FEMA P-361, a wind speed of 130 mph was determined to be sufficient for this zone.

B3.2.5.1.3 Hurricane Design Wind Speed Map (Reference: ICC 500 Sec 304.3)

FEMA P-361 uses the shelter design wind speeds identified in Figure 304.3(1) of the ICC 500 as hurricane safe room design wind speeds (Figure B3-2). The ICC 500 map was developed using the same probabilistic methodology used to model hurricane wind speeds for the ASCE 7 wind speed maps, but for a 10,000-year MRI (0.5% probability of exceedance in 50 years). Hurricane safe room design wind speeds range from 160 to 235 mph.

CROSS-REFERENCE

Additional information on the Saffir-Simpson Hurricane Wind Scale is presented in Section A2.1.1.

Development of Hurricane Wind Speeds

The hurricane shelter design wind speed map used in the 2008 edition of ICC 500 was a 10,000-year MRI map generated using the hurricane simulation models described in Vickery et al. (2000) and Vickery et al. (2006), which were also used to create the hurricane contours in the ASCE 7-05 wind speed maps. When developing the first edition of the ICC 500 standard in 2008, the ICC 500 Storm Shelter Standard Committee considered wind speed maps with MRIs ranging from 1,700 to 10,000 years (1,700 years is the MRI associated with the ASCE 7-05 Occupancy Category IV buildings). Hurricane wind speeds were found to rapidly increase for lower MRI values and flatten out for higher MRIs (longer return periods). The committee decided that the 10,000-year MRI map was the most appropriate for hurricane shelters, given life-safety considerations and uncertainties in the estimation of wind speeds.

After a thorough review of the information used to prepare the initial ICC 500 hurricane shelter design wind speed map and coordination with the ICC 500 Standards Committee, FEMA adopted the ICC 500 hurricane storm shelter map for the second edition of FEMA P-361 (2008). (The first edition FEMA P-361 [2000] used a single design wind speed map for tornado and hurricane safe rooms). The second edition of ICC 500 and corresponding third edition of FEMA P-361 (2015) were based on the updated hurricane modeling methods used in the ASCE 7-10 standard. Improvements in the modeling process for ASCE 7-10 included improved representation of the hurricane wind field and new models for hurricane weakening after landfall, described in Vickery et al. 2010 and in Section C26.5.1 of ASCE 7-10. The net effect of the modeling improvements was a slight decrease in hurricane shelter design wind speeds in most locations, typically on the order of 5 to 10 mph.

The hurricane storm shelter design wind speed map referenced in the 2020 and 2023 editions of ICC 500 and this publication (as shown in Figure B3-2) is different from the 2014 edition. The current hurricane storm shelter and safe room design wind speed map still reflects the 10,000-year MRI but is based on further refinements to the hurricane model and updated climatology as the revised basic wind speed maps in ASCE 7-22. Unlike the previous editions in which models included historical hurricane track and landfall data from 1900 to 2006, the updated model includes data through the 2018 hurricane season, which resulted in design wind speed increases along the Texas and north Florida Gulf Coasts and design wind speed decreases in some areas of the Northeast.

B3.2.5.1.4 Wind Speeds for Alaska

The State of Alaska does not get hurricanes and is not prone to tornadoes, but it does experience extratropical cyclone winds and thunderstorms. As such, the safe room design wind speeds for Alaska were moved to a separate design wind speed map in ICC 500-2020. Aside from the separate design wind speed map, the standard and this publication now specify that Alaskan storm shelters or safe rooms comply with hurricane shelter or safe room criteria, respectively. Rationale for the change acknowledged that while extratropical cyclones are not hurricanes, they are more similar to hurricanes than tornadoes with respect to storm duration and the potential for coastal flooding and increased rain loading. The safe room design wind speed contours were taken from ASCE 7-16 Figure CC-3 (50-year MRI for serviceability considerations). The wind speed values represented by the contours were increased to approximate the 10,000-year MRI using the approach described in ASCE 7-16 Chapter C26.5 (equation C26.5-1). As a result of the modified approach, safe room design wind speeds along the coast of Alaska increased from 160 mph to 175 and 185 mph. Safe room design wind speeds for Alaska are shown in Figure B3-3.

B3.2.5.1.5 Design Wind Speeds and Near-Absolute Protection

The design wind speeds and tornado speeds chosen by FEMA for safe room guidance were determined with the intent of specifying near-absolute protection with an emphasis on life safety. Historically, most tornado deaths have occurred during tornadoes classified as F3/EF3, F4/EF4, or F5/EF5. While the number of fatalities per single tornado increases steadily with EF number, the total number of tornado fatalities is 1,334 for EF3 tornadoes; 2,384 for EF4 tornadoes; and 1,347 for EF5 tornadoes during the period of 1950 to 2019. Together, just over 85% of tornado fatalities

between 1950 and 2019 were from EF3, EF4, or EF5 tornadoes. For hurricanes, the largest storms have typically been the deadliest; however, most hurricane deaths are associated with storm surge inundation, not high winds. For both hazards, such intense storms are rare. Even in those areas of the middle of the country where the risk of EF4 and EF5 tornadoes is greatest, the likelihood that a particular building will be struck by an EF4 or EF5 tornado is extremely low. Though rare, safe room design must stand up to these extremely rare events if they are to provide near-absolute protection. Furthermore, community safe rooms protect occupants coming from surrounding buildings and neighborhoods, so the area protected is much greater than the area of the single building.

Tornado Probabilities

Tornado probability estimates have been based on historical records of tornado observations and classifications within large areas surrounding the site. These areas have ranged from 80-kilometer (49.71 miles) by 80-kilometer (49.71 miles) squares to 1 degree latitude and longitude squares. Consequently, they are subject to considerable uncertainty, particularly for the rare EF4 and EF5 storms. Although analysis of historical records provides some insight into areas of the United States where there is higher risk of tornado activity, the length of the historical records is relatively short; furthermore, tornado intensity has been determined through observed damages, so tornadoes in areas with lower populations may have gone undetected, unrated, or underrated. RDPs should understand that the safe room design wind speed zone boundaries on the map shown in Figure B3-1 were developed using a deterministic analysis based on the relatively low number of observations and large variability in reporting. Given the imprecision of tornado safe room design wind speed zone boundaries, designers are advised to choose the higher wind speed when designing tornado safe rooms sited near a map zone boundary.

Measuring Tornado Intensity

EF Number	Wind Speed (3-second gust)
EF0	65-85 mph
EF1	86-110 mph
EF2	111-135 mph
EF3	136-165 mph
EF4	166-200 mph
EF5	>200 mph

SOURCE: NOAA, <https://www.spc.noaa.gov/efscale/ef-scale.html>
 EF=Enhanced Fujita
 mph = miles per hour

During development of the EF Scale, tornado speeds were reanalyzed to better correlate with observed damages. The reanalysis resulted in a decrease in tornado speeds assigned to EF Scale-rated events in comparison with F Scale-rated events. ICC 500 uses the 250 mph 3-second gust design tornado speed for the areas with greatest risk from the most intense tornadoes, which corresponds to the fastest estimated⁴ tornado speeds occurring within close proximity to the ground. A 250 mph wind speed is near the upper end of the F4 Scale and would be considered a strong EF5 tornado. This approach provides a conservative design wind speed for the riskiest region and allows reductions in design tornado speeds for other tornado-prone areas based on relative risks. The lowest safe room design tornado speed east of the Rocky Mountains is 160 mph, near the top of the EF3 range.

Hurricane Probabilities

The hurricane shelter design wind speeds in the ICC 500 standard represent an MRI of 10,000 years. This corresponds to a 0.01% annual probability of exceedance, or 0.5% probability of exceedance in 50 years, and provides a consistent risk-based design approach for hurricane storm shelters and safe rooms. Even though the odds of exceeding the hurricane safe room design wind speed for any given site are remote, powerful hurricanes still strike and affect large areas.

The lower limit of the hurricane safe room and shelter design wind speed was set by ICC at 160 mph, which is close to the upper tornado speed limit of an EF3 tornado. Because nearly all observed tornadoes spawned by hurricanes have been classified as EF3 or lower, this lower limit is a reasonable and conservative design criterion for safe rooms intended for use during a hurricane.

B3.2.5.2 Calculating Wind and Tornado Loads

The following section provides guidance on steps taken to calculate wind loads or tornado loads for any safe room by examining safe room design parameters, application of the ASCE 7-22 methodologies, and how to combine different wind load or tornado load effects that act simultaneously on the building. It is important for designers to remember that other effects, such as debris impact, may control the design of an element rather than the direct wind pressure.

The wind load or tornado load design methodology for the MWFRS described in this publication is based on the use of the ASCE 7-22 “Directional Procedure” with additional modifications of specific coefficients as specified in ICC 500 and in this publication. Designers are permitted to use the ASCE 7-22 “Envelope Procedure” (Chapter 28) for hurricane safe rooms only and “Wind Tunnel Procedure” (Chapter 31) for all safe rooms subject to the ASCE scope limits for each procedure. When designing hurricane safe rooms, the provisions of the ASCE 7-22 “Directional Procedure” and the “Envelope Procedure” should not be combined or mixed (e.g., the designer should not use the “Directional

⁴ Damage-based estimates only. Doppler radar was used to estimate wind speeds of approximately 300 mph for El Reno, Oklahoma (2013) and Moore, Oklahoma (2013) tornadoes (Samenow, 2013).

Procedure” to calculate hurricane safe room lateral loads and the “Envelope Procedure” to calculate hurricane safe room uplift on the roof).

As required by ICC 500 Section 304.8, Shielding of storm shelters by host or adjacent buildings, designers should not reduce the calculated wind pressures or assume a lower potential for wind-borne debris impacts on the exterior walls and roof surfaces of an internal safe room. Although a safe room inside a larger building or otherwise shielded from the wind is less likely to experience the full wind pressures and wind-borne debris impacts, it should still be designed for the design wind pressures and potential wind-borne debris impacts that would apply to a stand-alone safe room. This is because it should be assumed that the structure surrounding the internal safe room and any adjacent structures providing shielding may sustain significant damage or collapse in extreme-wind events, thereby offering no protection to the safe room.

B3.2.5.2.1 Parameters for Calculating Wind and Tornado Pressures

Structural design assumptions and procedures for normal-use buildings are not always appropriate for safe rooms. As a result, when calculating the velocity pressure, MWFRS wind and tornado pressures, and components and cladding (C&C) wind and tornado pressures for safe rooms using Formulas B3-1, Formulas B3-2, and Formulas B3-3 (see next subsection), the following parameters require adjustment as described later in this section: site exposure category, directionality factor, and topographic factor.

For combined hazard safe rooms (i.e., safe rooms for protection from both tornadoes and hurricanes), the design should be governed by the more conservative site- and hazard-specific criteria. Note that when determining design wind pressures and design tornado pressures, the hazard with the greater design speed may not necessarily control the design because wind speed or tornado speed is just one of many parameters that affect the resulting design pressures. Minimum design safe room pressures for both hazard types should be analyzed to ensure the design is capable of resisting the greatest loads applied by each. A similar comparative analysis should be conducted for all other loads, all the way through determination of load combinations, as some non-wind/non-tornado loads are different for the two storm types (such as roof live loads, rain loads, and flood loads). For safe room missile impact criteria (refer to Section B3.2.5), ICC 500 Section 306.1 permits storm shelter envelope components that meet the highest tornado shelter missile impact criteria to be considered acceptable for hurricane shelters provided they meet the structural load requirements for hurricane shelters.

B3.2.5.2.2 Using the ASCE 7 Directional Procedure

The equations for the “Directional Procedure” are shown here so they can be explained in more detail. The velocity pressure equation for hurricane safe rooms (Equation 26.10-1, ASCE 7-22) is shown along with the tornado velocity pressure equation for tornado safe rooms (Equation 32.10-1, ASCE 7-22) in Formulas B3-1. The design wind pressure equation for hurricane safe room MWFRS (Equation 27.3-1, ASCE 7-22) and the tornado pressure equation for tornado safe room MWFRS (Equation 32.15-1, ASCE 7-22) are shown in Formulas B3-2. Lastly, the design wind pressure for

hurricane safe room C&C (Equation 30.3-1, ASCE 7-22) and the design tornado pressure for tornado safe room C&C (Equation 32.17-1, ASCE 7-22) are shown in Formulas B3-3. The following sections include guidance to assist designers in choosing values needed to generate wind pressures to be resisted by the safe room for life-safety protection.

Velocity Pressure Calculation: Formulas B3-1T and B3-1H

The velocity pressure, q_{zT} , for tornado safe rooms is a function of height above ground, ground elevation factor, and tornado speed (Formula B3-1T). The velocity pressure, q_z , for hurricane safe rooms is a function of height above ground, exposure category, topographic conditions, ground elevation factor, and wind speed (Formula B3-1H). The velocity pressure exposure coefficient (K_z) factor accounts for the boundary layer effects of wind flowing close to the surface of the earth where it interacts with the terrain, buildings, and vegetation. The following section provides guidance on selecting the appropriate site exposure category (factor of K_z), topographic factor, and required safe room directionality factor of 1.0

Formula B3-1T: Tornado Velocity Pressure

$$q_{zT} = 0.00256K_{zTor} K_e V_T^2 \quad (\text{Tornado safe room})$$

Formula B3-1H: Velocity Pressure

$$q_z = 0.00256K_z K_{zt} K_e V^2 \quad (\text{Hurricane safe room})$$

where:

- q_{zT} = tornado velocity pressure (psf) calculated at height z above ground
- K_{zTor} = tornado velocity pressure exposure coefficient at height z above ground
- K_e = ground elevation factor
- V_T = safe room design tornado speed (mph) (from Figure B3-1)
- q_z = velocity pressure (psf) calculated at height z above ground
- K_z = velocity pressure exposure coefficient at height z above ground
- K_{zt} = topographic factor
- V = safe room design wind speed (mph) (from Figure B3-2)

Tornado Velocity Exposure Pressure Coefficient: Values of the tornado velocity exposure pressure coefficient (K_{zTor}) are presented in tabular form in ASCE 7 Chapter 32 as a function of height above ground only. Unlike the non-tornadic velocity pressure exposure coefficients for Exposures B or C that increase with height above ground level, tornado velocity exposure pressure coefficients are uniform below 200 feet above ground level and decrease slightly above that height.

Ground elevation factor: The effect of ground elevation on air density is independent of windstorm type, so no changes are recommended to the ASCE 7 ground elevation provisions when calculating velocity pressures for safe rooms of any type.

Velocity Exposure Pressure Coefficient: Values of the velocity pressure exposure coefficient (K_z) are presented in tabular form in ASCE 7 Chapter 26 as a function of terrain exposure and height above ground. Notably, exposure category requirements for tornado storm shelters were removed from ICC 500-2023 because ASCE 7-22 Chapter 32 does not apply exposure category to determine tornado loads.

Hurricane: For hurricane safe rooms, the use of Exposure B (urban, suburban, and wooded areas) is not permitted except in very limited circumstances, so Exposure Category C (open terrain) or Exposure Category D (near a large body of water) should be applied in most cases. Exposure Category B is permitted only in the design of the MWFRS and only if Exposure Category B exists for all wind directions and is likely to remain Exposure Category B after a hurricane of the intensity corresponding to the hurricane safe room design wind speed.

Topographic factor: The topographic factor (K_{zt}) in ASCE 7 is based on the acceleration of straight-line winds over hills, ridges, or escarpments. Similar to the velocity pressure exposure coefficient described above, topographic factor requirements for tornado storm shelters were removed from ICC 500-2023 because ASCE 7-22 Chapter 32 does not apply a topographic factor to determine tornado loads.

Hurricane: For hurricane safe rooms, designers should carefully consider the increased loads associated with siting safe rooms in locations that are likely to experience topographic effects. If siting a hurricane safe room on a hill, ridge, or escarpment is necessary, requirements given in ASCE 7 for the topographic factor should be used. Although topographic speedup factors are incorporated in the site-specific basic wind speeds provided through the ASCE 7 Hazard Tool for Hawaii, Puerto Rico, and the U.S. Virgin Islands, the geodatabase is limited to MRIs corresponding with Risk Category I through IV structures, which are associated with more frequent events and not the extreme events that safe rooms are designed to withstand. As a result, ASCE 7 Hazard Tool microzoned wind speed values are no longer recommended to be leveraged to back-calculate topographic factors for hurricane safe rooms.

Safe room design tornado speed or design wind speed: For community safe rooms, the ICC 500 design tornado speed and design wind speed maps reproduced in Figure B3-1 and Figure B3-2 should be used to determine the design tornado speeds for tornado safe rooms and the design wind speeds for hurricane safe rooms, respectively. FEMA requires that all FEMA-funded residential safe rooms be designed to resist tornado safe room loads based on a 250 mph design wind speed (see Table B1-1) as described in Section B3.2.1.

Tornado: As noted in Chapter A2, the ICC 500 tornado wind speed map (Figure B3-1) does not show a high level of detail; therefore, when a safe room is to be sited and constructed near a tornado speed zone boundary, the design tornado speed may not be clear. Designers and code officials should recognize that the mapped design tornado speed zone boundaries are not drawn or intended to be interpreted as precise geographic coordinates. When planning or designing safe rooms, it is important to remember the intended purpose of a safe room is to protect people

from death or injury. Accordingly, a prudent approach would assume that the site in question falls within the higher tornado speed zone.

Hurricane: In addition to the hurricane safe room design wind speed map shown in Figure B3-2, ICC 500 also provides regional maps showing the same hurricane wind contours at a larger scale, which allows users to more easily locate safe room sites and interpolate, as needed.

The hurricane safe room design wind speeds shown in Figure B3-2 are valid for most regions of the country. However, complex terrain and special features, such as mountainous terrain and ocean promontories, may cause substantially higher wind speeds at safe room sites. To address potential terrain-related increases for hurricane safe rooms, topographical speedup effects should be included through the use of K_{zt} factors prescribed in ASCE 7.

Pressure on MWFRS Calculation: Formulas B3-2H and B3-2T

Once velocity pressure is determined using Formulas B3-1T and B3-1H, wind pressures are determined for MWFRS and C&C elements using Formulas B3-2T and B3-2H and Formula B3-3T and B3-3H, respectively. The only major difference in calculating MWFRS and C&C pressures for safe rooms when compared with normal buildings (beyond differences in the velocity pressure described previously) is in assignment of the enclosure classification and the related internal pressure coefficients. The following section provides guidance for making this critical determination.

Formula B3-2T: Pressure on MWFRS for Low-Rise Buildings

$$p_T = qG_T K_{dT} K_{vT} C_p - q_i (GC_{piT}) \quad (\text{Tornado safe room})$$

Formula B3-2H: Pressure on MWFRS for Low-Rise Buildings

$$p = qK_d G C_p - q_i K_d (GC_{pi}) \quad (\text{Hurricane safe room})$$

where:

p_T = tornado pressure (psf)

$q = q_z$ for windward walls calculated at height z above ground

$q = q_h$ for leeward walls, sidewalls, and roofs evaluated at height h

G_T = tornado gust-effect factor

K_{dT} = tornado directionality factor = 1.0

K_{vT} = tornado pressure coefficient adjustment factor

C_p = external pressure coefficients

GC_{piT} = tornado internal pressure coefficient

p = pressure (psf)

K_d = wind directionality factor = 1.0

G = gust-effect factor

$q_i = q_h$ = velocity pressure calculated at mean roof height

GC_{pi} = internal pressure coefficients

Internal pressure coefficient and enclosure classification: The internal pressure coefficients (GC_{piT} and GC_{pi}), which incorporate the gust effect factor, account for internal pressure due to normal leakage of air entering or exiting the building in addition to situations in which there are large openings in the building envelope. This leakage creates a pressure increase or a decrease within the building. The tornado internal pressure coefficient (GC_{piT}) also includes the effects of atmospheric pressure change (APC).

ICC 500 requires that a community storm shelter's enclosure classification be determined in accordance with ASCE 7, provided that the largest wall opening that is protected by an impact-protective system is considered an opening. This provision accounts for the possibility that even an appropriately tested, installed, maintained, and operated pressure- and impact-rated assembly (e.g., door, window, shutter) may fail if struck by a larger or more damaging missile than it was designed and tested to resist.

This provision also accounts for potential problems due to improper maintenance of impact-protective systems; improper operation (e.g., incomplete closure or latching) prior to and during a storm; and purposeful opening during a storm. Many such cases have been documented (AAWE, 2004). There are documented instances where impact-protective systems (shutters) were improperly latched or unlocked because keys were unavailable. In other instances, doors were deliberately opened to admit late arriving occupants or for other reasons (e.g., to allow movement between different shelter areas or the observation of damage conditions, let in fresh air, let out people who wanted to smoke), and in some of those cases, before the doors were re-latched or locked, they were compromised by strong gusts.

Tornado safe rooms must also meet the APC venting requirements of ICC 500 Section 304.7 unless designed as partially enclosed with internal pressure coefficient, GC_{piT} , set at ± 0.55 . The following design guidance should be considered when selecting the appropriate safe room internal pressure coefficient.

Tornado: In tornadic events, maximum external tornado pressures should be combined with pressures induced by APC if the building is sealed or, like most safe rooms, nearly sealed. Although ventilation is needed to ensure that safe room occupants have sufficient airflow to remain comfortable, the minimum ventilation requirements in ICC 500 Chapter 7 are not sufficient to nullify APC-induced pressures. In order to meet the minimum APC venting requirements provided in ICC 500 Section 304.7, most community tornado safe room designs would require a significant number of openings in the safe room envelope, which could create an uncomfortable environment for occupants during tornadoes. In accordance with the exception to ICC 500 Section 304.7, tornado storm shelter designers may forego the prescriptive additional venting requirements to alleviate APC-induced pressures provided tornado design pressures are determined using partially enclosed classification values for tornado internal pressure coefficients ($GC_{piT} = \pm 0.55$). Designing tornado safe rooms using partially enclosed classification is recommended over APC venting to simplify design, enhance structural reliability, reduce vulnerability to wind-borne debris (i.e., fewer safe room envelope openings), and improve the community safe room environment during tornadoes.

Hurricane: In hurricane events, tornadic vortices are often embedded in the overall storm structure. Although these tornadoes are typically smaller and less intense than tornadoes occurring in the interior of the country, swaths of damage reminiscent of tornado damage have been noted in several hurricanes.⁵ In addition to increased pressures related to possible tornadoes during hurricane events, the likelihood of component failure resulting from improper door operation increases with the period of safe room occupancy. **BEST PRACTICE: To enhance structural reliability, community and residential safe rooms can be designed using a GC_{pi} value of ±0.55.**

Gust effect factor and external pressure coefficient: The gust effect factor depends on wind turbulence and building dimensions. The gust effect factor can be calculated (using Exposure C terrain exposure constants for G_T) or, for a rigid building, a value of G or $G_T = 0.85$ can be used, per Sections 26.11 and 32.11 of ASCE 7-22. The external pressure coefficient (C_p) for the design of the MWFRS (Formula B3-2H and B3-2T) is based on the physical dimensions and shape of the building, and the surface of the building in relation to a given wind direction. The process for selecting the external pressure coefficient to determine MWFRS pressures is the same for safe rooms as for normal use buildings.

Directionality factor: The directionality factor (K_d and K_{dT}) in ICC 500 and FEMA P-361 is conservatively set at 1.0. This is because wind directions may change considerably during a tornado or higher intensity hurricane, and a building may be exposed to intense winds from its most vulnerable direction. Therefore, the use of 0.85 for K_d in ASCE 7 for normal building design is not permitted by ICC 500.

Tornado pressure coefficient adjustment factor: The tornado pressure coefficient adjustment factor accounts for greater uplift pressures on roofs and some rooftop appurtenances that result from vertical winds within the tornado's core. The factor is applied in conjunction with the external pressure coefficients, which were developed for non-tornadic (boundary layer wind) conditions.

Pressure on C&C and Attachments: Formulas B3-3

One of the most common methods for calculating the loads for C&C and attachments is the use of the ASCE 7-22 Equation 30.3-1 in Chapter 30, "Part 1: Low-rise Buildings ($h < 60$ ft)," and Equation 32.17-1 in Chapter 32 shown here as Formula B3-3.

Formula B3-3H: Pressures on C&C and Attachments

$$p = q_h K_d [(GC_p) - (GC_{pi})] \quad (\text{Hurricane safe room})$$

Formula B3-3T: Pressures on C&C and Attachments

$$p_T = q_{hT} [K_{dT} K_{vT} (GC_p) - (GC_{piT})] \quad (\text{Tornado safe room})$$

⁵ Whether these swaths are caused by localized gusts or small-scale vortices is not known.

where:

p = pressure (psf)

q_h = velocity pressure calculated at mean roof height

K_d = wind directionality factor = 1.0

(GC_p) = external pressure coefficients

(GC_{pi}) = internal pressure coefficients

p_T = tornado pressure (psf)

G_T = tornado gust-effect factor

K_{dT} = tornado directionality factor = 1.0

K_{vT} = tornado pressure coefficient adjustment factor

GC_{piT} = tornado internal pressure coefficient

The external pressure coefficients (GC_p) are given in semi-log graphs and are a function of location on the building (wall or roof zones), roof slope, and effective wind area (see Section 26.2 of ASCE 7-22 for the definition of effective wind area). Like MWFRS, the process for selecting the external pressure coefficient to determine C&C pressures is the same for safe rooms as for normal-use buildings.

External pressure coefficient: The value of (GC_p) for C&C elements is related to the location on the building surface (wall or roof), roof slope, and the effective wind area of the element. Effective wind area is essentially the area tributary to a particular element. However, the width of the tributary area need not be less than $1/3$ the length (or span) of the area. Using this effective width provides a better approximation of the actual load distribution for elements with long and narrow tributary areas. It is not uncommon for the effective wind area of a C&C element to be different from the tributary area for the same element (see Figure B3-4). The effective wind area is used to select the external pressure coefficient for calculating the design wind pressure. The tributary area is still the area over which the calculated wind pressure is applied for that specific C&C-designed element. For cladding fasteners, ASCE 7 requires that the effective wind area not be greater than the area that is tributary to an individual fastener.

The external pressure coefficient is constant and maximum magnitude for effective wind areas less than 10 square feet in most cases (20 and 100 square feet apply to limited cases) and (in most cases) constant and minimum magnitude for effective wind areas greater than 100, 200, 300, or 500 square feet, depending on the building surface and the height of the building. If the tributary area of a component element exceeds 700 square feet, the design wind pressure acting on that component may be based on the MWFRS provisions.

Once the appropriate MWFRS and C&C wind or tornado pressures are calculated for the safe room, they should be applied to the exterior wall and roof surfaces of the safe room to determine design wind and tornado loads for the MWFRS and C&C elements of the safe room. After these wind and tornado loads are identified, the designer should determine the relevant load combinations for the safe room (refer to B3.2.3).

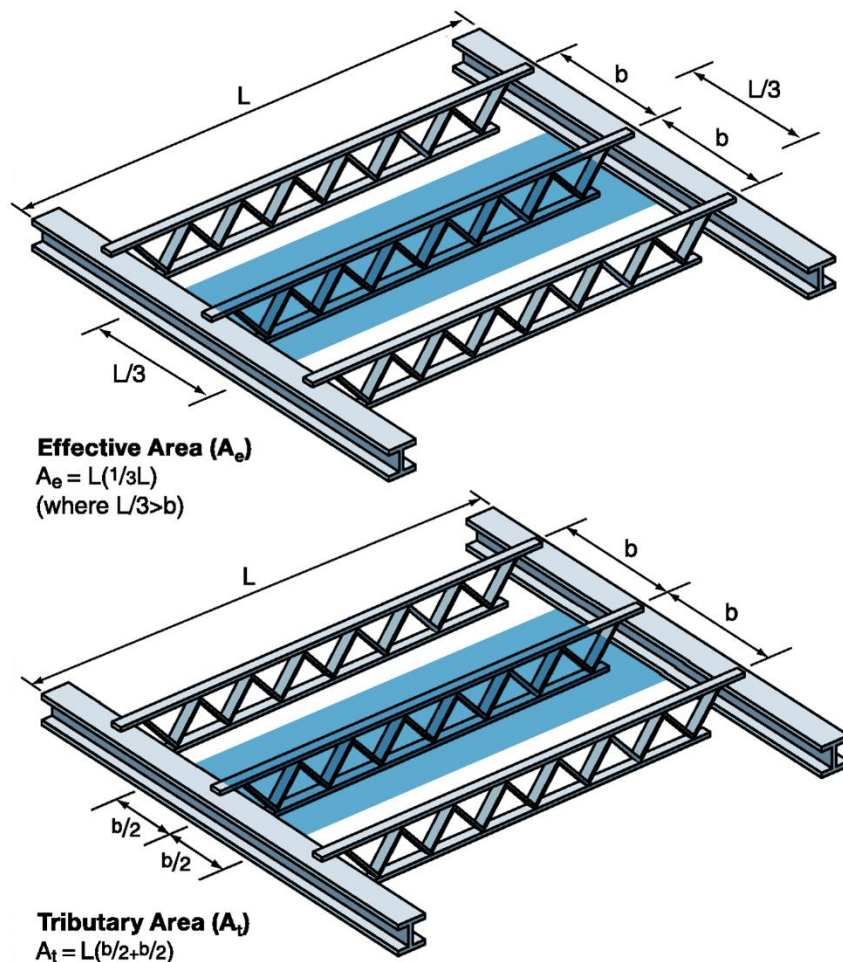

Figure B3-4: Comparison of tributary and effective wind areas for a roof supported by open-web steel joists

B3.2.5.2.3 Combination of MWFRS and C&C Loads

According to ASCE 7, the MWFRS is an assemblage of structural elements assigned to provide support and stability for the overall structure and transfer wind loads acting on the entire structure to the ground. The MWFRS generally carries wind or tornado loads from more than one surface of the building. Elements of the building envelope that do not qualify as part of the MWFRS are identified as C&C. Some elements are considered part of both C&C and MWFRS, depending on the wind or tornado load and direction being considered. For example, load bearing exterior walls may transmit MWFRS wind uplift forces from the roof, and/or shear forces from a roof diaphragm/adjacent walls as axial and in-plane shear forces, respectively, in addition to simultaneously receiving C&C wind loads directly, which result in out-of-plane shear and bending in the wall.

Consider the exterior reinforced masonry wall shown in Figure B3-5. For wind direction 1, (WIND 1) some of the lateral loads from the windward wall can be transferred through the side wall as in-plane

shear (depending on design of the lateral load resisting system) and calculated using MWFRS provisions; axial loads from the roof are also calculated using MWFRS provisions. Out-of-plane loads from wind suction acting directly on the masonry side wall are calculated using C&C provisions. For wind direction 2 (WIND 2), out-of-plane loads from wind acting directly on the masonry wall are calculated using C&C provisions and axial loads from the roof are calculated using MWFRS provisions.

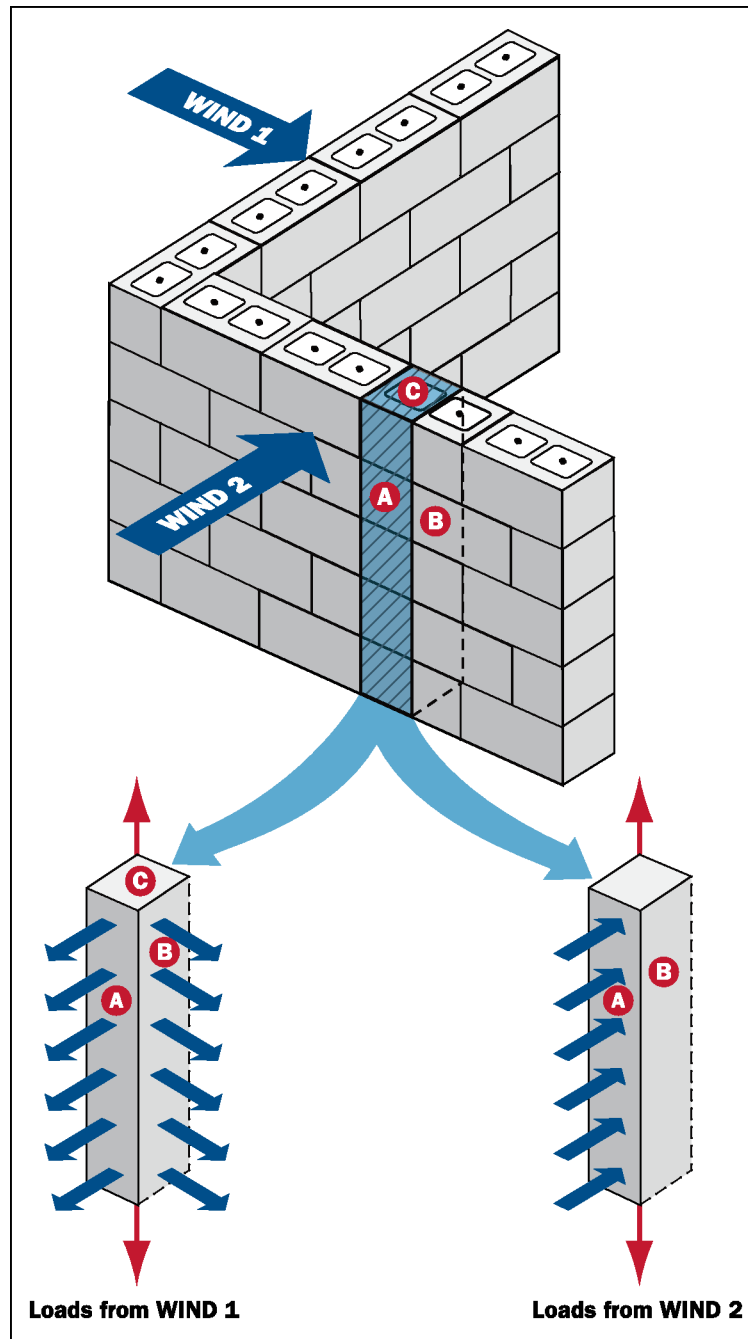

Figure B3-5: MWFRS combined loads and C&C loads acting on a safe room wall section

B3.2.5.3 Continuous Load Path Concepts

Structural systems that provide a continuous load path are those that support all loads acting on a building, laterally and vertically (inward and outward, upward and downward). Many buildings have structural systems capable of providing a continuous load path for gravity (downward) loads, but do not provide a continuous load path for the lateral and uplift forces generated by tornadic and hurricane winds; such buildings commonly experience significant damage or collapse in extreme winds.

A continuous load path can be thought of as a “chain” running through a building. The “links” of the chain are structural members, connections between members, and any fasteners used in the connections (e.g., nails, screws, bolts, welds, reinforcing steel). To be effective, each “link” in the continuous load path must be strong enough to transfer loads without permanently deforming or breaking. Because all applied loads (e.g., gravity, dead, live, uplift, lateral) must be transferred into the ground, the load path must continue unbroken from where the load originates on the building envelope through the foundation and into the ground.

In general, the continuous load path that carries wind or tornado forces acting on a building’s exterior starts with cladding elements such as wall cladding, roof covering and decks, and windows or doors. These items are classified as C&C in ASCE 7 (the roof deck would be classified as a MWFRS when designed as a horizontal diaphragm). Uplift loads on the roof surface transfer to the supporting roof deck or sheathing and then to the roof structure made up of rafters, joists, beams, trusses, and girders. The structural members and elements of the roof must be adequately connected to each other and to the walls or columns that support them, which must be continuous and connected properly to the foundation, which, in turn, must be capable of transferring the loads to the ground.

Figure B3-6 illustrates connections important to continuous load paths in masonry, concrete, or steel-frame buildings. Figure B3-6 also demonstrates the lateral and uplift wind or tornado forces that act on the structural members and connections. Figure B3-7 illustrates a continuous load path for uplift forces (only) in a typical commercial building. A deficiency in any of the connections depicted in these figures may lead to structural damage or collapse.

In a tornado or hurricane safe room, this continuous load path is essential for the safe room to resist wind forces. The designers of safe rooms should be careful to ensure that all connections along the load path have been checked for adequate capacity.

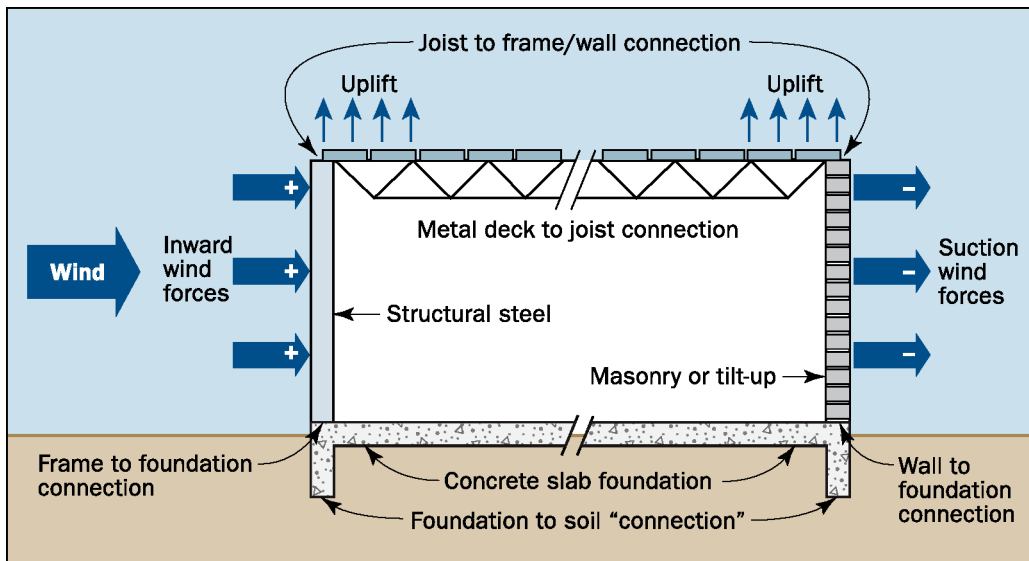

Figure B3-6: Critical connections important for providing a continuous load path in a typical masonry, concrete, or metal-frame building wall (for clarity, concrete roof deck is not shown)

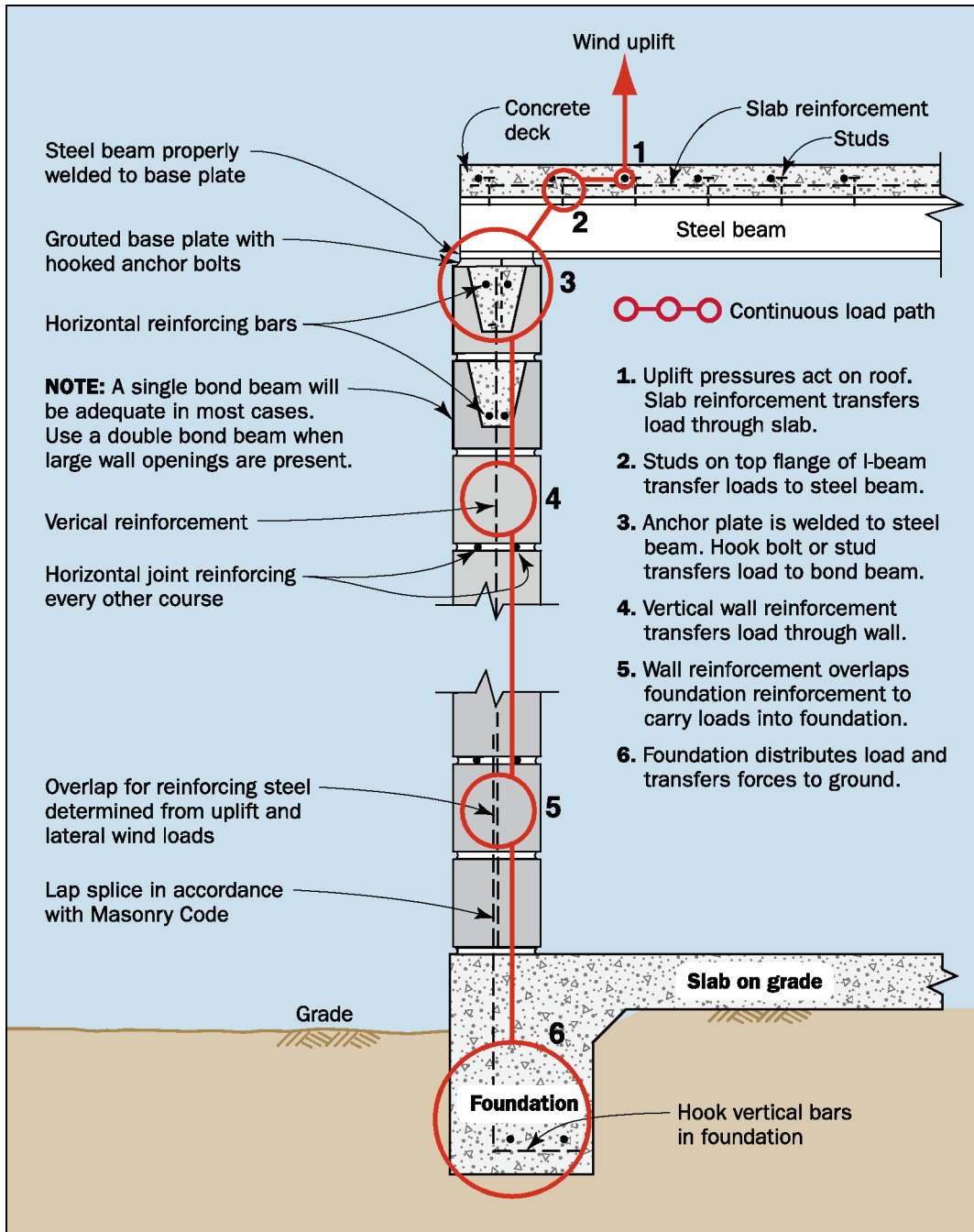

Figure B3-7: Continuous load path in a reinforced masonry building with a concrete roof deck

B3.2.5.3.1 Roof Connections and Roof-to-Wall Connections

Adequate connections must be provided between the roof sheathing and roof structural support, steel joists, and other structural roofing members and walls or structural columns. These are the connections at the top of the continuous load path and are required to keep the roof system attached to the safe room.

Reinforcing steel, bolts, steel studs, welds, and screws may be used to connect roof decking of a safe room to supporting members. The size and number of these connections required for a safe room depend on the wind pressures that act on the roof systems.

Figure B3-8 shows damage to a school in Oklahoma that was struck by a tornado. The school used a combination of construction types: steel frame with masonry infill walls and load-bearing unreinforced masonry walls. Both structural systems supported open-web steel joists with a lightweight roof system composed of light steel decking, insulation, and a built-up roof covering with aggregate ballast.

Figure B3-8 highlights a connection failure between a bond beam and its supporting unreinforced masonry wall, as well as the separation of the open-web steel joists from the bond beam. See Figure B3-7 for an illustration of connections in a reinforced masonry wall that are likely to resist forces from a tornado or hurricane. Note that four connection points—between the roof decking and joists, the joist and the bond beam, the bond beam and the wall, and the wall to the foundation—are critical to a sound continuous load path.



SOURCE: FEMA 342

Figure B3-8: Failure of load path between the bond beam and the top of the unreinforced masonry wall when struck by an F4 tornado (Moore, Oklahoma 1999 tornado)

B3.2.5.3.2 Foundation-to-Wall Connections (Reference: ICC 500 Sec 307)

Anchor bolts, reinforcing steel, embedded plate systems properly welded together, and nailed or screwed mechanical fasteners for wood construction are typical connection methods for establishing a load path from foundation systems into wall systems. These connections are the last connections in the load path that transfer the forces acting on the building into the foundation and, ultimately, into the ground. The designer should check the ability of both the connector and the material into which the connector is anchored to withstand the design uplift and shear forces.

CODES AND STANDARDS

Sections 111.1.2 (item 3) and 111.1.2.1 of ICC 500 require a special inspection to be performed when safe room anchors are post-installed in hardened concrete and masonry. The special inspection is intended to verify the anchor installation and capacity, as well as the foundation adequacy. This requirement can be bypassed on residential safe rooms only if the authority having jurisdiction verifies that the foundation and anchoring comply with the requirements of the safe room or storm shelter design.

Figure B3-9 shows two columns from a building that collapsed when it was struck by the vortex of a weak tornado. Numerous failures at the connection between the columns and the foundation were observed. Anchor bolt failures were observed to be either ductile material failures or, when ductile failure did not occur, embedment failures.

The adequacy of the foundation to resist or transfer all applicable loads is of equal importance as the adequacy of the anchors that transfer the loads to it. Foundations of safe rooms, including both new and existing slabs-on-grade, are required to be designed for the applicable loads in accordance with Section 307 of ICC 500.

There are some exceptions for very heavy (concrete or masonry concrete) residential or small (64 square feet or less) community safe rooms that can be installed on existing slabs-on-grade without a foundation (refer to ICC 500 Section 307.3). This is only allowed if the dead load of the safe room is heavy enough to resist sliding and global overturning from the safe room design wind pressures. In these cases, the slab thickness and reinforcement should be verified as sufficient to support the weight of the safe room.



SOURCE: FEMA P-908

Figure B3-9: Bolt failure at interior column resulting from shear and tension. The hooked anchor bolts pulled out of the slab (red arrow) (Joplin, Missouri 2011 tornado)

B3.2.6 DEBRIS HAZARDS (REFERENCE: ICC 500 SEC 305)

The elements of the safe room structure and its components (including windows, doors, and all other impact-protective systems) that separate the individuals therein from the event outside should resist failure from wind or tornado pressures and debris impacts.

Wind-borne debris protection levels for storm shelters and safe rooms in ICC 500 are much more stringent than the levels in the IBC, IRC, and ASCE 7. FEMA Funding Criteria include more restrictive guidance than ICC 500 for residential safe rooms because all residential safe rooms must meet the 250 mph design criteria. All building elements that make up the portion of the safe room that protects the occupants should resist impacts from wind-borne debris. No portion of the envelope (roof, wall, baffled entry, door, window, etc.) should fail due to wind or tornado pressure or be breached by the specified missile (at the appropriate debris impact wind speed). The only exceptions are roof or wall coverings that perform according to code for non-safe room design features (e.g., non-structural cladding for tornado safe room for normal weather protection) but are sacrificial and not needed to protect the safe room occupants during an extreme wind event. In addition, openings for ventilation into and out of the safe room should be hardened or protected to resist both missile impact and pressure testing criteria.

NOTE**Safe Room Door Assemblies**

For more information and guidance on finding and installing residential tornado safe room door assemblies, please see FEMA's *Residential Tornado Safe Room Doors* Fact Sheet (2024d). *FEMA's Community Tornado Safe Room Doors: Installation and Maintenance* Fact Sheet (2024a) provides information about the selection, installation, and maintenance of safe room door assemblies for community safe rooms. Both fact sheets are available for download at <https://www.fema.gov/emergency-managers/risk-management/building-science/safe-rooms/resources>.

If the safe room is located within a building where the applicable code already requires glazing protection for the building envelope (e.g., Wind-Borne Debris Region), the code-mandated requirements must still be met for the host building, but the envelope of the safe room within the host building must meet the requirements of this section. A more detailed discussion of the debris impact criteria is provided in Chapter B8 of this publication.

B3.2.6.1 Test Missile Criteria for Community Tornado Safe Rooms (Reference: ICC 500 Sec 305.1.1)

The test missile for community tornado safe rooms is required to be a 15-pound 2x4 (dimension lumber) member. The speed of the test missile impacting vertical envelope surfaces varies from 100 mph to 80 mph, and the speed of the test missile impacting horizontal surfaces varies from 67 mph down to 53 mph. Table B3-3 presents the missile impact speeds for the different tornado speeds applicable for tornado safe room designs.

Table B3-3: Tornado Missile Impact Criteria

Safe Room Design Tornado Speed	Missile Speed and Safe Room Impact Surface
250 mph	Vertical Surfaces: 100 mph / Horizontal Surfaces: 67 mph
200 mph	Vertical Surfaces: 90 mph / Horizontal Surfaces: 60 mph
160 mph	Vertical Surfaces: 84 mph / Horizontal Surfaces: 56 mph
130 mph	Vertical Surfaces: 80 mph / Horizontal Surfaces: 53 mph

Note: Walls, doors, and other safe room envelope surfaces inclined 30 degrees or more from the horizontal should be considered vertical surfaces. Surfaces inclined less than 30 degrees from the horizontal should be treated as horizontal surfaces.

B3.2.6.2 Test Missile Criteria for Community Hurricane Safe Rooms (Reference: ICC 500 Sec 305.1.2)

The test missile for community hurricane safe rooms is required to be a 9-pound 2x4 (dimension lumber) member. The speed of the test missile impacting vertical safe room surfaces should be a

minimum of 0.50 times the safe room design wind speed. The speed of the test missile impacting horizontal surfaces should be 0.10 times the safe room design wind speed.

Table B3-4 presents the missile impact speeds for the different wind speeds applicable for hurricane safe room designs.

Table B3-4: Hurricane Missile Impact Criteria

Safe Room Design Wind Speed	Missile Speed (of 9-pound 2x4 board member) and Safe Room Impact Surface
235 mph	Vertical Surfaces: 118 mph / Horizontal Surfaces: 24 mph
230 mph	Vertical Surfaces: 115 mph / Horizontal Surfaces: 23 mph
220 mph	Vertical Surfaces: 110 mph / Horizontal Surfaces: 22 mph
210 mph	Vertical Surfaces: 105 mph / Horizontal Surfaces: 21 mph
200 mph	Vertical Surfaces: 100 mph / Horizontal Surfaces: 20 mph
190 mph	Vertical Surfaces: 95 mph / Horizontal Surfaces: 19 mph
180 mph	Vertical Surfaces: 90 mph / Horizontal Surfaces: 18 mph
170 mph	Vertical Surfaces: 85 mph / Horizontal Surfaces: 17 mph
160 mph	Vertical Surfaces: 80 mph / Horizontal Surfaces: 16 mph

Note: Walls, doors, and other safe room envelope surfaces inclined 30 degrees or more from the horizontal should be considered vertical surfaces. Surfaces inclined less than 30 degrees from the horizontal should be treated as horizontal surfaces.

B3.2.6.3 Test Missile Criteria for Residential Safe Rooms

For FEMA-funded residential safe rooms, the impact test missile is required to be a 15-pound 2x4 (dimensional lumber) member. The speeds of the test missile impacting vertical and horizontal surfaces of FEMA-funded residential safe rooms are presented in Table B3-5. As indicated in Section B3.1, the required test missile speeds for FEMA-funded residential safe rooms differ from the minimum requirements in ICC 500, which allow residential storm shelters and storm shelter components to meet the impact criteria required for the storm shelter storm type and design wind speed where it is to be constructed or installed.

Table B3-5: Residential FEMA-Funded Safe Room Test Missile Impact Criteria

Safe Room Design Wind Speed	Test Missile Speed (of 15-pound 2x4 board member) and Safe Room Impact Surface
250 mph	Vertical Surfaces: 100 mph / Horizontal Surfaces: 67 mph

Note: Walls, doors, and other safe room envelope surfaces inclined 30 degrees or more from the horizontal should be considered vertical surfaces. Surfaces inclined less than 30 degrees from the horizontal should be treated as horizontal surfaces.

B3.2.6.4 Soil Cover as Protection from Debris Impact

Soil cover on or around safe rooms can help protect the safe room from debris impact. Debris impact resistance may not be required for portions of safe rooms that are below ground or covered by soil (Figure B3-10). Safe rooms with at least 12 inches of vertical soil cover protecting horizontal surfaces and with at least 36 inches of horizontal soil cover (sloped not greater than 2:12) protecting vertical surfaces do not need to be tested for resistance to missile impact because the surfaces are not exposed. Soil in place around the safe room as specified above provides suitable protection from the representative tornado safe room test missile. Figure B3-11 (based on ICC 500 Figure 305.2.2) presents this information graphically.

The referenced soil cover provisions assume the soil is compactable fill.



SOURCE: FEMA 342

Figure B3-10: View of a community shelter that is partially below grade (Wichita, Kansas, 1999 tornado)

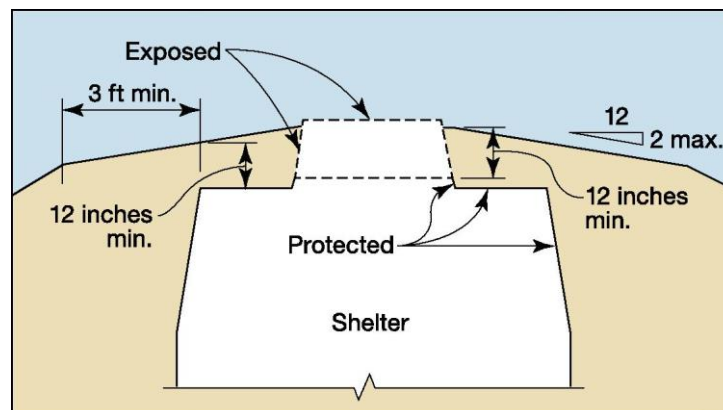

Figure B3-11: Soil cover over a safe room relieving the requirement for debris impact resistance

B3.2.6.5 Laydown, Falling Debris, and Rollover Hazards (Reference: ICC 500 Sec 305.3)

Following the design criteria for the wind speed selected from Figure B3-1 and Figure B3-2 and the representative test missile impact criteria outlined in Sections B3.2.6.1, B3.2.6.2, and B3.2.6.3 will produce safe room designs with roof and wall assemblies capable of withstanding impacts from wind-borne debris. Prior to ICC 500-2020, laydown, rollover, and collapse hazards were classified as “other debris hazards” under Section 305.3, which provided that each be “considered by the design professional when determining the location of the shelter on the site.” Because FEMA provided no additional funding criteria for “other hazards,” the standard criteria governed both storm shelters and safe rooms. In the 2020 edition of ICC 500, specific criteria were added to 1) determine whether the identified risk is close enough to the safe room to require analysis and 2) quantify the minimum loading.

Design professionals are required to quantify the loading from laydown and falling debris hazards (see definitions in the textbox below, which include examples of both hazards) where the safe room is within the radius of the laydown hazard (i.e., height of the hazard is greater than distance between the hazard and safe room) and fall radius of the falling debris as illustrated in Figure B3-12. Quantifying the impact load of either must include a minimum impact factor of 2.0 times the weight of the identified hazard. Where multiple impact loads have been determined, they may be considered one at a time, but each should be applied to the roof of the safe room simultaneously with all other applicable uniform live loads.

TERMINOLOGY

Lay down hazard (ICC 500): Adjacent building elements, other structures and natural objects that could fall onto the roof of a storm shelter, such as exterior walls of adjacent single-story structures, self-supporting towers, poles, or large trees. (see Figure B3-13 and Figure B3-14).

Falling debris hazard (ICC 500): Exterior components, cladding, and appurtenances, such as parapet walls, masonry cladding, or rooftop equipment, that could fall onto the roof of a storm shelter from wind damage to adjacent, taller buildings or taller sections of a host building. (see Figure B3-15).

Rollover hazard: Vehicles and small buildings, such as portable classrooms or storage buildings, which can roll or tumble and impact a safe room (see Figure B3-16).

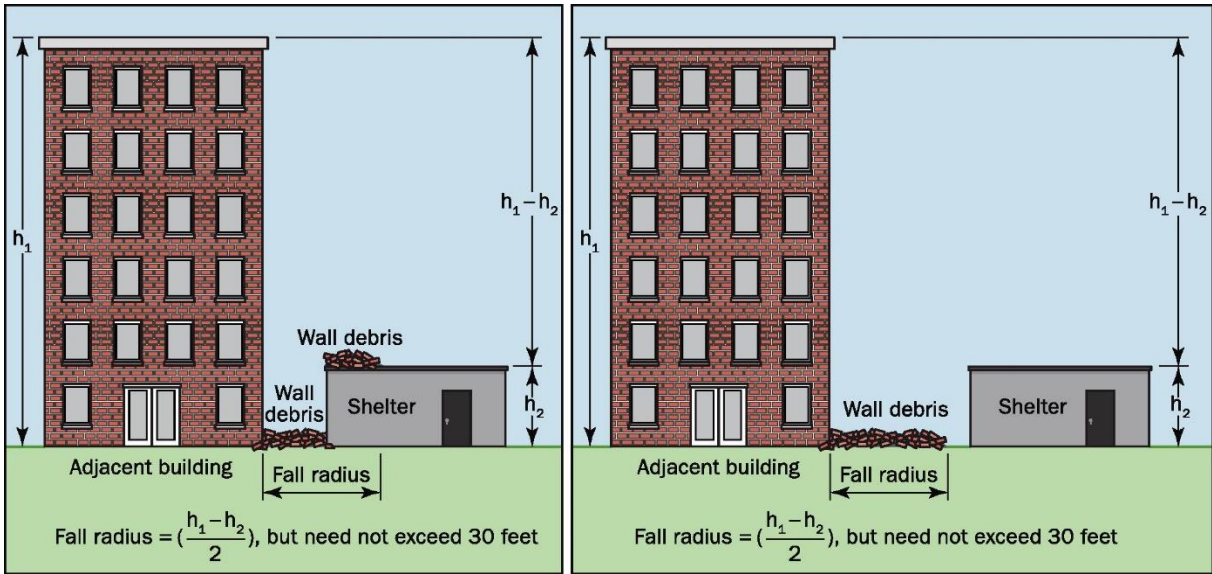

Figure B3-12: Falling debris fall radius. Left image shows example of where the safe room is sited within the falling debris hazard’s fall radius and impact loading is required. Right image shows where falling debris impact loading is not required.



SOURCE: FEMA P-2022

Figure B3-13: Laydown of communications tower onto a building (Rockport, Texas, 2017 hurricane)



SOURCE: FEMA P-908, RECOVERY ADVISORY 5

Figure B3-14: Laydown of a large communications tower onto a building (Joplin, Missouri, 2011 tornado)

Falling debris testing has been conducted in the past (Clemson University, 2000) to provide guidance on the residual capacity of safe room roof assemblies. The experiments subjected a variety of pre-cast and cast-in-place safe room roof assembly sections to impacts from deformable, semi-deformable, and non-deformable debris released from heights up to 100 feet and allowed to impact the roofs by free fall. The greatest damages were inflicted by non-deformable, 1,000-pound concrete barrels that were dropped from a height of 50 feet. The simulated falling debris hazard revealed the following performance characteristics and recommendations for the tested safe room roof assemblies:

- Roof designs that incorporate a uniform thickness (i.e., flat slab) provide a more uniform level of protection than other designs that incorporate a thin slab supported by secondary beams (e.g., ribbed slab).
- If the concrete is cast onto metal roof decking, the steel beams/decking should be connected to the concrete with shear connector studs to contain spalling concrete.



SOURCE: FEMA P-2022

Figure B3-15: Example of falling debris hazard: Brick veneer failure on church (Refugio, Texas, 2017 hurricane)

Rollover hazard includes vehicles and small buildings, such as portable classrooms or storage buildings, which can roll or tumble and impact a safe room. While FEMA still recommends that the rollover hazard be considered by safe room design professionals, observed building damage

resulting from a rollover hazard during tornadoes and hurricanes has not been as significant as laydown and falling debris hazards primarily because rollover hazards are typically traveling at lower velocities upon impact. Also, vehicles typically make up the most massive variety of rollover hazard (Figure B3-16) and they absorb much of the impact energy through deformability.

Lastly, because rollover hazards can be moved on and off any site, they are much more difficult to identify when designing the safe room.



Figure B3-16: Vehicle rollover (Greensburg, Kansas, 2007 tornado)

The location of the safe room can affect the type of debris that may impact or settle on top of it. Section B4.2.2.4 addresses safe room siting considerations related to nearby laydown and falling debris hazards.

B3.2.7 ENVELOPE COMPONENT TESTING, LISTING, AND LABELING (REFERENCE: ICC SEC 306)

To demonstrate that the safe room provides life-safety protection, all safe room components (e.g., impact-protective systems and wall, roof, door, and glazing assemblies) should successfully pass the component-specific testing requirements set forth in Section 306 of ICC 500. In addition to door and glazing assemblies that protect openings in safe room walls and roofs, openings created by service utility penetrations should be protected in accordance with Section 306.4.3 as described in the “FEMA Safe Room Helpline” textbox on the following page. Specifications and procedures for all safe room tests are provided in ICC 500, Chapter 8, “Test Methods for Impact and Pressure Testing.”

CODES AND STANDARDS

Community safe room testing criteria for missile impact resistance and for static and cyclic pressure are the same as the storm shelter testing criteria presented in ICC 500 Section 306 and Chapter 8, “Test Methods for Impact and Pressure Testing.”

Missile impact testing criteria for safe room components are described in Sections B3.2.6.1 (community tornado safe rooms), B3.2.6.2 (community hurricane safe rooms), and B3.2.6.3 (FEMA-funded residential safe rooms). FEMA guidance on this topic is presented in Chapter B8.

All impact-protective systems are required to be listed and labeled by an approved agency in accordance with ICC 500 Section 306.4.1 to denote compliance with the specified pressure and missile impact testing criteria. Labels should indicate the manufacturer's identification reference or listing number for the assembly, type of impact protective system, storm type, edition of ICC 500 with which testing complied, and performance characteristics, such as the test missile weight and speed, and design tornado pressure or design wind pressure (or both for combined tornado and hurricane safe rooms). Although ICC 500 requires impact-protective systems for openings to be labeled indicating compliance with the standard, there is no universal format for such labels. A representative example is shown in Figure B3-17. Note the label shown in this figure references the previous edition of ICC 500, which was published in 2020. Label marking requirements in the current edition of ICC 500 include the same basic information, except that new products installed in FEMA-funded safe rooms or storm shelters in locations where ICC 500-2023 is adopted should reference the 2023 edition of ICC 500. Although most labels also reference FEMA P-361, Chapter B8 of this publication references ICC 500 for all safe room testing procedures.

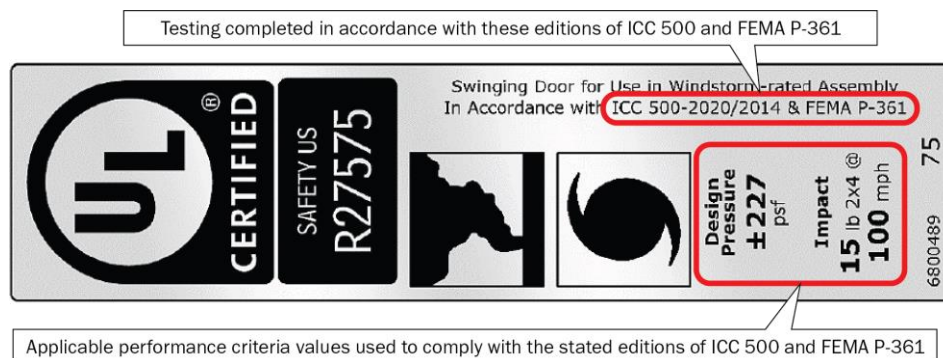

Figure B3-17: Example door label for a product that has been tested to earlier safe room criteria

FEMA is not a product testing agency and does not “certify” or lend their authority to any group to produce or provide “FEMA-approved” or “FEMA-certified” products. The means by which product testing and compliance with the FEMA criteria is documented and presented is addressed in Chapter B1.

FEMA supports Section 306.1 of ICC 500, which states that no additional impact testing is required if the most stringent criteria of missile size and speed are met for the largest and smallest available sizes of impact-protective systems. Further, ICC 500 Section 306.4 provides that if field anchorage of the tested impact-protective system differs from the type tested (e.g. different wall/roof substrate or anchor type), then the RDP can design alternate anchorage capable of resisting the pull-out and shear for the storm shelter design wind or tornado loads.

More information and guidance on safe room testing criteria is presented in Chapter B8.

EXAMPLE**FEMA Safe Room Helpline Guidance on Utility Service Penetrations**

Inquiry: I am a designer working on plans for new residential construction and my client wants a safe room based on the FEMA P-320 design drawings in their home. We've decided to make a bathroom with closet as that space. My questions are as follows:

- I don't want to depend on natural ventilation for normal use of the space, so what are the requirements for HVAC?
- What are the requirements for the plumbing vent pipes and electrical supply?

Response: The criteria for storm shelter envelope penetrations may be found in ICC 500, Section 306.4.3: "Penetrations of storm shelter envelope by mechanical, electrical and plumbing systems." Since FEMA P-361 does not recommend any additional criteria for safe room penetration protection beyond ICC 500 (reference Table B3-1), the standard criteria govern both storm shelters and safe rooms.

ICC 500 Section 306.4.3 requires impact-protective devices for penetrations that exceed 3.5 square inches in area for rectangular openings or 2.5 inches in diameter for circular openings. The safe room designs in FEMA P-320 rely on natural ventilation to avoid larger mechanical vent openings which require custom-sized impact-protective devices (e.g., steel shields and cowlings) to protect the interior of the safe room from wind-borne debris. Unlike safe room door assemblies, custom-sized shields and cowlings are not commercially available (at present) and need to be designed to be anchored to the surrounding wall or roof system by structural engineers who specialize in safe room design. Lastly, if your safe room mechanical ventilation system requires support systems located outside of the safe room envelope (e.g., AC unit or air handler) to meet ICC 500 minimum ventilation requirements, then those systems must be protected to the same wind pressure and missile impact requirements of Chapter 3 (as well as flood-resistance requirements of Chapter 4 if located in a flood hazard area).

Please note that plumbing and electrical penetrations in the safe room envelope are treated the same as the mechanical penetrations described above.

Alcove or Baffled Entry Systems

In lieu of specifying door assemblies that meet the safe room test missile criteria, an alcove or baffled entry system can be designed to meet ICC 500 criteria. FEMA provides no additional criteria for alcove and baffled entry systems, so the standard criteria govern both storm shelters and safe rooms. ICC 500 Section 803.9.7 provides three types of alcove and baffled entry system configurations with corresponding storm shelter door assembly requirements as follows:

1. The missile impacts at least twice on barriers (ICC 500-compliant wall or roof assemblies) prior to entering the storm shelter or safe room protected area as shown in Figure B3-18. For this configuration, no door assembly is required but the boundary between the protected and

unprotected occupant area must be clearly marked on the floor and wall area inside the entrance.

2. The missile impacts at least one barrier (ICC 500-compliant wall or roof assemblies) prior to impacting the storm shelter or safe room door assembly. While the required door assembly must meet test pressure requirements specified in Section 306 and Chapter 8 for this configuration, impact testing may be conducted with a 9-pound 2x4 missile traveling at 34 mph.
3. The missile can impact the door without striking a barrier (ICC 500-compliant wall assemblies) first but cannot impact it perpendicularly. The minimum door assembly criteria for configuration 2 apply to configuration 3.

Terminology

Alcove or Baffled Entry System: An entry system that uses walls and passageways to allow access to and egress from the protected occupant area while providing shielding from wind-borne debris.

The alcove or baffled entry system described in configuration 1 above can simplify or possibly even eliminate the need to lock down the safe room, which can facilitate the admission of late-arriving occupants. Although the wind pressures at the primary safe room door should be reduced by the presence of the alcove, there has not been much research to quantify the reduction. **BEST PRACTICE:** *Although not required by ICC 500 for configuration 1, installing a primary safe room door tested to resist the safe room design wind pressure to better protect occupants from the effects of small flying debris.*

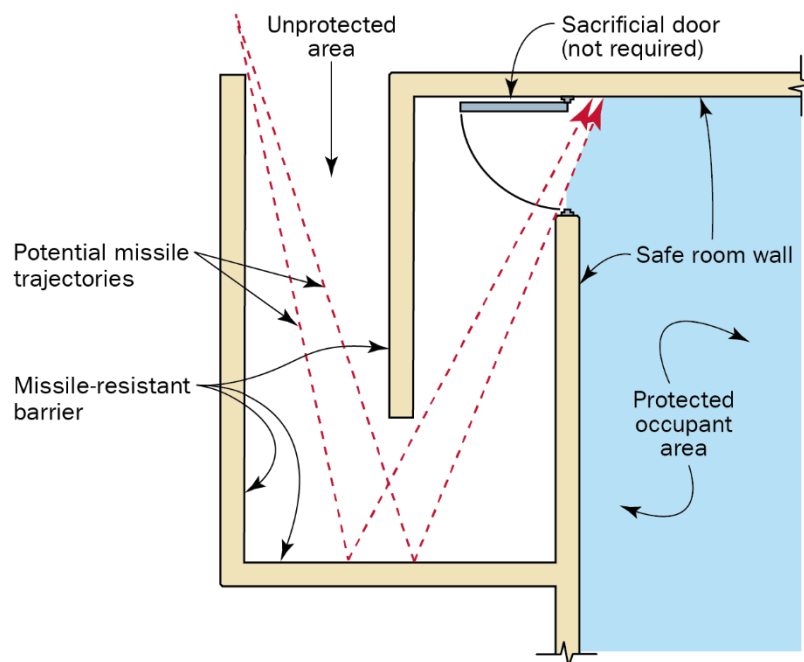

Figure B3-18: Alcove entry system protected by a debris-resistant barrier (note that the safe room roof extends past the safe room wall and connects to the top of the debris-resistant barrier to prevent intrusion of debris traveling vertically)

Chapter B4 Siting

This chapter uses Chapter 4 of ICC 500 as the referenced standard and includes a list of FEMA Funding Criteria that FEMA has identified as more conservative than the provisions in Chapter 4 of ICC 500. This chapter also includes FEMA additional guidance on siting based on many years of field observations and investigations related to safe room performance.

FEMA Safe Room Grant Requirements

Whenever a safe room is constructed using FEMA grant funds, the FEMA Funding Criteria shown in Section B4.1 become requirements in addition to the requirements of ICC 500 Chapter 4.

B4.1 Criteria

The siting of safe rooms should be conducted in accordance with the provisions of Chapter 4 in ICC 500 as amended by FEMA's Funding Criteria as shown in Table B4-1.

For safe rooms being constructed with FEMA grant funds, the listed amendments become mandatory minimum requirements in addition to the corresponding ICC 500 criteria. FEMA grant programs have specific flood hazard siting limitations as described in Section B4.2.3. Additionally, the planning and design of community safe rooms funded with FEMA grants should be conducted according to the process mandated by 44 CFR Chapter 1, Subchapter A, Part 9, "Floodplain management and protection of wetlands." Refer to Section B4.2.2 for additional discussion on FEMA siting requirements.

Table B4-1: Comparison of ICC 500 Requirements to FEMA Funding Criteria

ICC 500 Reference	ICC 500 Requirement ^(a)	FEMA Funding Criteria ^(b)
Table 402.1 Storm Shelters Required to Comply with Section 402	<p>Location of Storm Shelter: 500-year flood hazard area</p> <p>Type of Shelter: Community tornado shelter</p> <p>ICC 500: Risk Category IV facilities or serving Risk Category IV facilities</p>	<p>Location of Safe Room: 500-year flood hazard area</p> <p>Type of Safe Room: Community tornado safe room</p> <p>FEMA: All</p>
Section 402.5 Storm Shelter Siting	<p>Storm shelters shall be located outside of the following high-risk areas:</p> <ol style="list-style-type: none"> Coastal high-hazard areas and coastal A zones. Floodways <p>Exception: Storm shelters shall be permitted in coastal high-hazard</p>	<p>Safe rooms shall be located outside of the following high-risk flood hazard areas:</p> <ol style="list-style-type: none"> Coastal high-hazard areas and coastal A zones. Floodways For residential safe rooms, any areas subject to storm surge

ICC 500 Reference	ICC 500 Requirement ^(a)	FEMA Funding Criteria ^(b)
	<p>areas and coastal A zones where permitted by the Board of Appeals in accordance with the provisions of the International Building Code or the International Residential Code.</p>	<p>inundation, including coastal wave effects, associated with the maximum intensity hurricane modeled using the National Hurricane Center's <i>Sea, Lake and Overland Surges from Hurricanes (SLOSH)</i> for the location where the residential hurricane safe room is to be sited.</p> <p>Exception: Safe rooms may be permitted in <i>coastal high-hazard areas</i> and <i>coastal A zones</i> where permitted by the Board of Appeals in accordance with the provisions of the <i>International Building Code</i> or the <i>International Residential Code</i> and approved by FEMA. Community safe rooms proposed to be sited in SFHAs or the 500-year flood hazard area require successful completion of the 8-step Decision Process for Executive Order (EO) 11988, as amended, and as Provided by Title 44 of the Code of Federal Regulations Part 9.6, Decision Making Process.^(c)</p>
<p>Section 402.6.1 Minimum floor elevation of community tornado shelters</p>	<p>The lowest floor used for the <i>occupied storm shelter areas</i> and <i>occupant support areas</i> of a <i>community tornado shelter</i> shall be elevated to or above the highest of the elevations determined by all of the following:</p> <ol style="list-style-type: none"> 1. The minimum elevation of the lowest floor required by the <i>authority having jurisdiction</i>. 2. One foot (305 mm) above the <i>base flood elevation</i>. 3. For <i>storm shelters</i> that are Risk Category IV facilities or serving Risk Category IV facilities: <ol style="list-style-type: none"> 3.1. The 500-year flood elevation. 3.2. Two feet (610 mm) above the <i>base flood elevation</i>. 	<p>The lowest floor used for the <i>occupied safe room areas</i> and <i>occupant support areas</i> of a <i>community tornado safe room</i> shall be elevated to or above the highest of the elevations determined by all of the following:</p> <ol style="list-style-type: none"> 1. The minimum elevation of the lowest floor required by the <i>authority having jurisdiction</i>. 2. Deleted 3. The 500-year flood elevation. 4. Three feet (915 mm) above the base flood elevation. <p>No Exceptions apply</p>

ICC 500 Reference	ICC 500 Requirement ^(a)	FEMA Funding Criteria ^(b)
	<p>Exceptions:</p> <ol style="list-style-type: none"> 1. A <i>community tornado shelter</i> is not required to be elevated to the level required by Items 1 through 3 where all of the following are met: <ol style="list-style-type: none"> 1.1. The <i>storm shelter</i> is completely within a host building that is dry floodproofed in accordance ASCE 24 to the elevation prescribed in Items 1 through 3; or the <i>storm shelter</i> is dry floodproofed in accordance with ASCE 24 to the elevation prescribed in Items 1 through 3. 1.2. The <i>storm shelter</i> has at least one door, emergency escape opening or hatch complying with Chapter 5 that has the bottom of the opening located above the dry floodproofing elevation. 1.3. The elevation of the floor of the <i>storm shelter</i> is not more than 36 inches below the elevation required by Items 1 through 3. 2. Where a <i>community tornado shelter</i> is constructed within an existing host building, only item 1 shall apply. 	
Section 402.6.3 Minimum floor elevation of residential tornado shelters	<p>The lowest floor of a <i>residential tornado shelter</i> shall be elevated to or above the highest of the elevations determined by all of the following:</p> <ol style="list-style-type: none"> 1. The minimum elevation of the lowest floor required by the <i>authority having jurisdiction</i>. 2. One foot (305 mm) above the <i>base flood elevation</i>. <p>Exception: Where a <i>residential tornado shelter</i> is constructed within an existing <i>host building</i>, only Item 1 shall apply.</p>	<p>The lowest floor of a <i>residential tornado safe room</i> shall be elevated to or above the highest of the elevations determined by all of the following:</p> <ol style="list-style-type: none"> 1. The minimum elevation of the lowest floor required by the <i>authority having jurisdiction</i>. 2. Two feet (610 mm) above the <i>base flood elevation</i>. <p>No Exceptions apply.</p>

ICC 500 Reference	ICC 500 Requirement ^(a)	FEMA Funding Criteria ^(b)
Section 402.6.2 Minimum floor elevation of community hurricane shelters	<p>The lowest floor used for the occupied storm shelter areas and occupant support areas of a community tornado shelter shall be elevated to or above the highest of the elevations determined by all of the following:</p> <ol style="list-style-type: none"> 1. The minimum elevation of the lowest floor required by the <i>authority having jurisdiction</i>. 2. Two feet (610 mm) above the <i>base flood elevation</i>. 3. The 500-year flood elevation. 4. The storm surge elevation 	<p>The lowest floor used for the occupied safe room areas and occupant support areas of a community tornado safe room shall be elevated to or above the highest of the elevations determined by all of the following:</p> <ol style="list-style-type: none"> 1. The minimum elevation of the lowest floor required by the <i>authority having jurisdiction</i>. 2. Three feet (915 mm) above the base flood elevation. 3. The 500-year flood elevation. 4. The storm surge elevation
Section 402.6.4 Minimum floor elevation of residential hurricane shelters	<p>The lowest floor of a residential hurricane shelter shall be elevated to the highest of the elevations determined by all of the following:</p> <ol style="list-style-type: none"> 1. The minimum elevation of the lowest floor required by the <i>authority having jurisdiction</i>. 2. The 500-year flood elevation. 3. The <i>storm surge elevation</i>, including coastal wave effects. 	<p>The lowest floor of a residential hurricane safe room shall be elevated to the higher of the elevations determined by all of the following:</p> <ol style="list-style-type: none"> 1. The minimum elevation of the lowest floor required by the <i>authority having jurisdiction</i>. 2. The 500-year flood elevation. 3. Not applicable.^(d) 4. Two feet (610 mm) above the base flood elevation.

Bolded text denotes differences between the ICC 500 Requirement and the FEMA Funding Criteria.

Notes:

(a) ICC 500 language reprinted here with permission from the International Code Council.

(b) Table only lists requirements where there are differences between FEMA P-361 and ICC 500 Chapter 4. All ICC 500 Chapter 4 requirements not listed in the table should also be met in their entirety. Safe room types (e.g., community, residential, tornado, hurricane) outside the scope of any given FEMA Funding Criterion need only meet the corresponding ICC 500 criteria (where applicable).

(c) The FEMA Funding Criteria for the ICC 500 flood siting exception apply to all FEMA-funded safe rooms seeking a flood siting exception to ICC 500 Section 402.5.

(d) Corresponding ICC 500 requirement is not applicable because residential safe rooms should not be located in areas subject to storm surge inundation associated with the maximum intensity hurricane.

B4.2 FEMA Additional Guidance

FEMA offers the following background information and guidance for the criteria referenced in ICC 500 Chapter 4 or presented as FEMA Funding Criteria in Section B4.1.

B4.2.1 FEMA FUNDING CRITERIA: SITING

FEMA Funding Criteria for safe room siting are more restrictive than those for storm shelters in ICC 500 so that safe rooms are available to provide near-absolute protection when needed during or after flood events. Designers should consider that the lowest safe room floor elevations specified in Section B4.1 are minimum requirements and improved performance in flood-prone areas can be achieved by further increasing the safe room floor elevation (i.e., adding more freeboard).

Starting with the 2020 edition, ICC 500 has reduced the minimum floor elevation criteria for community tornado storm shelters unless they are classified as Risk Category IV facilities (i.e., designated for post-storm recovery functions) or serve Risk Category IV facilities. FEMA has maintained the minimum floor elevation criteria from previous editions of the standard and FEMA P-361. Executive Orders 13690 and 14030 require the inclusion of the Federal Flood Risk Management Standard (FFRMS) into FEMA-funded grant projects. FFRMS requires all FEMA-funded community tornado safe rooms that are sited in the flood hazard areas described in Table B4-1 to be elevated to the 500-year flood elevation (i.e., the flood elevation having a 0.2 percent annual chance of being equaled or exceeded in any given year) or 3 feet above the base flood elevation (BFE), whichever is higher. The additional freeboard criteria help to offset the potential of a flood exceeding the minimum floor elevation. As indicated in ASCE 24, freeboard addresses uncertainty in the flood modeling, watershed development, sea level changes, changes in precipitation patterns, and other factors. Benefits of additional freeboard include decreased potential for floodwater entering the safe room at any time, which will result in greater reliability and reduced repair and maintenance costs for the community as described in greater detail below.

NOTE

Design Flood vs. Actual Flood

FEMA MATs commonly observe flooding that exceeds the minimum floor elevation requirements for community tornado storm shelters and safe rooms. For example, flood elevations at 10 of the 17 non-residential buildings in Chapter 3, “Flood-Related Observations,” of the Hurricane Harvey MAT Report exceeded either 2 feet above the BFE or the 500-year flood elevation. All sites were outside of Category 5 storm surge inundation areas in Harris County, which is threatened by both tornadoes and hurricanes.

ICC 500 also includes two exceptions to the minimum lowest floor elevation criteria for community tornado storm shelters. The first exception applies conditionally to storm shelters that have been dry floodproofed in accordance with ASCE 24 or are sited within host buildings that have been dry floodproofed in accordance with ASCE 24. The second exception applies to storm shelters installed in existing buildings. As noted in Table B4-1, neither elevation exception is permitted for FEMA-funded safe rooms.

FEMA Funding Criteria eliminate the first elevation exception for tornado safe rooms based on concerns over the existing standard-based allowances for dry floodproofing and observed

performance of dry floodproofing systems. The dry floodproofing requirements outlined in ASCE 24 were devised for property protection rather than life-safety protection. Accordingly, requirements were developed to minimize the chance of floodwaters reaching lower levels of buildings with the understanding that if a flood protection measure was overtopped, protected areas would quickly fill with water. But as observed on numerous FEMA MATs, dry floodproofing measures often fail prior to overtopping as a result of improper design, poor maintenance, and/or inadequate installation. Failure for any reason that occurs before a storm shelter is needed could jeopardize the availability of the storm shelter; failure during sheltering could threaten the safety of the occupants.

The intent of the second community tornado storm shelter elevation exception is to provide affordable tornado protection options by allowing construction or retrofit of storm shelters in existing buildings without requiring the storm shelter to be elevated in accordance with requirements for new or Substantially Improved buildings.⁶ However, unlike the conditions applied to the exception for storm shelters installed in dry floodproofed buildings, there is no limit to how low the storm shelter floor can be set in existing buildings. Subgrade areas of older buildings in flood-prone areas are particularly vulnerable to recurring inundation and subsequent flood damage, which typically require repairs (e.g., removal of flood-damaged finishes, mold remediation). While under repair, the storm shelter may be closed or operating at reduced capacity, leaving intended occupants unprotected from tornadoes. Similarly, ASCE 24 does not require interior building areas protected by dry floodproofing to be constructed with flood damage-resistant materials. So, either exception will result in storm shelters that are much more vulnerable to the effects of inundation and subsequent closure. Although flooding damage can occur for safe rooms that comply with FEMA Funding Criteria, the likelihood is significantly less.

NOTE

FFRMS Application to Safe Rooms

The minimum elevation requirements for FFRMS are different for critical actions and non-critical actions. Part 9.4 of 44 CFR Chapter 1 Subchapter A defines the types of development that are considered critical actions—use these definitions (see <https://www.ecfr.gov/current/title-44/chapter-I/subchapter-A/part-9>) to identify whether the project is considered a critical action. If a project is not considered a critical action, then it is deemed a non-critical action. It is likely that a community safe room would be considered a critical action and, thus, must meet the minimum elevation requirements for a critical action. It is unlikely that a residential safe room would be considered a critical action and, thus, a residential safe room would only need to meet the requirements for a non-critical action.

⁶ If the alteration of the existing building to add the storm shelter triggers a Substantial Improvement determination, then the elevation exception should be voided by the authority having jurisdiction.

- **Critical Action Minimum Elevation Requirements:** The higher of BFE+3 feet or the 500-year flood elevation. These requirements apply to development within the SFHA and the 500-year floodplain where delineated.
- **Non-critical Action Minimum Elevation Requirements:** The lower of BFE+2 feet or the 500-year flood elevation. Where no 500-year flood elevation is provided BFE+2 feet is the minimum elevation requirement. In areas where the flood source is coastal, the requirement is the lower of BFE+2 feet or the 500-year stillwater flood elevation. These requirements apply to development within the SFHA.

FEMA safe room requirements can exceed the FFRMS elevation and floodplain extent requirements. An example of this is that the residential hurricane and combined safe rooms must meet the minimum elevation requirements if they are located within the 500-year floodplain.

B4.2.2 GENERAL SITING CONSIDERATIONS

Safe rooms by their very function are exceptionally dependent on their location for their effectiveness. Safe rooms must be located as close as possible to their potential users, specifically the population at risk from extreme-wind hazards.

In addition, the location of a safe room is determined by other considerations, such as safety, accessibility, and a variety of environmental and siting factors. This section examines the most important factors that should be considered when siting a safe room. Refer also to Chapter A4, which describes safe room operational considerations, some of which may affect siting decisions.

B4.2.2.1 Function and Use

Community safe rooms may be designed and constructed to serve a single property or facility, such as a school, hospital campus, or a manufactured housing park, or to serve multiple properties, such as those in a neighborhood. Conversely, residential safe rooms serve only occupants in dwelling units and may be sited anywhere on a non-flood-hazard-restricted property (e.g., inside of a home, in a backyard, garage) as long as the door is located within a 150-foot travel path from an exterior door of the dwelling unit (if located outside).

The site selection criteria that pertain to the functionality of a safe room are closely associated with the risk and vulnerability assessment criteria described in Chapter A2. Risk and vulnerability considerations that must be considered include:

- The size and geographic distribution of the at-risk population
- The vulnerability of the at-risk population with respect to the buildings they normally occupy
- The vulnerability of the at-risk population with respect to their ability to reach the safe room in a timely manner during an emergency

Maximum Population and Allowable Travel Time

Prospective safe room owners, operators, planners, and designers should follow HMA guidance and work with their FEMA state or Regional grant personnel for the policy on safe room population and maximum allowable travel time/distance to safe rooms.

Additionally, the site selected might need to accommodate people occupying public facilities, such as hospitals, residential care facilities, schools, and childcare centers, that house large populations; such populations may not be able to reach a remote safe room quickly enough during an emergency. Typically, this type of facility is served by safe rooms inside the building or attached to it, minimizing evacuation challenges.

In multi-building or campus situations where a safe room serves other buildings in addition to the building housing the safe room, having enclosed or underground walkways from the served buildings to the safe room is desirable, as there may be strong winds, heavy rain, or hail preceding the arrival of the tornado. If these solutions are not feasible, covered walkways should be considered.

B4.2.2.2 Multi-Hazard Site Considerations

The safety of a site is evaluated on the basis of its exposure to multiple hazards. Sites exposed to flooding need to be carefully evaluated for safe rooms, not only because of the dangers flooding may pose for the occupants, but also because flooding can isolate the facility and its occupants or make it inaccessible in an emergency. Other hazards that should be considered are seismic, landslides, and fires (especially the exposure of the site to wildfire). Chapter A2 provides information on assessing risk of hazards.

B4.2.2.3 Access

The accessibility of a site is directly related to the anticipated safe room service area and its proximity to the potential occupants. Potential users should be able to reach the safe room within the required time period using a designated pedestrian pathway. Unobstructed access is an important element of safe room design. The pathway to a safe room should not have restrictions or obstructions, such as multi-lane highways, railroad tracks, bridges, or similar facilities or topographic features. See also Section B4.2.2.5 and Section B4.2.2.6 for maximum allowable travel time/distance.

CROSS-REFERENCE

Refer also to Section A4.5 for additional information on access and entry.

If obstructions exist along the travel route, or if the safe room is cluttered with non-essential equipment and storage items, orderly access to the safe room will be impeded. Hindering access in any way can lead to unnecessary increased travel time, chaos, or panic.

Building/Site-Related Access Issues

Siting factors that affect access should be considered. For example, vehicle parking at a community safe room built to serve a residential neighborhood should not impede access to the safe room; at a workplace safe room, such as a manufacturing facility, equipment, parts handling, and product storage should not impede safe room access.

The location of a safe room on a building site is an important consideration of the design process for any safe room. The safe room should be located such that all persons designated to take refuge can reach the safe room quickly; this is of particular importance for tornado safe rooms. Safe rooms located at one end of a building or one end of a community, office complex, or school may be difficult for users at the other end to reach in a timely fashion. Routes to the safe room should be easily accessible and well-marked. For more information on signage considerations in community safe rooms, see Section A4.3.2 and Section B5.2.8.

Flood-Related Access Issues

Safe rooms located where mapped flood depths are 3 feet and higher may become isolated if access routes are flooded. As a result, emergency services would be delayed or unavailable if safe room occupants should need assistance after the storm. ***BEST PRACTICE: Safe rooms in flood-prone areas should be properly equipped to meet reasonably anticipated emergency medical, food, and sanitation needs during the time the occupants could be isolated by flooding.***

Terminology

The requirements and best practices in Chapter B4, “Siting,” use the terms “SFHA” and “base flood.”

Special Flood Hazard Area (SFHA): The land area covered by the floodwaters of the flood having a 1% chance of being equaled or exceeded in any given year. This area is typically mapped on FEMA’s Flood Insurance Rate Maps (FIRMs) as Zone A or Zone V.

Base Flood: The flood having a 1% chance of being equaled or exceeded in any given year. It may also be referred to as the “100-year flood.”

Access to the safe room should be maintained during flooding conditions, if possible. If access is not possible by ground transportation during flooding, alternative access should be provided. An example of how alternative access can be achieved is the installation of a helicopter landing pad that is above the safe room design flood level, or a loading dock or other area of the building could be used as a dock for small boats if the area is inundated. In all cases, both the designer and owner will need to work with local and state emergency managers to ensure that any alternative access methods are properly planned, both in the safe room design and construction and in emergency operation procedures. For more information on siting in relation to flood hazards, see Section B4.2.2.

B4.2.2.4 Siting Proximity to Laydown and Falling Debris Hazards

Whenever possible, safe rooms should be located away from laydown and falling debris hazards. Laydown hazards can include walls of adjacent single-story buildings, natural objects (e.g., massive trees), and tall structures such as light towers, antennas, and water towers that can topple onto safe rooms during tornadoes or hurricanes. Similarly, parapets, brick veneer, and large roof-mounted mechanical equipment from taller, adjacent buildings can become falling debris that impact and damage the safe room.

Impact loading criteria for laydown and falling debris hazards, including minimum siting distances (or radii) that trigger their application, are now addressed in ICC 500 as described in Section B3.2.6.5.

B4.2.2.5 Siting Proximity to Occupants for Residential Safe Rooms (Reference: ICC 500 Sec 403.1)

There are a number of potential locations to construct a safe room inside of a home. Though tornado warnings are often issued with enough time for someone in one room of a home to travel to a safe room in another area of the home, mobility and ease of safe room ingress should be considered for all safe rooms.

A residential safe room can also be located outside of the home. To enter such a safe room, occupants will need to travel to the safe room from the home. ICC 500 requires that the access opening for a residential safe room be located such that the distance of the travel path is no more than 150 feet from an exterior door of the residence. Whenever possible, occupants should access exterior safe rooms prior to the onset of high winds to prevent injuries from wind-borne debris as they travel to the safe room.

B4.2.2.6 Siting Proximity to Occupants for Community Safe Rooms (Reference: ICC 500 Sec 403.2)

Safe room designers should consider the time needed for all occupants of a building or facility to reach the safe room. The NWS has made great strides in predicting tornadoes and hurricanes and providing warnings that allow more time to seek shelter.

Travel time requirements for tornado safe rooms

For tornadoes, the time span is often short between the NWS warning and the onset of the tornado. In accordance with *HMA Program and Policy Guide*, FEMA requires that tornado safe rooms be sited so that occupants have a maximum walking travel time of 5 minutes or a maximum driving travel distance of approximately $\frac{1}{2}$ mile to reach the safe room. The actual travel route or pathway—whether driven or walked—should not be restricted, bottlenecked, or obstructed by barriers such as multi-lane highways, railroad tracks, bridges, or similar facilities or by topographic features. When determining driving travel time, potential traffic congestion (including parking constraints) that may occur when potential at-risk occupants are moving to the safe room after a storm watch/warning notification has been issued should be considered. Additionally, the walking speed of occupants going to the safe room on foot should be considered. Using a 3 mph walking speed, a 5-minute travel time corresponds to approximately $\frac{1}{4}$ mile (1,320 feet). Where intended safe room occupants are

coming from nearby buildings (e.g., school or hospital campuses with multiple buildings), a maximum distance of 1,000 feet between the occupant-source building's egress and the safe room entrance is recommended to allow time for egressing the occupant-source buildings. A 1,000-foot maximum distance from not fewer than one exterior door of each building to a door of the shelter serving that building may be required by building code for newly constructed safe rooms in some areas. Refer to Section B1.2.2 for guidance on complying with the building code and *HMA Program and Policy Guide* where tornado safe rooms are funded by FEMA to serve occupants coming from nearby buildings.

Travel Time Requirements for Hurricane Safe Rooms

For hurricane safe rooms, a different set of criteria applies. Because there is usually a substantial amount of warning time for hurricanes, and because mandatory evacuations may be issued, the criteria to determine travel time for a hurricane safe room can be more complex.

Those not able to evacuate for a hurricane (first responders, critical and essential services personnel, and certain medical or residential care facility occupants) would be the potential population for a hurricane safe room where vehicular access to the U.S. mainland is available. See Chapters A2 and A4 for more information on considerations for the population traveling to the safe room.

Travel Time Considerations for Those with Impaired Mobility

Travel time may be especially important when safe room users are elderly or have disabilities that impair their mobility and may need assistance from others to reach the safe room. In addition, wheelchair users may need a particular route that accommodates wheelchairs. The designer should consider these factors to provide the shortest possible access time and most accessible route for anticipated safe room occupants.

B4.2.2.7 Manmade Siting Hazards

It is important that the designer consider other hazards at the building site, in addition to the wind, flood, wildfire, landslide, and seismic hazards already mentioned.

One such consideration is the presence of a hazardous material on a site. Older buildings that are retrofitted for safe room use should be inspected for hazardous materials that may be stored near the safe room (e.g., gasoline, chlorine, other chemicals) or that may have been used in the construction of the surrounding building (e.g., lead paint, asbestos). For example, asbestos may become airborne if portions of the surrounding building are damaged, resulting in the chemical contamination of breathable air. Live power lines, smoke, fire, hazardous fumes, and gas leaks are also safe room design concerns that may need to be addressed at some safe room sites.

B4.2.2.8 Other Factors to Consider

Other factors may also need to be considered, including environmental and historic preservation, economic, zoning, or other administrative factors. These factors should be considered from the very start of the design process.

B4.2.3 FLOOD HAZARDS (REFERENCE: ICC 500 SEC 402)

Flood hazards should be considered when designing and constructing a safe room. Designers should investigate all sources of flooding that could affect the use of the safe room. The functionality of a safe room can be affected by flooding in many different ways. Flooding can inundate a structure housing a safe room and can also affect the safe room by disrupting or blocking access when surrounding areas flood. Safe rooms in flood-prone areas are also susceptible to damage from hydrostatic and hydrodynamic forces associated with rising floodwater and from debris carried in the water. But non-structural flood damages resulting from inundation are more likely, potentially disrupting availability for intended occupants as described in Section B4.2.1. Most importantly, flooding of occupied safe rooms can result in injuries or deaths (see adjacent “Tornadoes and Flash Flooding” textbox). Areas with high groundwater tables should also be considered cautiously when considering installation or construction of in-ground safe rooms, as buoyancy forces can potentially push the structure out of the ground as described in Section B3.2.4.4.

WARNING

Tornadoes and Flash Flooding

Safe room site flood history is especially important for areas subject to flash flooding as described in the following excerpt from an American Meteorological Society (AMS) research article on concurrent and collocated tornado and flash flood (TORFF) events (Nielsen et al., 2015):

There are numerous historical examples of the impacts that TORFF events can have on society. On 31 May 2013, a TORFF event in Oklahoma City, Oklahoma, tragically illustrated examples of the additional complexities in warning dissemination and risk perception in a multi-threat, collocated event, which further magnified the danger beyond the meteorological hazard alone. Thirteen deaths were associated from the flash flooding whereas eight deaths were directly associated with the tornado. Perhaps most alarming, members of the public interviewed seemed to have no knowledge of the flash flooding threat despite warnings in place and social media dissemination (NWS, 2014). More recently, a woman drowned in Oklahoma in May 2015 while seeking refuge from a tornado in a storm shelter [sic] (KWTU, 2015).*

Areas subject to flash flooding include areas with steep slopes, narrow stream valleys, and developed areas with large impervious surfaces. Such areas can concentrate runoff quickly, often leading to deep, high-velocity flow. In some cases, warnings of the potential for flash flooding are issued by the National Weather Service, local news outlets, and local emergency management offices.

When siting safe rooms, designers should consult with local emergency managers (city/county) in order to identify and understand areas at risk of flash floods.

* The excerpt mistakenly uses the term storm shelter; the woman actually sought refuge in a below-ground storm cellar (ME’s Office, 2015).

B4.2.3.1 General Flood Hazard Siting/Elevation

This section outlines general flood-related siting and elevation criteria for safe rooms. If the chosen safe room site is located outside of the mapped floodplain(s) or storm surge inundation area that dictates the lowest floor elevation for the type of safe room proposed (reference Table B4-1), then the designer should include a statement in the design drawings documenting that the site is outside the corresponding flood-prone area(s). ***BEST PRACTICE: For areas outside of the mapped floodplain(s) or storm surge inundation area, the best practice is to evaluate the site's flood history (including flood of record elevations where available) and the latest Flood Insurance Study (FIS) when determining and specifying the elevation of the lowest safe room floor.*** Project submittal documents for hurricane storm shelters and safe rooms are also required to include the site's rainfall intensity (see Section B3.2.4.1) and the hurricane storm surge elevation associated with the maximum intensity hurricane modeled using the National Hurricane Center's Sea, Lake and Overland Surges from Hurricanes (SLOSH) (or other approved source) data for the location (see Section B9.1).

Location of Safe Room within a Floodplain

Safe rooms should not be sited in SFHAs unless consultation with local and state emergency management officials concludes there is no other feasible option. If it is not possible to locate a safe room outside of the SFHA, precautions should be taken to ensure the safety and well-being of anyone using the safe room. The lowest floor of the safe room and safe room occupant support areas is required to be elevated to or above the flood elevation specified in Table B4-1 (Section B4.2.1 provides guidance on differences between ICC 500 and FEMA for minimum siting and elevation requirements). All exterior utilities or services supplied to the safe room should be protected from flooding as well. Additionally, the planning and design of a FEMA-funded safe room should be conducted according to the process mandated by 44 CFR Part 9, Floodplain management and protection of wetlands and FFRMS.

NOTE

Flood of Record Criteria

Previous editions of FEMA P-361 and ICC 500 included the following conditional criterion for determining the minimum elevation for the lowest floor of any safe room or storm shelter: "The flood elevation corresponding to the highest recorded flood elevation if a flood hazard study has not been conducted for the area."

Since ICC 500-2020 and FEMA P-361 (2021), the conditional lowest floor criterion has been replaced with Section 402.3, *Determining flood elevation and floodways*. The current updated requirements correlate with provisions in 2024 IBC (Section 1612.3.1, Design Flood Elevations) on how to determine flood elevations and floodways when not included in the flood hazard map or flood elevation study. In addition to providing consistency with the model code, the updated approach is more reliable than the "highest flood of record" method, which is easily misapplied since two areas in relatively close proximity might have different sources of flooding.

As shown in Table B4-1, FEMA Funding Criteria require all community tornado safe rooms to elevate to the 500-year flood elevation or 3 feet above the BFE, whichever is higher. Residential tornado safe rooms are required to elevate to the lower of the 500-year elevation or BFE plus 2 feet, whichever is lower. Community hurricane safe rooms and combined (hurricane and tornado) safe rooms are required to be elevated to the highest of the following: 500-year flood elevation, 3 feet above the BFE, or the elevation corresponding to the maximum storm surge inundation, including coastal wave effects, associated with the maximum intensity hurricane. Lastly, residential hurricane or combined safe rooms must be elevated to the 500-year flood elevation or 2 feet above the BFE, whichever is higher. The minimum elevation criteria for residential hurricane safe rooms also align with ICC 500 except that siting within the maximum storm surge inundation area is prohibited for FEMA-funded projects, so the corresponding storm surge elevation criterion does not apply.

BEST PRACTICE: Designers should consider implementing flood elevations that correspond with the best available data. For example, where preliminary FIRMs are issued but not yet adopted by the community, check to see if the planned safe room site has been added to the floodplain, or if already in the floodplain, whether the flood elevations have increased.

In many flood hazard areas around the country, the FIS and accompanying FIRMs may not specify flood elevations. This type of unspecified area is commonly referred to as unnumbered Zone A or approximate Zone A. In such cases, the flood elevation requirements for the base flood or 500-year flood elevations are not defined by FEMA. ICC 500 Section 402.3 now includes minimum requirements for determining flood elevations and floodway where the data are not included in the flood hazard map or where a flood elevation study has not been adopted. The following FEMA guidance on determining flood information that is consistent with the new requirements in ICC 500.

The base and 500-year flood elevations should be either determined by consulting local, state, or federal agencies, or calculated. The following may be sources of information on flood elevations:

- **Local floodplain administrator**
- **State National Flood Insurance Program (NFIP) Coordinator:** Some states have regulations or guidance on how to obtain regulatory data and some have repositories of data or may help conduct a new study.
- **Local flood control, sanitary, or watershed districts:** Like state agencies, these districts may have their own programs for developing new flood data.
- **U.S. Army Corps of Engineers (USACE), U.S. Department of Agriculture/Natural Resources Conservation Service, or U.S. Geological Survey (USGS):** These agencies may have knowledge of flood studies, unpublished reports, or other data that may pertain to the area in question.

More Information

Information on flood elevations associated with the base flood or 500-year flood can usually be found on FEMA's Map Service Center website (www.msc.fema.gov). The FIRMs on the website show the flood zone and associated elevation, if applicable and available.

For information on storm surge, contact the state or local emergency management offices.

Additional sources for flood information include:

Floodplain managers (see list at www.floods.org)

- Local building or zoning department
- USGS (including gauge data)
- NOAA
- NWS
- State Sea Grant Extension Programs
- USACE
- State or county highway department

Designers should also consider whether studies may have been performed for a nearby area. For instance:

- If a body of water forms a boundary between two communities, the community on the other side may have a detailed study; such base flood data are valid for both sides of a body of water.
- If the property is along a stream that is near state highway structures, such as bridges or culverts, the state highway department may have done a flood study to properly size the structure.
- If the property is on a river with a power-generating dam, the dam owner may have had to conduct a study for federal licensing.

If the required flood elevation information is not available, the local authority may be able to provide the requirements for determining the flood elevations in accordance with accepted engineering practices. Refer to the textbox on the following page for an example of how elevation data were determined for a proposed safe room site where BFEs were not published on the FIRM and the 500-year floodplain was undetermined.

EXAMPLE**Determining Flood Elevation Data Where Unmapped**

A proposed tornado safe room project is being planned in Greenville, MO. The safe room will be an addition to an existing building, with a normal-use function of educational classroom space. The existing building is located adjacent to a small stream. The safe room will be located outside the SFHA, approximately 80 feet from an approximate Zone A, with a portion of the existing building being located in the Zone A. An engineering analysis has already been completed to determine the elevation associated with the base flood; the analysis included the use of a regression equation for hydrology, the Hydrologic Engineering Center's River Analysis System (HEC-RAS) software for the hydraulics, and a 10-meter digital elevation model (DEM) from the USGS. Because this was a basic analysis, field surveys were not completed, and hydraulic structures were not included in the model. Channel geometry was determined from the DEM. The vertical accuracy of the DEM is ± 10 feet, or one-half the interval between contours on the USGS topographic map.

The BFEs are not published on the FIRM, though the water surface elevation used to determine the SFHA is included in the hydraulic model. The floodplain for the 500-year flood was not determined, nor was the water surface elevation for the 500-year flood calculated (Item #2).

Per safe room flood criteria in this publication as shown in the portion of Table B4-1 in this textbox, the lowest floor of the community safe room is the highest of the listed elevations.

In this example, the community floodplain management ordinance requires 1 foot of freeboard above the BFE. Therefore, item #1 was less than item #3. Based on information from the hydraulic model, the BFE was approximately 426.5 feet, so the minimum flood elevation for item #3 (3 feet above the BFE) is 429.5 feet. The proposed finished floor elevation of the safe room was 430.00 feet. Because the proposed safe room floor elevation is greater than the BFE+ 3 feet, item #3 is satisfied.

**Portion of Table B4-1 Relevant to Example
FEMA Funding Criteria for Safe Rooms**

The lowest floor used for the *occupied safe room areas and occupant support areas of a community tornado safe room* shall be elevated to or above the highest of the elevations determined by all of the following:

1. The minimum elevation of the lowest floor required by the *authority having jurisdiction*.
(BFE + 1 foot = 426.5 feet + 1 foot = 427.5 feet)
2. The *500-year flood elevation*. (429 feet)
3. Three feet (915 mm) above the *base flood elevation*.
(BFE + 3 feet = 426.5 feet + 3 feet = 429.5 feet)

429.5 feet is the highest elevation of the three criteria and is the minimum lowest floor elevation for the proposed tornado safe room.

The project team also had to compare the finished floor elevation to the 500-year flood elevation. This was particularly important in this instance because the safe room location was so close to a flood source. Using the hydraulic model, a regression equation was used to determine the discharge for the 500-year flood, and the water surface elevation was calculated as 429 feet. Therefore, item #2 was satisfied and the project was able to move forward using the proposed finished floor elevation of 430.00 feet.

In-ground Safe Rooms

In-ground safe rooms should not be installed in flood-prone areas unless the community has received a residential basement exception from FEMA.⁷ Areas with high groundwater tables should also be considered cautiously for in-ground safe rooms or safe rooms that are partially below grade, as buoyancy forces can potentially push the structure out of the ground. In-ground safe rooms and portions of safe rooms extending below-grade should be designed and installed to resist buoyant forces under saturated soil conditions as described in Section B3.2.4.4.

In-ground safe rooms should also be designed and sited to prevent water (due to rainfall and runoff, or in the case of residential basement exception communities, above-ground floodwater) from entering the entrance to the safe room or any other opening (refer to “Warning” textbox in Section B4.2.3). To this end, surfaces surrounding the in-ground safe room should be sloped away from the safe room entrance but not greater than 2 inches vertically across 3 feet of horizontal distance, which is the maximum slope permitted in ICC 500 in order for the soil to qualify for shielding the safe room from missile impacts. Sump pump systems may be used to help remove water from the safe room but will likely be ineffective where floodwaters are flowing above and across the entrance. If used to protect in-ground safe room occupants, these pump systems should be included in standby power considerations.

Tsunami

Tsunami hazards may be present in some jurisdictions where safe rooms are designed and constructed to provide protection from hurricanes. Although FIRMs are likely available for these areas, the FIRMs may not be based on tsunami hazards.

More Information

For additional information on the design and construction of structures in tsunami inundation areas, see FEMA P-646, *Guidelines for the Design of Structures for Vertical Evacuation from Tsunamis* (2019), available at <https://www.fema.gov/emergency-managers/risk-management/building-science/earthquakes>.

For additional information on the mapping of tsunami inundation zones, see the National Tsunami Hazard Mitigation Program website at <https://www.weather.gov/nthmp/>.

B4.2.3.2 Flood Design Criteria for Community Safe Rooms

A floodway is part of the SFHA and is the channel of a river or upstream flood elevation during the base flood. A community safe room in the floodway would not only be at risk of flooding but could

⁷ This exception has been granted in a small number of communities to allow in-ground tornado safe rooms to be constructed below the BFE.

become an obstruction causing an increase in flooding upstream. ICC 500 provides no appeals process for siting in the floodway.

Cross-Reference

Flood loads and conditions acting on a structure containing a safe room will be strongly influenced by the location of the structure relative to the flood source. See B3.2.3.2 for more information on flood load considerations.

The Coastal High-Hazard Area (Zone V) and Zone A areas seaward of the Limit of Moderate Wave Action (Coastal A Zone) are subject to damaging wave action, high-velocity flow, floating debris, erosion, and scour, making them generally unsuitable areas for safe rooms. Because of the increased hazard associated with these areas, community safe rooms are required to be located outside of Zone V and the Coastal A Zone unless they are permitted by the Board of Appeals in accordance with the provisions of the IBC and approved by FEMA through successful completion of the 8-step decision-making process. Community safe rooms proposed to be located in SFHAs or the 500-year flood hazard area are also required to complete the 8-step decision-making process as identified in 44 CFR Section 9.6 and described in the textbox below. This process would also need to be completed if the safe room would have any adverse effects on a wetland or increase the BFE.

NOTE

FEMA 8-Step Decision-Making Process

For the purpose of grant funding, the *HMA Program and Policy Guide* provides the criteria regarding floodplain management, including the 8-step decision-making process as identified in 44 CFR Section 9.6. As part of the 8-step decision-making process, FEMA must consider alternative locations to determine whether the floodplain or wetland is the only practicable location for that action. Applicants and subapplicants must document alternatives considered as part of their scoping process to assist FEMA in facilitating this decision-making process. If the floodplain or wetland is the only practicable location, the applicant/subapplicant must avoid or must minimize adverse impacts to the floodplain or wetland. For more information on this process, review the guidance provided in the *HMA Program and Policy Guide* or contact your State NFIP Coordinator or FEMA Regional office.

FEMA strongly recommends that communities only exercise the option to appeal for an exception to the safe room siting restrictions when no other options are available (e.g., safe room for the critical workforce of a pump station needed within a floodplain). ***BEST PRACTICE: The safe room's lowest floor elevation should be increased beyond the minimum requirements where a siting variance is granted because safe rooms would most likely have solid foundations in areas normally prohibited from closed foundations due to wave action.*** Solid foundations will result in significantly higher foundation loads than open foundations. Solid foundations will also experience wave runup when

waves hit the foundation wall, potentially requiring additional freeboard for any safe room entrance or point of water entry. Wave conditions and wave loads are discussed in FEMA P-55, *Coastal Construction Manual* (2011), Section 8.5.8.2. Wave action and high flood velocities could also prevent the evacuation of a safe room if higher than predicted flood levels are experienced.

Terminology

Storm surge: In this publication, the term storm surge means an abnormal rise in sea level accompanying a hurricane or other intense storm, and whose height is the difference between the observed level of the sea surface and the level that would have occurred in the absence of the cyclone. Storm surge (see figure below) is usually estimated by subtracting the normal or predicted astronomical tide from the observed storm tide. The measurement of storm surge does not include wave height unless specifically noted, which can add 3 feet or more. References to storm surge in this document refer to the maximum flood elevation associated with any modeled hurricane category, including coastal wave effects. See Chapter B9, “References and Resources,” for a list of some websites with state-specific storm surge inundation maps.

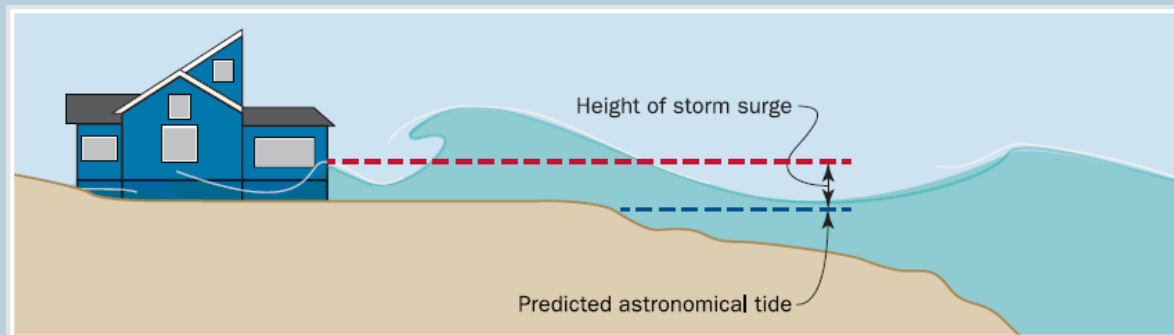

When at all possible, a community safe room should be located outside the influence of coastal storm surge and outside of any areas subject to flooding. Structures containing community safe rooms should be located in areas at low risk of flooding and mapped as unshaded Zone X or Zone C (outside the 500-year flood hazard area) wherever possible.

If siting the safe room outside the 500-year flood hazard area is not possible, the structure should be located in the least hazardous portion of the area subject to flooding during the 500-year flood (shaded Zone X or Zone B), or if that is not possible, then in the least hazardous portions of the base flood hazard area (i.e., within SFHA, Zones AO or AH, or Zones AE or A1–30). When a safe room is installed in an SFHA or other flood-prone area, the top of the lowest floor for the safe room, and its occupant support areas, should be elevated at or above the highest flood elevation defined in Table B4-1.

BEST PRACTICE: COASTAL FLOODING

As a best practice, designers should consider sea level rise where safe rooms may be exposed to coastal flooding. The recommended approach for determining the need for any additional elevation (freeboard) involves assessing the direct physical effects of potential relative sea level rise over the safe room's projected lifecycle (not less than 50 years). The minimum rate of potential relative sea level change may be found using NOAA's historical sea level change rates, currently located at <https://tidesandcurrents.noaa.gov/sltrends/>. Interpolation of the minimum rates is recommended where safe rooms sites are located between tide gauges.

Figure B4-1 shows mapped flood zones. Indicated on the figure are preferred, allowable, and restricted locations for community tornado and hurricane safe rooms with respect to mapped flood hazard zones. The yellow and green checkmark locations shown on the figure are acceptable assuming that safe room elevation requirements are met. Figure B4-2 shows an example of a shoreline-perpendicular transect, complementing Figure B4-1, to indicate which flood zone areas community safe rooms may be sited within.

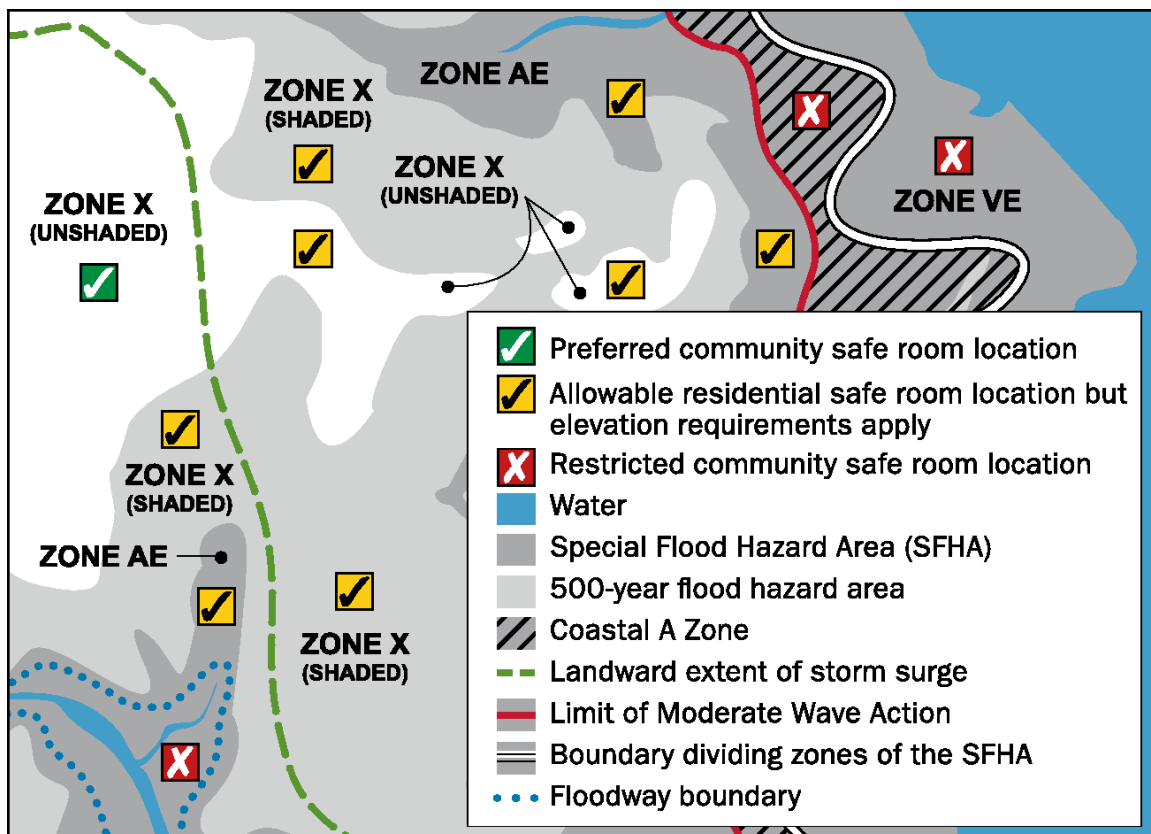

Figure B4-1: Example illustration of preferred, allowable, and restricted community safe room locations

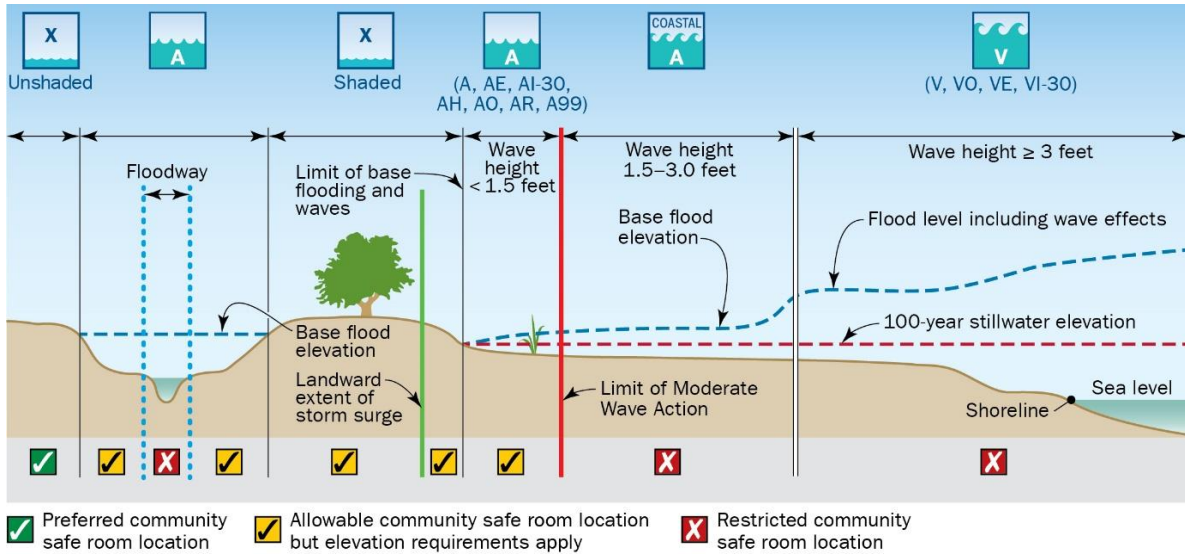

Figure B4-2: Example illustration of a typical riverine cross-section and perpendicular shoreline transect showing stillwater and wave crest elevations and associated flood zones for community safe room siting

Figure B4-3 illustrates a safe room elevated to meet all of the flood elevation criteria for community safe rooms. Figure B4-3 is an example, so the relative height of each elevation shown on the figure is not necessarily applicable to all locations. For instance, the BFE + 3 feet may not always be higher than the 500-year flood elevation or the minimum elevation required by the authority having jurisdiction.

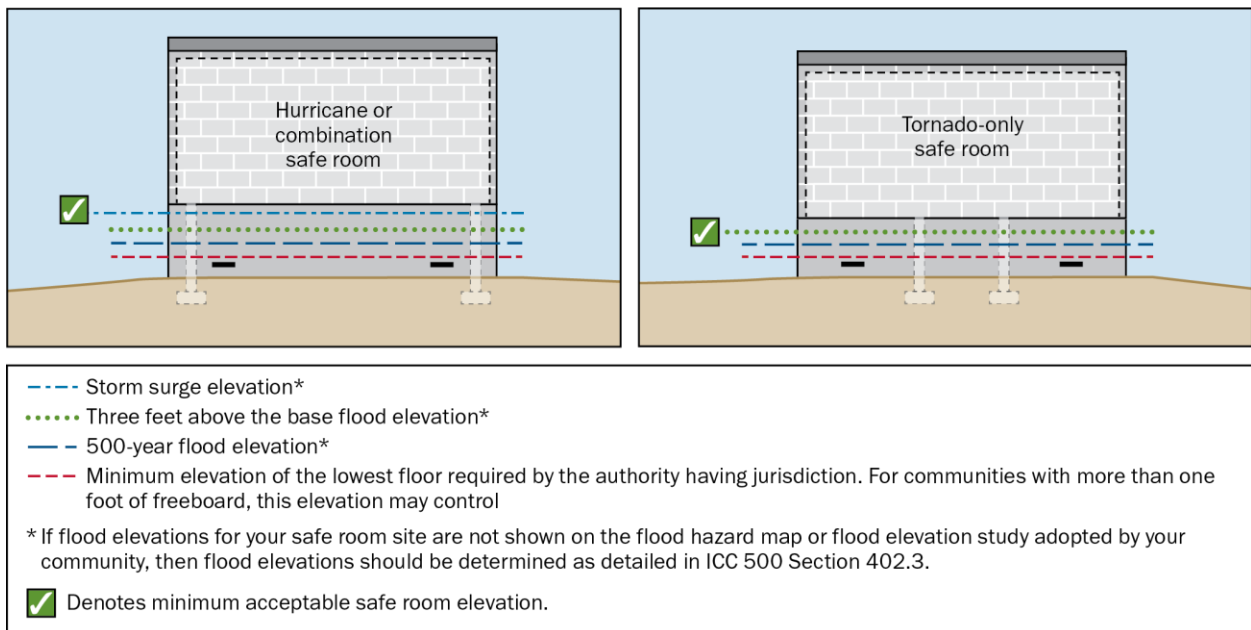

Figure B4-3: Illustration of community safe room examples that meet flood elevation criteria (assuming siting requirements are met)

B4.2.3.3 Flood Design Criteria for Residential Safe Rooms

The design criteria for residential safe rooms are different than for community safe rooms. FEMA Funding Criteria specify that residential safe rooms not be sited in any area that is subject to inundation by coastal storm surge associated with the maximum intensity hurricane.

A residential safe room, as prescribed in FEMA P-320 or designed to the criteria presented in this publication, should not be located within the SFHA if at all possible (see Section B4.1). If it is not possible to site a residential safe room outside the SFHA, the residential safe room should at least be placed outside of the high hazard areas identified in Section B4.1, and (except for the residential basement exception communities [see Section B4.2.2.1, “In-ground safe rooms”]) the top of the safe room floor should be elevated to the highest flood hazard elevation identified in Section B4.1. Designers should be sure to refer to local floodplain management ordinances, which may have additional requirements that restrict the location and configuration (above or below ground) of a residential safe room.

The prescriptive designs presented in FEMA P-320 can only be elevated a few feet above existing grade (see design drawings in that publication for specific details and elevation limitations) and, therefore, may not comply with flood design criteria for residential safe rooms. In such situations, homeowners are advised to retain a structural engineer to design a site-specific foundation for the safe room.

Figure B4-4 shows mapped flood zones. Indicated on the figure are preferred, allowable, and restricted locations for residential safe rooms with respect to mapped flood hazard zones. The yellow and green checkmark locations shown on the figure are acceptable assuming that elevation requirements for the yellow checkmark locations are met. Figure B4-5 shows an example of a shoreline perpendicular transect, complementing Figure B4-4, to indicate which flood zone areas residential safe rooms may be sited within.

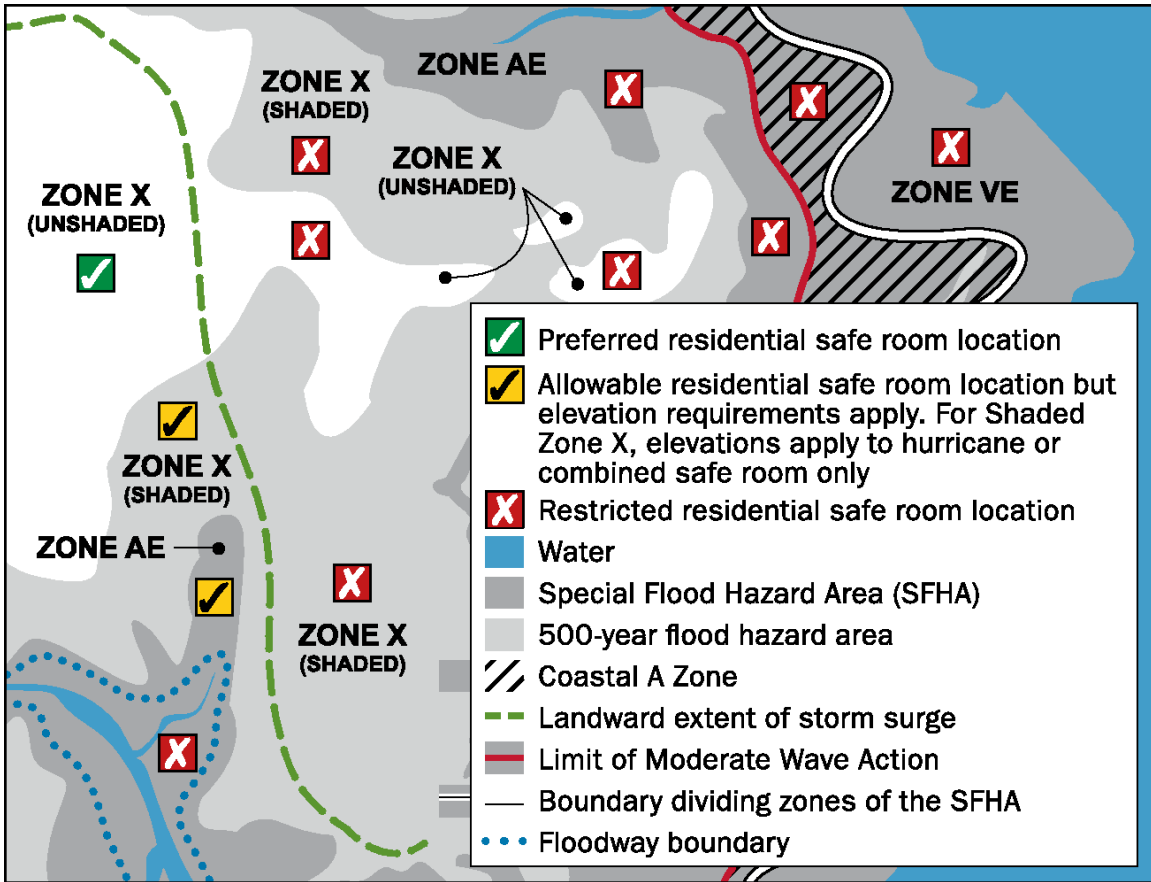

Figure B4-4: Example illustration of preferred, allowable, and restricted residential safe room locations

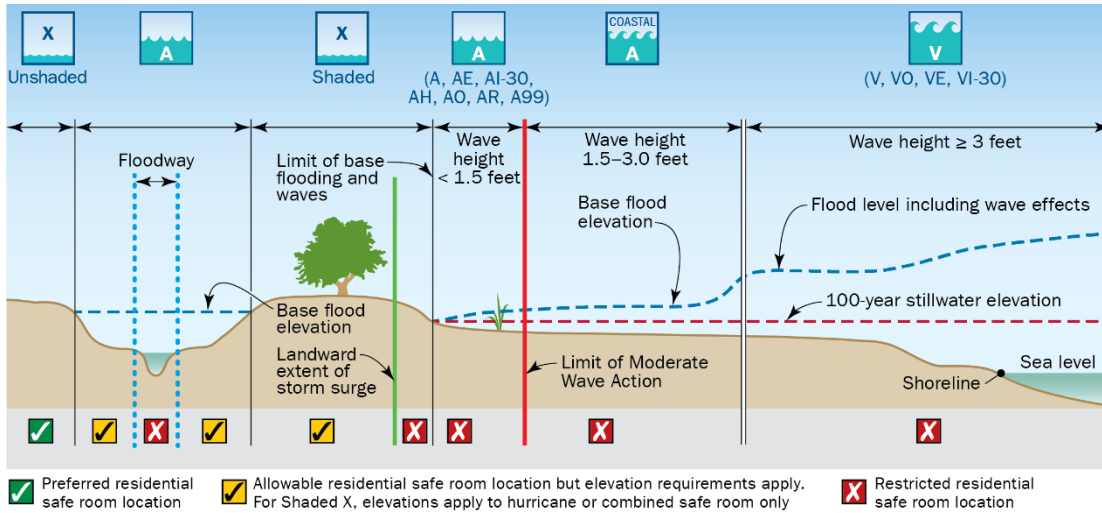

Figure B4-5: Example illustration of a typical riverine cross section and perpendicular shoreline transect showing stillwater and wave crest elevations and associated flood zones for residential safe room siting

Figure B4-6 illustrates a safe room elevated to meet all of the flood elevation criteria for residential safe rooms. Figure B4-6 is an example, so the relative height of each elevation shown on the figure is not necessarily applicable to all locations. For instance, the 500-year flood elevation may not always be higher than the minimum elevation required by the authority having jurisdiction.

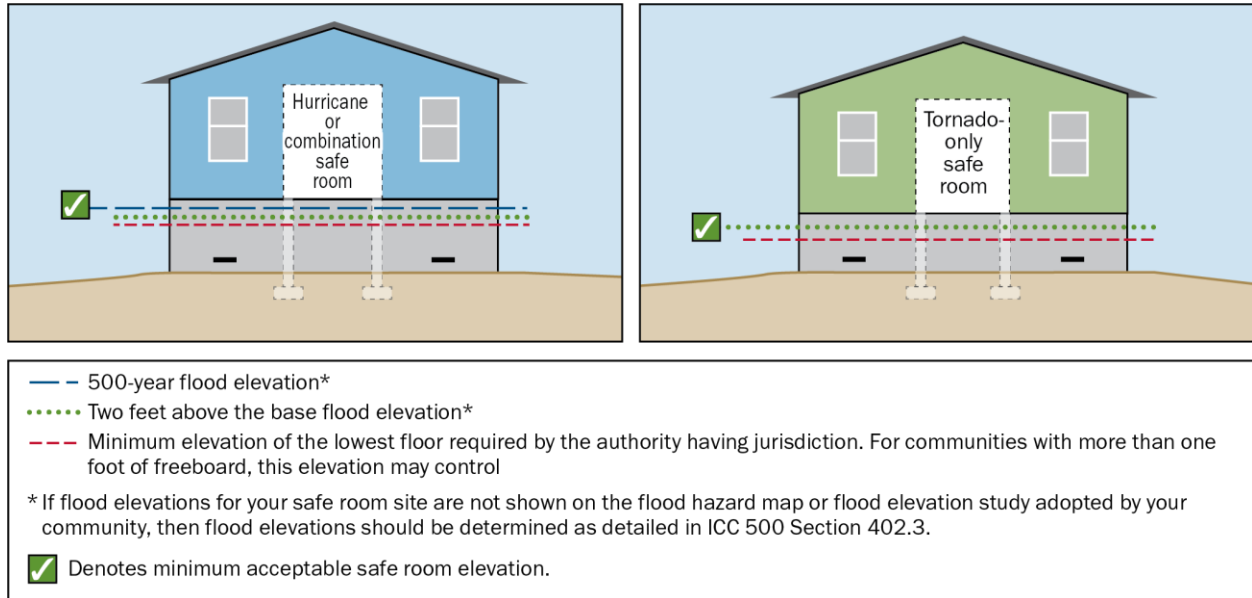

Figure B4-6: Illustration of residential safe room examples that meet flood elevation criteria (assuming siting requirements are met)

Chapter B5 Occupant Density, Entry, Accessibility, Egress, and Signage

This chapter uses Chapter 5 of ICC 500 as the referenced standard and provides background information on criteria to help owners, planners, and design professionals understand the issues. This chapter also includes FEMA additional guidance on occupant density, entry, accessibility, egress, and signage based on many years of field observations and investigations related to safe room performance.

B5.1 Criteria

Safe room occupant density, entry, accessibility, egress, and signage should be designed and constructed in accordance with the provisions of Chapter 5 in ICC 500. No additional FEMA Funding Criteria are required for FEMA-funded safe rooms.

B5.2 FEMA Additional Guidance

FEMA offers the following background information and guidance for the criteria referenced in ICC 500 Chapter 5.

Background on underlying building code criteria: The ICC 500 criteria for occupant density, entry, accessibility, egress, and signage are intended to mirror those requirements set out in the IBC, where for multi-use safe rooms, the normal occupancy of the safe room is used, and for single-use safe rooms, occupancy Assembly 3 (A-3) is used.⁸ Additional requirements, based on the specific type of safe room, are added to the requirements for the normal occupancy of the space. The minimum area per occupant criteria for safe rooms in ICC 500 are based on the use of the space during a storm event and are not intended to be space recommendations for a safe room that might be used as a recovery shelter following the hurricane and/or tornado incident. For more information on operational considerations for safe rooms, see Chapter A4.

CROSS-REFERENCE

For more information on the expected period of occupancy for hurricane and tornado safe rooms, see Sections B7.2.1 and A4.1.3.

⁸ ICC 500 allows single-use safe rooms with fewer than 50 occupants to be designated as Group B occupancy and residential safe rooms as Group R (or in accordance with the IRC where applicable).

B5.2.1 OCCUPANT DENSITY

Safe room occupant density requirements vary with storm type as a function of the expected minimum period of safe room occupancy and safe room type, community (Section B5.2.1.1) or residential (Section B5.2.1.2). Occupant density considerations include determination of usable space to ensure that the safe room provides minimum usable floor area for the design occupant capacity.

B5.2.1.1 Occupant Density in Community Safe Rooms (Reference: ICC 500 Sec 502)

From a design and construction standpoint, there is no limitation on the maximum population that a safe room may be designed to protect. However, safe rooms for very large populations may be deemed outside the scope of FEMA grant funding as described at the end of Section A1.1.

The number of occupants anticipated in a safe room should be carefully considered so that sufficient space is afforded to occupants.

- For tornado safe rooms, where warning times are short, expected capacity typically draws on a relatively small area of the nearby population.
- For hurricane safe rooms, where warning times are considerably longer and mandatory evacuations are often put into place for flood-prone areas, more complex considerations need to be made.

In the case of both hazards, the *HMA Program and Policy Guide* should be consulted on how to determine the maximum capacity based on the location of the safe room with respect to the surrounding population. In the case of hurricane safe rooms in particular, emergency management officials should be consulted to determine under which situations the safe room would and would not be used.

In determining the maximum number of people who will use the safe room, the RDP should assume that the safe room will be used at the time of day when the maximum number of occupants is expected. The planning process of the safe room should also consider the potential for an increase in the number of occupants over time.

FEMA recommends that prospective safe room owners or designers who are planning a safe room project request the HMA safe room population guidance from the FEMA Region or state grant personnel, in the case that the *HMA Program and Policy Guide* has changed since publication of FEMA P-361 (2024). Regardless of the means by which the appropriate safe room population has been identified, the design occupant capacity is required to be posted in the safe room area as described under “Design information signage” in Section B5.2.8.

ICC 500 Section 502.2 Background

The ICC 500 criteria for community storm shelter and safe room maximum population densities are included here to benefit planners by providing specific context for the guidance.

Tornado safe rooms: ICC 500 Section 502.2 requires a minimum of 5 square feet per person for standing or seated occupants for community tornado safe rooms. This requirement is the same as provided in past editions of FEMA P-361 and is an appropriate minimum for a community tornado safe room. For occupants using wheelchairs and occupants who are in a bed or stretcher, the required usable floor area per occupant is higher (10 and 30 square feet per occupant, respectively). However, each community safe room should be sized to accommodate a minimum of one wheelchair space for every 200 occupants or portion thereof. These values are provided in Figure B5-1; guidance on usable area calculations is provided at the end of this section.

Table B5-1: Occupant Density for Community Tornado Safe Rooms

Tornado Safe Room Type of Occupant	Minimum Usable Floor Area ^(a) in Square Feet per Safe Room Occupant
Standing or Seated	5
Using a Wheelchair	10
Relocated to a Bed or Stretcher	30

Note:

(a) See Section B5.2.1.1 for guidance on minimum usable safe room floor area.

Code-specified occupant density limits for the normal use of multi-use community tornado safe rooms may conflict with safe room occupant density criteria described in this section. For example, referencing IBC Section 1004 (Occupant Load), the floor area allowance for educational classroom areas is 20 square feet per person, but for a tornado safe room is 5 square feet per person (per ICC 500 and FEMA P-361). Accordingly, using a classroom area in a school as a safe room can create a potential conflict in the allowed numbers of persons in the safe room if it does not have proper signage and posted capacity requirements. If both the normal occupant load and safe room maximum capacity are posted, and the safe room capacity is based on no less than the minimum 5 square feet per person then the safe room design should be acceptable to the authority having jurisdiction.

It is not the intent of ICC 500 or FEMA to require the tornado storm shelter or safe room to be designed to accommodate the total occupant load of the host building, which is much greater than the actual number of host building occupants at any given time. The total host building occupant load—based on fire exiting considerations—includes occupant loads for all host building spaces simultaneously and is used to determine the required means of egress for normal use. As a result, the total occupant load for the building would be excessive for storm shelter or safe room design capacity, which should be based on the number of intended occupants to be protected. Once the number of intended safe room occupants is decided, the density table is used for determining the minimum usable floor area.

Hurricane safe rooms: For hurricane community storm shelters, ICC 500 Section 502.2 requires a minimum of 20 square feet per standing, seated, or wheelchair-using occupant. Because this

publication provides no additional FEMA Funding Criteria for occupant densities, the standard criteria govern both storm shelters and safe rooms. See Table B5-2 for usable space criteria for all types of community hurricane safe room occupants.

Table B5-2: Occupant Density for Community Hurricane Safe Rooms

Hurricane Safe Room Type of Occupant	Minimum Usable Floor Area ^(a) in Square Feet per Safe Room Occupant
Standing or Seated	20
Using a Wheelchair	20
Relocated to a Bed or Stretcher	40

Note:

(a) See Section B5.2.1.1 for guidance on minimum usable safe room floor area.

As with community tornado safe rooms, differences may arise between code-specified normal use occupant loads and multi-use community hurricane safe room design occupant capacities. For example, according to the IBC Section 1004, the floor area allowance for assembly space without fixed seats (“concentrated”) is 7 net square feet per person, but a community hurricane safe room requires 20 square feet per standing, seated, or wheelchair-using occupant (per FEMA P-361 and ICC 500). Therefore, when used as a community hurricane safe room, the multi-use space is designed to hold fewer occupants than when used for assemblies.

The number of standing, seated, wheelchair-using, or bedridden spaces should be determined based on the needs of the potential safe room users, as determined by the designer and approved by the authority having jurisdiction.

Calculation of Usable Floor Area of a Community Safe Room (Reference: ICC 500 Sec 502.4)

Determining usable floor area in a community safe room is not always straightforward because of the configuration of the interior. Either of the calculation methods described in this section can be used to determine the usable floor area; the methods may also be combined. For almost all spaces, the usable floor area is less than the building footprint after subtracting the interior columns, walls, or partitions; permanently mounted desks, chairs, or tables; or the storage area required to store portable desks, chairs, and tables.

In accordance with ICC 500 Section 502.4, safe room useable floor areas cannot include occupant support areas (refer to definition in Chapter B2). But an exception is provided for community tornado storm shelter and safe room restrooms where 1) the entire storm shelter is a single occupant toilet area, or 2) the shelter includes multi-stall toilet rooms. For the latter case, only restroom areas outside toilet stalls and temporary toilet stations may be counted towards the total usable floor area. Conversely, community hurricane safe rooms may not count restroom areas towards the total usable floor area.

NOTE**Square Footage**

The ICC 500 square-footage requirement is an increase over the first edition of FEMA P-361 community hurricane safe room criteria. The increase is a result of discussions among FEMA and the ICC 500 Standard Committee, and data gathered about shelters after hurricanes in 2004 and 2005. The ICC 500 requirement is in line with recommendations in American Red Cross publication ARC 4496, *Standards for Hurricane Evacuation Shelter Selection* (2002).

One method for determining the safe room usable floor area is to use the following percentages derived from FEMA's National Facility Survey and adjusted based on recommendations from ICC 500 committee members:

- Reduce the gross floor area of safe rooms with concentrated furnishings or fixed seating by at least 50%
- Reduce the gross floor area of safe rooms with unconcentrated furnishings and without fixed seating by at least 35%
- Reduce the gross floor area of safe rooms with open plan furnishings and without fixed seating by at least 15%

A second method for determining the safe room usable floor area is to subtract unusable areas from the gross floor area:

- Reduce the gross area of the safe room (the footprint) by excluding spaces associated with partitions and walls, columns, fixed or movable equipment, or any other features that cannot be "removed under probable conditions" when used as a safe room. The remaining area is considered the safe room usable floor area.

The first method of using percentages based on the type of furnishings and fixtures in the safe room may be more appropriate for safe rooms that have only preliminary or conceptual designs in place. In most cases, the usable floor area is calculated early in the design phase of the safe room, when detailed design drawings showing the type of obstructions considered in the second method are not available. Combining the methods may result in more efficient use of space where sufficient detail on use is ready for some but not all spaces within the safe room envelope. Safe room designers and planners should also be aware that the percentages should be applied to the total gross floor area of the safe room (see "Gross Floor Area" definition in the IBC).

B5.2.1.2 Occupant Density in Residential Safe Rooms (Reference: ICC 500 Sec 503)

A residential safe room is defined as a safe room serving occupants of dwelling units and having an occupant load not exceeding 16 persons. The ICC 500 criteria for minimum usable floor area per

occupant in residential safe rooms are described below and included in Table B5-3 to benefit planners by providing specific context for the additional guidance in this section.

Table B5-3: Occupant Density for Residential Safe Rooms

Type of Safe Room	Minimum Usable Floor Area in Square Feet per Safe Room Occupant
Tornado:	
One- and Two-Family Dwelling	3
Other Residential	5
Hurricane:	
One- and Two- Family Dwelling	7
Other Residential	10

Calculation of Usable Floor Area of a Residential Safe Room (Reference: ICC 500 Sec 503.3)

The usable floor area for residential safe rooms should be determined by subtracting unusable floor areas from the gross floor area. Unusable areas should include partitions and walls, columns, fixed or movable equipment, or any other features that cannot be “removed under probable conditions” when the space is used as a safe room.

B5.2.2 ENTRY AND EGRESS FOR COMMUNITY SAFE ROOMS (REFERENCE: ICC 500 SEC 504)

Entry and egress considerations for community storm shelters and safe rooms include protection of all entry/egress openings in the storm shelter/safe room envelope (see Section B3.2.6), accessibility, and requirements for doors and/or emergency escape openings. Directly related content on community safe room entry and egress include “Vertical Access and Egress” (see B5.2.6) and “Latching” (B5.2.7). Additionally, ICC 500 Section 603 (Fire Separation) provides fire-rating requirements for doors and shutters that are located in fire-resistant wall assemblies as well as exceptions to fire separation requirements in exchange for additional egress options (see Section B6.2.3 for more information).

B5.2.2.1 Accessibility (Reference: ICC 500 Sec 504.2)

ICC 500 requires “accessibility in accordance with the applicable code” for community storm shelters. FEMA Funding Criteria do not specify any differences with the standard in terms of accessibility, but safe room designers, owners, and operators should be prepared to demonstrate how their community safe room provides equal access for all persons in accordance with the requirements of the Americans with Disabilities Act (ADA) requirements and ordinances. Additionally, safe room designers should be aware that accessibility provisions of the applicable code, state

requirements, and local ordinances may exceed the minimum requirements of the ADA. For example, provisions for accessible routes connecting multistory buildings in Section 1104.4 of the 2024 IBC are more extensive than similar criteria in the ADA.

More Information

For more information about providing for the needs of persons with disabilities during emergencies, refer to the FEMA and U.S. Fire Administration publication FA 154, *Emergency Procedures for Employees with Disabilities in Office Occupancies* (undated). Additional guidance for compliance with the ADA is available at <https://www.adachecklist.org/doc/fullchecklist/ada-checklist.pdf>.

All safe rooms should be managed in accordance with an O&M plan. Guidelines for preparing safe room operations plans are provided in Chapter A4 for community safe rooms. The RDP can help safe room operators understand accessibility requirements of the ADA and the applicable code and assist the owner/operator of the safe room in developing the operations plan. Developing a sound operations plan is extremely important when ADA compliance requires the use of lifts, elevators, ramps, or other considerations for safe rooms that are not directly accessible to non-ambulatory persons.

NOTE

The Rehabilitation Act of 1973, as Amended, Including Section 504, Programs, Services and Activities (29 U.S.C. § 794)

Federal agencies and those receiving federal assistance must ensure that their programs are usable and accessible to persons with disabilities. Compliance may include making changes to policies, practices, procedures, and structures as a reasonable accommodation for individuals with disabilities in accordance with Section 504 of the Rehabilitation Act. Section 504 also applies to organizations and entities that receive federal monies distributed through state or local agencies (subrecipients).

Travel Time and Access

Travel time and access are important elements of safe room design. If obstructions exist along the travel route, or if the safe room is cluttered with non-essential equipment and storage items, access to the safe room will be impeded. Travel time may be especially important when safe room users have disabilities that affect their mobility and may need assistance from others to reach the safe room. In addition, wheelchair users may need a particular route that accommodates wheelchairs. The designer should consider these factors in the initial safe room planning phase and provide the shortest possible access time and most accessible route for all potential safe room occupants.

Access and Functional Needs

Public safe rooms must meet the accessibility requirements of the ADA and have a schematic identifying accessible pathways from the safe room entrance, accessible bathrooms (see Section

B7.2.2 for specific guidance), sites for backup power and electrical hookup to power necessary equipment, and the location of refrigeration. For guidance, refer to the *ADA Checklist for Emergency Shelters* (U.S. Department of Justice, 2007), available at <https://www.ada.gov/pcatoolkit/chap7shelterchk.pdf>, and *2010 ADA Standards for Accessible Design* (“2010 Standards” or “Standards”) (U.S. Department of Justice, 2010) or most current edition, available at https://www.ada.gov/2010ADASTANDARDS_index.htm. The 2010 Standards set minimum requirements, both scoping and technical, for newly designed and constructed or altered state and local government facilities, public accommodations, and commercial facilities to be readily accessible to and usable by individuals with disabilities.

More Information

For considerations related to planning safe rooms that may house occupants with access and functional needs, refer to FEMA’s *Guidance on Planning for Integration of Functional Needs Support Services in General Population Shelters* (2010), which can be accessed at https://www.fema.gov/pdf/about/odc/fnss_guidance.pdf.

B5.2.2.2 Egress Doors (Reference: ICC 500 Sec 504.4)

Multi-use community safe room egress capacity, including the number of doors and the total net egress, should be determined based on the occupant load for the normal occupancy of the space in accordance with the applicable code. For facilities used solely as safe rooms, the egress capacity should be determined based on the occupant load of the safe room in accordance with the applicable code.

The following example illustrates how multi-use safe room egress capacity requirements are developed and how they compare with egress capacity requirements for the safe room if it was designed and designated as a single-use community tornado safe room. For this example, the normal use of the multi-use community tornado safe room is an educational classroom:

- According to Table 1004.5 in the 2024 IBC, for a 4,800-net-square-foot⁹ educational classroom, the normal occupant load is 20 square feet per person ($4,800/20 = 240$ people), while the tornado safe room’s maximum design occupant capacity is 5 square feet per standing or seated occupant ($4,800/5 = 960$ people). When reduced for the minimum 5 wheelchair-using occupants, the maximum design occupant capacity is 955 people.
- For both classroom (Group E) and safe room (Group A-3, where dedicated storm shelter) uses, Section 1005.3.2 of the 2024 IBC requires a means of egress capacity factor of 0.2 inch per occupant for means of egress components other than stairways.

⁹ Net square footage should be approximately equal to usable floor area for storm shelters (and safe rooms) where determining minimum usable floor area in accordance with ICC 500 Section 502.4.2, “Alternate calculation of usable floor area.”

- For normal (classroom) use, this calculates to 48 inches (240*0.2 inch) of required egress and a minimum of two doors¹⁰ (exits); therefore, two 32-inch doors (64-inch total net egress) should be provided.
- For single-use community tornado safe rooms with 4,800 net-square-feet and a design occupant capacity of 955, the requirement is for 191 inches (955*0.2 inch) and a minimum of three doors (exits); therefore, six 32-inch doors (192-inch total net egress) should be provided.
- Since safe room means of egress are permitted to be determined based on the normal occupancy of the space, 48-inch total net egress is the code-required minimum for the multi-use community tornado safe room in this example.
- If the community tornado safe room in this example was single-use (aka “dedicated”), then more egress (191-inch total net egress) would be required.

Normal use for the space in the referenced example was educational classroom, which generated lower occupant load and egress capacity requirements than if the community tornado safe room was designated as a single-use (or “dedicated”) facility. However, the usable floor space required for standing, seated, or wheelchair-using community hurricane safe room occupants is four times greater than that required for standing or seated community tornado safe room occupants (20 square feet vs. 5 square feet). As a result, the normal use of multi-use community hurricane safe rooms may serve to increase the required amount of egress when compared to a single-use community hurricane safe room with the same occupant capacity.

Where the applicable code requires only one means of egress door from community safe rooms, one additional means of egress is required if the design occupant capacity is greater than 16. The additional egress may be provided by an emergency escape opening or overhead hatch (see Section B5.2.5).

NOTE

Door Swing

The direction of the door swing should be as required by the applicable building code for the normal occupancy of the space, and the egress doors should be operable from the inside without keys or special knowledge or effort.

Designers are encouraged to not only consider egress for safe rooms, but entry as well. Safe rooms—particularly those in highly populated buildings such as schools—may have a large number of people attempting to get into the protected space at once. Employing common sense strategies, such as sizing hallways and doorways to be equivalent widths (to reduce the bottleneck effect) and

¹⁰ Reference 2024 IBC Section 1006.2.1 for minimum number of exit or exit access doorway requirements.

strategically locating entrances, can help facilitate a continuous flow of occupants into the safe room during an emergency. However, designers should keep in mind that egress code requirements are based on fire hazard and demand a very rapid exit from the area; there may be more time for ingress movement of occupants into a tornado safe room. Further, designers considering adding openings should remember that the greater the number and size of openings in the safe room envelope, the greater the potential for the envelope to be compromised during a tornado or hurricane.

B5.2.2.3 Emergency Escape Opening and overhead hatches (Reference: ICC 500 Sec 504.5 through 504.6)

Where the applicable building code requires only one means of egress for a safe room with more than 16 occupants, an emergency escape opening is required per Section 504.4 of ICC 500. Acceptable emergency escape openings are defined in Sections 504.5 and 504.6 and should be an additional door or an opening with the following dimensions:

- Minimum net clear opening area = 5.7 square feet
- Minimum net clear opening height = 24 inches
- Minimum net clear opening width = 20 inches

The emergency escape opening should be operable from the inside without the use of tools or special knowledge. If the bottom of the emergency escape opening is located more than 44 inches above the floor, then vertical access—emergency stair, ladder, or alternating tread device—is required (see Section B5.2.6). On the other hand, if the emergency escape opening is located 44 inches or less above the floor, then not only is vertical access not required but the minimum net clear opening may be decreased to 5.0 square feet (no decrease provided for minimum height or width).

ICC 500-2023 has added additional emergency escape opening requirements to decrease the probability of both the egress door and emergency escape opening being blocked by post-storm debris. The first requires the opening be located on an opposite wall, perpendicular wall, roof, or floor from the means of egress door “where practicable.” The second requires the opening and the egress door be separated by a distance of at least one-third the overall diagonal dimension of the shelter as measured horizontally between any point on the two openings. Parallel requirements were added for overhead hatches in Section 504.6.

B5.2.3 ENTRY AND EGRESS FOR RESIDENTIAL SAFE ROOM (REFERENCE: ICC 500 SEC 505)

Entry and egress for residential safe rooms can be provided by an egress door or an entry and egress opening (minimum clear opening of 30 inches by 24 inches). Requirements for each opening type and vertical access (where required) are provided in ICC 500 Sections 505 and 506. Regardless of the type, the opening created in the safe room envelope (i.e., wall or roof assembly) to provide the required entry and egress opening must be covered by an impact-protective system that complies

with the testing requirements specified in ICC 500 Section 304.6. An emergency escape opening, in addition to the egress door, is not required.

B5.2.4 VERTICAL ACCESS AND EGRESS (REFERENCE: ICC 500 SEC 506)

Vertical access and egress provisions for community and residential storm shelters are provided in Section 506 of ICC 500. Because there are no differences between FEMA Funding Criteria and ICC 500 for vertical access and egress, the standard governs both storm shelters and safe rooms. Compared with normal-use stairway requirements in the IBC or IRC, storm shelters can employ emergency stairs (narrower and steeper than IBC-compliant stairways) to access overhead hatches and raised openings. Vertical access may also be provided through ladders or alternating tread devices that comply with ICC 500 Section 506, which also includes requirements for handrails, headroom, and overhead hatches.

B5.2.5 LATCHING (REFERENCE: ICC 500 SEC 507)

Model building codes and life-safety codes include requirements for securing egress doors in public areas (areas with assembly classifications). These codes often require panic bar hardware, single-release mechanisms, or other hardware requirements. For example, the 2024 IBC and the NFPA life-safety codes require panic bar hardware with no other lock or latch on swinging doors for assembly and educational occupancies of 50 persons or more. The RDP will need to establish what type of door hardware is required by the applicable code and ICC 500 and what hardware is permitted (i.e., part of a safe room door assembly that passed ICC 500 impact and pressure testing).

Furthermore, most codes will not permit primary or supplemental locking mechanisms that require more than one action to achieve egress, such as deadbolts, to be placed on the door of any area with an assembly occupancy group classification, even if the intended use would only be during an extreme-wind event. This restriction is also common for school occupancy group classifications.

Unlike the applicable code requirements for normal use that are described above, ICC 500 latching mechanism requirements extend beyond door assemblies to cover all impact-protective systems.

Operating Hardware

ICC 500 Section 507.4 requires that operating hardware on the non-egress side of the safe room door not be susceptible to unintentional unlatching by debris impact. So, if panic hardware is used on a safe room door (and in many cases, it may be required by code), the swing of the door should be such that the placement of panic devices is on the interior of the safe room. Push bars are activated with only 15 pounds of force, so when placed on the exterior of the safe room they are likely to be triggered by high wind pressures or wind-borne debris, allowing the door to open unintentionally.

Similarly, doors with hardware trim on the exterior should have a locking mechanism that disables the exterior door handle so that debris hitting the door handle will not unlatch the hardware and

potentially open the door. Further, latching and locking mechanisms are not allowed to prohibit egress from the safe room.

As described in Section A4.5.2, Entering the Safe Room, some community safe rooms have been installed with locks that can be operated remotely to facilitate more efficient access, which is especially critical during tornadoes. In response, requirements have been added to ICC 500 to ensure that occupants have the ability to secure IPS within the storm shelter or safe room where latching or locking is electronically controlled.

B5.2.6 SIGNAGE FOR SAFE ROOMS (REFERENCE: ICC 500 SEC 508)

Residential safe rooms are only required to have design information signs (see item 1 below). All community safe rooms are required to have design information signs, safe room entry signs, and safe room perimeter signs; directional signs are required for community safe rooms only where applicable. Additional information on the four types of safe room signs follows:

1. Design information signs should indicate the following information: 1) safe room design occupant capacity; 2) storm type; 3) safe room design tornado speed, wind speed, or both; 4) edition of ICC 500 and FEMA P-361 used for design; and 5) name of safe room builder or manufacturer.
2. Safe room directional signs should direct the intended occupants to the safe room by depicting the general location of the safe room(s) and access ways. Directional signs are needed on sites where the safe room serves the general public, intended occupants from multiple buildings, and intended occupants within host buildings. Each of the following types of directional signs are required where applicable only:
 - a. Exterior directional signs are required to direct off-site, general public users to the safe room. For example, signage on the safe room property may direct the general users to the designated parking area and from the parking area to the safe room entrance. One or multiple signs may be needed depending on the situation.
 - b. Directional signage for multi-building sites is needed to direct the intended users from known buildings to the safe room. Signage may be within non-safe room buildings, between the buildings and the safe room, or both.
 - c. Where the safe room is located within a host building, directional signage is required within the host building to mark the path of travel to the safe room where the route is not “readily apparent.”
3. A safe room entry sign should be installed at every entrance to the safe room, indicating “Tornado Safe Room” or “Hurricane Safe Room” or “Hurricane and Tornado Safe Room.” Entry sign examples are shown on the following page in Figure B5-1.
4. A safe room perimeter sign should be posted on the interior and adjacent to each exit from the safe room protected area indicating “Notice: Now leaving the Tornado Safe Room” or “Notice: Now leaving the Hurricane Safe Room.”

All Directional, Entry, and Perimeter signage should conform to the visual character requirements of ICC A117.1, *Accessible and Usable Buildings and Facilities (2017a)*. For more information on signage considerations from an operations perspective, including guidance specific to safe rooms open to the general public and for those open to intended occupants only, see Section A4.3.2.

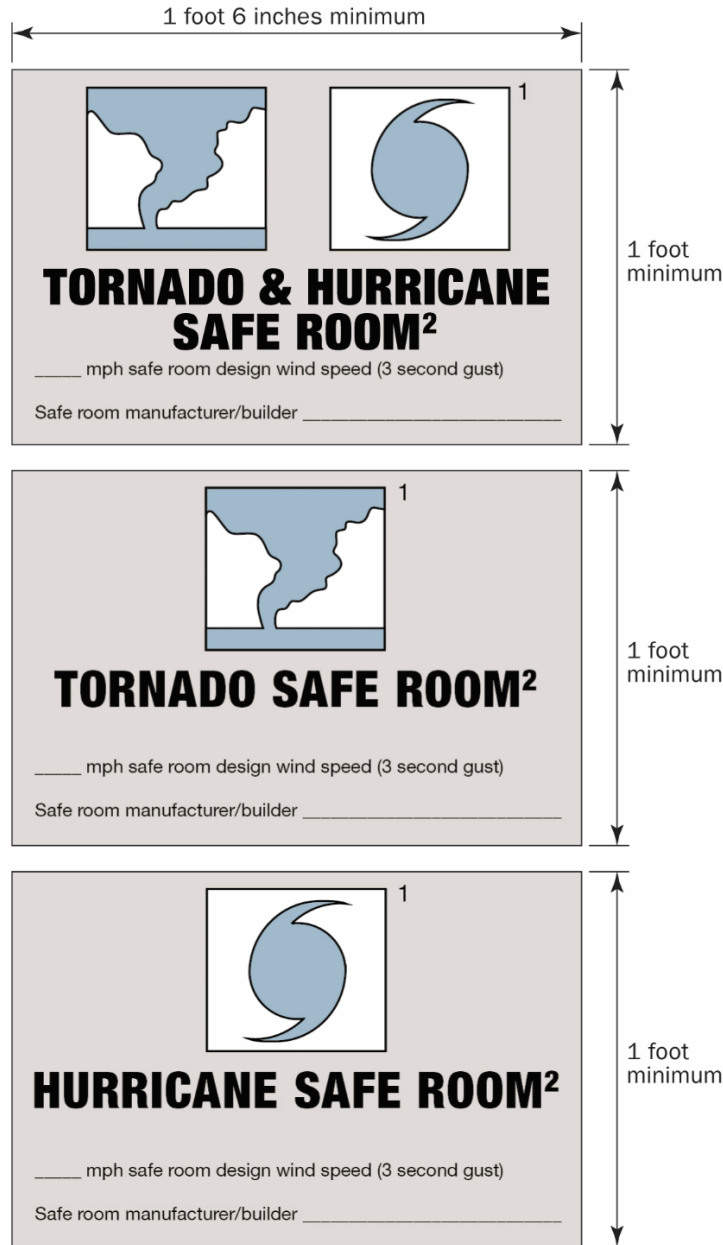

1. The applicable picture should be shown for the hazard(s) the safe room has been designed to resist: tornado, hurricane, or combined (show both pictures).
2. The applicable hazard should be shown here. For a safe room designed to resist both hurricanes and tornadoes, use the term "combined."

Figure B5-1: Safe room entry sign examples

This page left blank intentionally

Chapter B6 Fire Safety

This chapter uses Chapter 6 of ICC 500 as the referenced standard and includes a list of FEMA Funding Criteria that FEMA has identified as more conservative than the provisions in Chapter 6 of ICC 500. This chapter also includes FEMA additional guidance on fire safety based on many years of field observations and investigations related to safe room performance.

B6.1 Criteria

Safe rooms should be designed and constructed in accordance with the fire safety provisions of Chapter 6 in ICC 500 as amended by FEMA's Funding Criteria as shown in Table B6-1.

FEMA Safe Room Grant Requirements

Whenever a safe room is constructed using FEMA grant funds, the FEMA Funding Criteria shown in Section B6.1 become requirements in addition to the requirements of ICC 500 Chapter 6.

Table B6-1: Comparison of ICC 500 Requirements to FEMA Funding Criteria

ICC 500 Reference ^(a)	ICC 500 Requirement	FEMA Funding Criteria ^(b)
Section 603.1 Fire-Resistant Rated Construction	<p>Walls and horizontal assemblies between <i>community storm shelters</i> and <i>host building</i> areas shall be fire barriers or horizontal assemblies with a minimum fire-resistance rating of 2 hours constructed in accordance with the <i>applicable code</i>.</p> <p>Exceptions: Walls and horizontal assemblies are not required to be fire-resistance rated with any of the following configurations:</p> <ol style="list-style-type: none"> 1. Design occupant capacity of 16 or fewer. 2. Storm shelter is located in the basement or underground, the design occupant capacity is less than 50, at least two egress doors are provided and the egress doors are separated by a minimum horizontal distance equal to $\frac{1}{3}$ of the overall diagonal dimension of the storm shelter. 3. Design occupant capacity is less than 50 and an egress door, overhead hatch or emergency escape opening opens directly to the exterior of the building. 4. Means of egress is designed in accordance with the applicable code for the design occupant capacity, the storm shelter has at least two egress doors and at least at 50% of the total required capacity for the means of egress from the storm shelter is directly to the exterior of the building. 	<p>Walls and horizontal assemblies between <i>community safe rooms</i> and <i>host building</i> areas shall be fire barriers or horizontal assemblies with a minimum fire-resistance rating of 2 hours constructed in accordance with the <i>applicable code</i>.</p> <p>No exceptions apply.^(c)</p>

Bolded text denotes differences between the ICC 500 Requirement and the FEMA Funding Criteria.

Notes:

(a) ICC 500 language reprinted here with permission from the International Code Council.

(b) Table only lists requirements where there are differences between FEMA Funding Criteria and ICC 500 Chapter 6. All ICC 500 Chapter 6 requirements not listed in the table should also be met in their entirety. Safe room types (e.g., community, residential, tornado, hurricane) outside the scope of any given FEMA Funding Criterion need only meet the corresponding ICC 500 criteria (where applicable).

(c) The noted FEMA Funding Criteria apply to community safe rooms only. Neither residential storm shelters nor residential safe rooms are required to comply with ICC 500 Section 603.1.

B6.2 FEMA Additional Guidance

FEMA offers the following background information and guidance for the criteria referenced in ICC 500 Chapter 6 or presented as FEMA Funding Criteria in Section B6.1.

B6.2.1 FEMA FUNDING CRITERIA: SAFE ROOM FIRE SAFETY

ICC 500-2020 introduced more standard-specific fire safety requirements than past editions; the 2023 edition had very few changes though. The standard and FEMA guidance still reference the IBC for host building fire safety provisions, which extend to the storm shelter or safe room unless the standard or FEMA specifies otherwise. The IBC addresses fire safety primarily through a combination of active and passive fire protection systems. The two systems work together to protect building occupants from fire by detecting and suppressing smoke and fire and by alerting and guiding building occupants through fire-resistance-rated exits or protected enclosures to the outside of the building. As evacuees move towards the building discharge, fire resistance ratings increase to facilitate egress. The strategy has served to save countless lives and continues to evolve across ongoing code and standard cycles. ICC 500 defers to the fire protection features prescribed by the IBC/IRC and does not require additional protection beyond strategic placement of handheld extinguishers and the fire-resistance-rated construction of the storm shelter.

Storm shelters and safe rooms provide life-safety protection from extreme wind incidents by keeping building occupants within the storm shelter envelope, which has been designed to resist wind loads and wind-borne debris impacts associated with tornadoes and hurricanes. As a result, ICC 500 addresses fire safety by treating the storm shelter as a protected enclosure separated from the host building where occupants are equipped with fire extinguishers to “defend in place” against minor fire and smoke hazards (e.g., wastebasket or cooking area fire) while remaining in the shelter until the storm has passed. This approach has been supported by FEMA’s safe room guidance since ICC 500 was first published.

Given the conflicting strategies of protecting building occupants from fire (evacuate from a hazard inside the building) and extreme wind (shelter in place from a hazard outside the building), it is critical to consider the performance objectives of storm shelters and safe rooms when deliberating change. ICC 500 Section 101.1 was clarified in the third edition to state that “The purpose of this standard is to establish minimum requirements to safeguard the public health, safety and general welfare relative to the design, construction and installation of storm shelters constructed for protection from tornadoes, hurricanes and other severe windstorms.” As such, the performance objective of storm shelters is to protect occupants from hazards *directly* associated with the designated storm type (tornado, hurricane, or combined). For example, in addition to the effects of high winds, ICC 500 addresses heavy rainfall and flooding for hurricane storm shelters and APC for tornado storm shelters. Although fire probabilities increase with extreme wind events—often ignited by storm damage-triggered electrical shorts—they are not directly associated with tornadoes or hurricanes.

FEMA’s near-absolute protection performance objective for safe rooms results in criteria that match ICC 500 in most chapters with primary differences related to flood hazard. However, elevating the

lowest floor of tornado safe rooms to avoid damages from flooding or endangering occupants does not conflict with protection from hazards directly associated with tornadoes and hurricanes. For safe room fire safety criteria determinations, it is critical to recognize that the established approach of treating the safe room as a “protected enclosure” where occupants defend against minor fires (only) while “sheltering in place” ultimately serves to prioritize life safety by keeping occupants within the safe room for the duration of the tornado or hurricane if at all possible.

The following sections address fire safety requirements in ICC 500 and provide guidance on corresponding FEMA Funding Criteria based on the code and standard development background described above.

B6.2.2 FIRE PROTECTION SYSTEMS (REFERENCE: ICC 500 SEC 602)

Fire protection systems for multi-use safe rooms should comply with applicable code provisions for the normal use of the space. ICC 500 Chapters 6, 7, and 2 further address the functionality of fire protection systems for multi-use storm shelters as follows:

- Chapter 6 specifies that fire protection systems be provided within the storm shelter where required by the applicable code for the normal use of the space but that the systems are not required to remain functional during the design event or to be protected like the storm shelter critical support systems addressed in Chapter 7.
- Chapter 7 (Section 701.2) requires that critical support systems be protected from the design event for the minimum period of safe room occupancy. Although the requirement is essentially unchanged in Chapter 7, the definition of “critical support systems” in Chapter 2 was modified in ICC 500-2020 to delete life-safety systems from the list.

Terminology

Fire Protection Systems: The International Fire Code® (IFC®) defines fire protection systems as *approved* devices, equipment, and systems or combinations of systems used to detect a fire, activate an alarm, extinguish or control a fire, control or manage smoke and products of a fire, or any combination thereof.

The motivation for the standard changes related to the practicality, feasibility, and cost of installing and protecting two fully independent fire protection systems (including sprinkler water) to provide fire protection during a tornado or hurricane. The committee also carefully assessed the life-safety benefits of protecting a fully independent fire protection system and found them to be lacking. The following points are provided to demonstrate how safe room fire protection systems may affect FEMA’s near-absolute protection objective.

- Since the existing requirements for protecting safe room fire protection systems only apply *within* the safe room, the fire protection provided only protects from smoke and fires within the safe

room. No protection is afforded from fires in the host building; such protection is addressed through separation requirements described in the next section.

- If a fire occurs within the safe room, then it should be indicated by interior smoke alarms (and/or staff designated for fire watch duties) that will direct occupants to exit the safe room unless the incident is deemed minor enough to quickly extinguish.
- Fire suppression systems (e.g., sprinklers) are activated by intense heat and are not intended to be discharged in occupied areas. As such, the protected fire suppression system is much more likely to mitigate fire damage to the safe room itself than to protect safe room occupants who should be evacuated.

CROSS-REFERENCE

Operational preparation and execution are critical to safe room fire safety. See Section A4.6.3.1 for guidance on how to address fire safety in community safe room O&M plans.

For consistency with the established safe room fire safety strategy of defending in place against minor fires and evacuating for more threatening fire and smoke incidents, FEMA recommends that fire protection systems be designed and installed in accordance with the provisions in ICC 500 Section 602.

Because fire protection systems are fully within the protected building envelope of standalone safe rooms, the fire protection system provisions of the applicable code should be met or exceeded without exception.

B6.2.3 FIRE-RESISTANCE-RATED CONSTRUCTION (REFERENCE: ICC 500 SEC 603)

For community safe rooms, ICC 500 requires fire barriers and horizontal assemblies between storm shelters and host building areas to have a minimum fire-resistance rating of 2 hours and be constructed in accordance with the applicable building code. Fire separation assemblies are not required for residential safe rooms or storm shelters.

NOTE

Fire Doors and Shutters

In accordance with ICC 500 Section 603.1.1, safe room fire doors and shutters are not required to be self- or automatic closing if they are installed in fire-barriers that are required solely to comply with Section 603.1 of ICC 500.

Four exceptions to the 2-hour fire separation requirements are now provided in ICC 500. Each of the four exceptions applies to storm shelters based on design occupant capacity, and in three cases, substitute additional egress and/or egress that open to the exterior of the building for fire

separation. Including at least one egress door that opens to the exterior of the building is intended to prevent occupants from having to egress through the fiery, smoke-filled host building. Aside from the exception for storm shelters with design occupant capacities of 16 or less, the other exception that does not require direct egress from the storm shelter to the exterior of the building applies only to basement or below-grade storm shelters with a design occupant capacity of 49 or fewer. In those cases, the 2-hour fire separation may be omitted in exchange for a second egress door (IBC Section 1006 would require one egress door for the same occupant load located a minimum distance [one third of the overall diagonal dimension of the shelter] away and in another wall). Although the second door may open to the interior of the host building, there is less chance that both doors open into areas impassable from fire and/or smoke than if there were only one door.

NOTE

Fire-Rated Assemblies

Many safe room wall and roof assemblies that have passed previous missile impact tests and can be demonstrated through calculations to resist extreme wind pressures have fire separation ratings of 2 hours or more. Such assemblies include reinforced masonry and reinforced concrete (including precast panels and insulated concrete forms). Wood-framed assemblies can meet the 2-hour fire separation through incorporation of gypsum sheathing. However, this path to compliance for safe rooms constructed with steel panels has proven cost ineffective.

How FEMA and ICC 500 have addressed fire safety in part through treating the safe room or storm shelter as a protected enclosure (as discussed in Section B6.2.1) is notably different from how the IBC addresses fire safety. Although similar to the protected enclosure approach in the IBC, ICC 500 stops short of providing the requisite means of egress system for occupants to exit the building through fire-resistance-rated exits and protected enclosures (i.e., separation).

BEST PRACTICE: FEMA recommends that designers provide safe rooms with egress that opens directly to the exterior of the host building. Where safe rooms must be located such that egress cannot open directly to the exterior of the host building, a best practice is to provide exit passageways from the safe room to the exterior of the host building with a minimum fire-resistance rating of 2 hours.

For consistency with the established safe room fire safety strategy of treating the safe room as a protected enclosure, FEMA Funding Criteria specify that the exceptions provided in ICC 500 Section 602 do not apply.

B6.2.4 FIRE EXTINGUISHERS (REFERENCE: ICC 500 SEC 604)

Consistent with ICC 500, fire extinguishers are required on each story of community safe rooms. The spacing and location of fire extinguishers within the safe room and the capacity of each extinguisher are referenced to IBC Section 906 for the normal use of the space. Safe room fire extinguishers should be appropriate for use in a closed environment with human occupancy and surface-mounted

on the safe room wall. In no case should a fire extinguisher cabinet or enclosure be recessed into the interior face of the exterior wall of the safe room unless the exterior wall has been designed to resist the design wind pressure and wind-borne debris impact with the recess present. This is necessary to ensure the integrity of the safe room walls is not compromised by the installation of fire extinguishers.

More Information

Section 4.4, “Emergency Planning and Emergency Supply Kit,” of FEMA P-320 recommends that residential safe rooms be equipped with an ABC-rated fire extinguisher.

ABC refers to fires originating from three types of sources:

A – paper, wood, or fabric

B – gasoline or oil

C – electrical

This page left blank intentionally

Chapter B7 Essential Features and Accessories

This chapter uses Chapter 7 of ICC 500 as the referenced standard and provides background information on criteria to help owners, planners, and design professionals understand the issues. This chapter also includes additional guidance on essential features and accessories based on many years of field observations and investigations related to safe room performance.

Essential features and accessories requirements include protection of critical support systems, exterior weather protection, water closets and lavatories, ventilation, standby power, electrical grounding and bonding, and first aid kits. Drinking water and rainwater drainage are also covered for hurricane safe rooms.

B7.1 Criteria

Safe room essential features and accessories should be designed and constructed in accordance with the provisions of Chapter 7 in ICC 500 as amended by FEMA's Funding Criteria as shown in Table B7-1.

Table B7-1: Comparison of ICC 500 Requirements to FEMA Funding Criteria

ICC 500 Reference	ICC 500 Requirements ^(a)	FEMA Funding Criteria ^(b)
Section 702.5.2. Mechanical ventilation.	Mechanical ventilation. <i>Tornado shelters</i> that rely on mechanical ventilation shall be provided with the minimum mechanical ventilation rate of required outdoor air at a minimum rate of 2.5 cubic feet per minute (0.00118 m ³ /s) per occupant for the <i>design occupant capacity</i> . The mechanical ventilation system shall be connected to a standby power system.	Mechanical ventilation. <i>Tornado safe rooms</i> that rely on mechanical ventilation shall be provided with the minimum mechanical ventilation rate of required outdoor air at a minimum rate of 5 cubic feet per minute (0.00236 m³/s) per occupant for the <i>design occupant capacity</i> . The mechanical ventilation system shall be connected to a standby power system. ^(c) Exception: The minimum mechanical rate of ventilation for tornado safe rooms shall be permitted to be decreased to less than 5 cubic feet per minute per occupant but not less than 2.5 cubic feet per minute per occupant provided the safe room project's mechanical engineer submits a sealed letter with the submittal documents stating the specified minimum mechanical ventilation rate has been analyzed and deemed sufficient to support healthy respiration for the intended population at the design occupant capacity for a minimum of 2 hours.
Section 703.11.5, Location	Location. Standby power supply shall be accessible by a protected access route. The access route shall be located within the <i>hurricane shelter</i> or shall meet the provisions for exterior wall and roof <i>impact protective systems</i> in accordance with this standard.	Location. Standby power supply shall be accessible by a protected access route. The access route shall be located within the community <i>hurricane safe room</i> or shall meet the provisions for exterior wall and roof <i>impact-protective systems</i> in accordance with this standard. ^(d)

Bolded text denotes differences between the ICC 500 Requirement and the FEMA Funding Criteria. Strikethrough text shows requirement from ICC 500-2020 that was removed in ICC 500-2023.

Notes:

- (a) ICC 500 language reprinted here with permission from the International Code Council.
- (b) Table only lists requirements where there are differences between FEMA P-361 and ICC 500 Chapter 7. All ICC 500 Chapter 7 requirements not listed in the table should also be met in their entirety. Safe room types (e.g., community, residential, tornado, hurricane) outside the scope of any given FEMA Funding Criterion need only meet the corresponding ICC 500 criteria (where applicable).
- (c) The noted FEMA Funding Criteria apply to community and residential tornado safe rooms only. FEMA-funded community and residential hurricane safe rooms must comply with ICC 500 Section 703.7 for ventilation (no FEMA Funding Criteria apply).
- (d) The noted FEMA Funding Criteria apply to FEMA-funded hurricane community safe rooms only. There are no ICC 500 requirements for standby power for residential storm shelters or safe rooms and no ICC 500 requirements for the location of standby power for community tornado storm shelters or safe rooms.

B7.2 FEMA Additional Guidance

FEMA offers the following background information and guidance for the criteria referenced in Chapter 7 of ICC 500 or presented as FEMA Funding Criteria in Section B7.1.

B7.2.1 FEMA FUNDING CRITERIA: SAFE ROOM ESSENTIAL FEATURES AND ACCESSORIES

ICC 500-2023 includes two significant changes to Chapter 7 that modify the minimum criteria for storm shelter essential features and accessories. Although the changes will provide an opportunity for communities to lower storm shelter costs, FEMA has decided that in some settings they could result in uncomfortable safe room environments, especially for vulnerable populations. Accordingly, FEMA-funded safe rooms must adhere to the criteria in Table B7-1 for the minimum mechanical ventilation rate in tornado safe rooms and for the protection of standby power access routes in community hurricane safe rooms.

FEMA Funding Criteria for a tornado safe room's minimum mechanical rate of ventilation have been developed primarily to address concerns about safe room occupants' respiratory health, particularly those occupants coping with existing respiratory conditions who may also be suffering from anxiety induced by the tornado and the crowded safe room environment. However, multiple factors such as the volume of air available within the safe room envelope and the demographics of the intended safe room population may be taken into consideration when determining the ideal minimum mechanical ventilation rate needed under standby power conditions. FEMA also recognizes that greater mechanical ventilation rates require more (and/or larger) openings in the safe room envelope, which render the safe room more vulnerable to failure from wind-borne debris impacts especially where IPS are not adequately secured. Accordingly, an exception is provided to allow minimum mechanical ventilation rates between the minimum provided by ICC 500 (2.5 cubic feet per minimum per occupant) and the minimum provided by FEMA (5 cubic feet per minimum per occupant) where analyzed and approved by the safe room project's licensed mechanical engineer.

Another notable change to ICC 500-2023 was the complete removal of the community hurricane storm shelter requirement for protected access routes to standby power (ICC 500-2020 Section 703.7.5; note hurricane shelter standby power requirements have been relocated to Section 703.11 in ICC 500-2023). Although removing the requirement to protect the standby power accessway to the same criteria as the storm shelter will reduce costs and eliminate site design challenges where standby power is located outside the storm shelter envelope, concerns were raised over occupant safety should the standby power require service during the long occupancy durations associated with hurricanes. Upon careful consideration and deliberation, the risks of removing the protected standby power route requirement for FEMA-funded community hurricane safe rooms outweigh the potential cost savings.

B7.2.2 PROTECTION OF CRITICAL SUPPORT SYSTEMS (REFERENCE: ICC 500 SEC 702.2 AND 703.2)

Critical support system protection requirements in ICC 500 correlate with the storm shelter or safe room they serve. Specifically, critical support systems should resist the same design wind pressures, wind-borne debris, and flood hazard as the safe room they serve and should remain functional for at least as long as the minimum period of safe room occupancy for the designated safe room storm type. While hazard resistance is addressed for individual critical support systems throughout this chapter, guidance on the minimum period of safe room occupancy is summarized at the end of this subsection.

As described in Section B6.2.1, although the requirement to protect storm shelter critical support systems was substantially unchanged in Chapter 7 of ICC 500, the definition of “critical support systems” was revised to eliminate “life-safety” (aka, fire protection) systems in the 2020 edition. The 2023 edition further modified the “critical support systems” definition by adding “roof drainage systems” and replacing “potable water and wastewater systems” with “drinking water” and “water closets, lavatories, and sanitation support systems.” The changes in terminology provide better alignment with Chapter 7 requirements.

NOTE

Duration of Critical Support Systems

For funding eligibility of the increased costs associated with extended occupant duration, refer to the applicable program in the *HMA Program and Policy Guide*. Download the most current *HMA Program and Policy Guide* from <https://www.fema.gov/grants/mitigation/hazard-mitigation-assistance-guidance>.

Minimum Period of Safe Room Occupancy

The minimum period of safe room occupancy is an important factor that influences many aspects of safe room design, and it varies depending on the event for which the safe room is designed. Because the FEMA Funding Criteria in Part B of this publication address minimum safe room requirements only, Chapter B7 guidance does not place as much emphasis on optional design features that could be incorporated to increase occupant comfort, particularly when the safe room period of occupancy is expected to exceed the minimum periods described below. For additional considerations on enhanced safe room features and accessories, refer to “Duration of safe room support systems” in Section A3.1.1.

CROSS-REFERENCE

For more information on occupancy density for both tornado and hurricane safe rooms, see Sections B5.2.1 and B5.2.2.

Tornado Safe Rooms

The minimum expected period of tornado safe room occupancy is typically 2 hours, much less than expected for a hurricane safe room. This short timespan allows for fewer provisions to provide occupancy comfort including sanitation, water supply, ventilation, and backup power. However, it is not unusual for tornado safe room occupancy to exceed 2 hours. For example, in the tornado outbreak in the spring of 2011, tornado warnings were occurring throughout the day and many safe rooms were occupied for much longer than 2 hours. **BEST PRACTICE: Consider potentially longer occupancies for some provisions.** In some cases, higher standards related to safe room occupant comfort may even be required by the authority having jurisdiction (e.g., school district).

Hurricane Safe Rooms

Hurricane safe rooms have a 24-hour minimum expected period of occupancy; however, for very slow-moving storms, it could be up to 2 or 3 days.¹¹ For this reason, the occupants of a hurricane safe room need more space and comfort measures than the occupants of a tornado safe room. Refer also to Section A3.1.1 for more information on using a safe room as a post-event recovery shelter.

B7.2.3 WATER CLOSETS AND LAVATORIES (REFERENCE: ICC 500 SEC 702.4 AND 703.4)

ICC 500 specifies the minimum number of water closets and lavatories for community tornado and hurricane safe rooms and also includes references to the IPC as described in the textboxes on this page.

The required number of safe room water closets and lavatories can be met by providing permanent and/or temporary fixtures, such as chemical toilets or other means approved by the authority having jurisdiction. Although portable chemical toilets are permitted, ADA requirements still apply.

Residential safe rooms (tornado and hurricane) serving one- and two-family dwellings are not required to have water closets, but residential safe rooms serving other dwelling types are required to have at least one water closet. Lavatories are not required for residential safe rooms.

Community Tornado Safe Rooms

Tornado safe room owners should install sanitation facilities in accordance with ICC 500 Table 702.3. All community tornado safe rooms are required to have at least one water closet. Where design occupant capacity is greater than 250 but does not exceed 500, a minimum of two water closets are required. For larger community tornado safe rooms, one additional water closet is required for every additional 500 occupants (or portion thereof). For example, a minimum of three water closets would be needed for a community tornado safe room designed to protect from 501 to

¹¹ If the safe room will be used as a recovery shelter after the hurricane passes, the occupancy may be for several days. Additional design and operation considerations for safe rooms that are also used as recovery shelters are beyond the scope of ICC 500 and this publication.

1,000 occupants. Similarly, community tornado safe rooms having more than 50 occupants require at least one lavatory for every 1,000 occupants.

ICC 500-2023 has added new sanitation support method requirements for tornado storm shelters with design occupant capacities of 50 or greater. The provisions mirror those described below for hurricane storm shelters and safe rooms but the required quantity of stored supply water for flushing (1 gallon) and the required capacity for wastewater containment (1.5 gallons) cover 12 occupants instead of one in recognition of the shorter minimum period of shelter occupancy (2 hours versus 24 hours or 1/12). Community tornado safe rooms designed to be occupied for longer than the 2-hour minimum period of occupancy can scale the quantities upward using the same approach. For example, community tornado safe rooms designed for a 4-hour minimum occupation would require at least 1 gallon of supply water and 1.5 gallons wastewater containment capacity for every 6 occupants (4 hours instead of 24 hours or 1/6).

Community Hurricane Safe Rooms

Hurricane safe room owners should install sanitation facilities in accordance with ICC 500 Table 703.3. Because of the long duration of hurricanes, more water closets and lavatories are required in community hurricane safe rooms than community tornado safe rooms when designed to protect 100 or more occupants. Instead of one additional water closet per 500 occupants (or portion thereof), community hurricane safe rooms must provide one additional water closet for every additional 50 occupants. For example, at least two water closets are needed for a hurricane safe room designed to protect 100 occupants, but at least three are needed when it is designed for 101 to 150 occupants. Similarly, one lavatory is required for community hurricane safe rooms designed to accommodate 50 or more occupants, with one additional lavatory required for every 100 occupants.

Hurricane safe rooms are required to include safe room sanitation facilities support methods capable of supplying water and containing waste for the design occupant capacity. For community hurricane safe rooms with design occupant capacities of 50 or greater, ICC 500 has maintained the required per occupant quantities of supply water (1 gallon) for flushing and (1.5 gallons) for wastewater containment in the event that water supply to the safe room is disrupted by the storm. The 1-gallon per occupant supply water requirement for sanitation support is separate from drinking water (see Section B7.2.3); water for sanitation support should be stored within the safe room (e.g., elevated tanks in rest rooms or occupant support areas) or protected by an enclosure designed to the same criteria as the safe room. If the safe room water supply is from a well, then the pump, pump house, and associated equipment need to be protected and have a standby power supply.

Depending on the design occupant capacity of the community hurricane safe room, the minimum capacity to store wastewater can often be addressed through analysis of the sewer pipe capacity between the safe room water closets and the municipal sewer system. The analysis should account for the possibility that the safe room sewer pipes may already be half full when the municipal system fails (e.g., treatment plant power failure). Further, if the safe room is designed or intended for occupations longer than 24 hours, then the supply water and wastewater containment capacity per occupant should be scaled up accordingly, noting that the current minimum quantities for hurricane storm shelters are based on an occupation of 24 hours. Similar to the parallel requirements for

tornado storm shelters, an exception has been provided for hurricane storm shelters to allow the minimum quantity of storage water and the minimum storage capacity for wastewater to be reduced where temporary water closets that do not require water are provided for occupants.

Hurricane Ian MAT Report Recommendation: Potable Water Adjustments for Showers

Recommendation FL-43b. FEMA should consider including guidance and/or commentary in FEMA P-361 on shower facilities. If a shelter allows for the use of showers, shelter managers should consider the showers when planning for interruption of potable water service. This could either be by increasing potable water storage to account for the increased water usage or connecting the showers to a separate and distinct plumbing loop that only services the showers.

B7.2.4 DRINKING WATER (REFERENCE: ICC 500 SEC 703.5)

If a water supply to the safe room is relied upon to meet the drinking water capacity requirements in ICC 500, then the water supply should be protected in the same manner as the water supply for sanitation support as described above. Alternatively, drinking water may be stored within the safe room.

More Information

FEMA guidance concerning food and water storage is available at <https://www.ready.gov/food> and <https://www.ready.gov/water>.

FEMA P-543, *Design Guide for Improving Critical Facility Safety from Flooding and High Winds* (2007), has guidance on continuity of water service for critical facilities and notes that bottled water may suffice for facilities that only need drinking water for occupants.

Tornado Safe Rooms

BEST PRACTICE: Despite the typically short occupancy period for tornado safe rooms, as a best practice, drinking water should be made available as needed for all safe room occupants. In some cases, bottled water may be an economical option.

Hurricane Safe Rooms

Providing safe drinking water in hurricane safe rooms is especially important because of the potentially long periods occupancy. ICC 500 Section 703.4 specifies that at least 1 gallon of drinking water should be provided for each occupant of a hurricane community storm shelter regardless of the design occupant capacity. The same minimum criteria apply to community hurricane safe rooms.

Drinking water storage capacity should be included in the design of the safe room, and water storage and distribution should be addressed in the operations plan for the safe room.

B7.2.5 RAINWATER DRAINAGE (REFERENCE: ICC 500 SEC 703.6)

Rain load requirements for hurricane safe room roofs are addressed in Section B3.2.4.1 along with guidance on usage of the referenced rainfall maps or alternate rainfall data sources. The primary and secondary roof drainage requirements for hurricane safe room roofs that are needed to limit ponding depths within the rain load design conditions are provided in Section 703.5 of ICC 500. The section also includes site drainage requirements for community hurricane safe rooms to prevent site-impounded rainwater from inundating the safe room. Both the roof drainage and site drainage requirements are based on the same rainfall data sources as the rain load requirements.

NOTE**Exterior Weather Protection**

Because of the short duration of tornadoes, enhanced weather protection is not required for tornado safe rooms. ICC 500 Section 703.3 requires exposed C&C assemblies and roof coverings of hurricane storm shelters to be designed to resist rainwater penetration and wind loads associated with the safe room design event. Providing a secondary line of protection, such as roof and wall membranes, is recommended as discussed in FEMA P-424, *Design Guide for Improving School Safety in Earthquakes, Floods, and High Winds* (2010), FEMA P-543, *Design Guide for Improving Critical Facility Safety from Flooding and High Winds* (2007), and FEMA P-577, *Design Guide for Improving Hospital Safety in Earthquakes, Floods, and High Winds* (2007).

B7.2.6 VENTILATION (REFERENCE: ICC 500 SEC 702.5 AND 703.7)

Ventilation criteria for tornado and hurricane safe rooms are specified in ICC 500 Sections 702.5 and 703.7, respectively. Designers have the option of providing natural ventilation (aka passive ventilation) or mechanical ventilation for tornado safe rooms, but all hurricane safe rooms are required to meet ICC 500 natural ventilation requirements. Community hurricane safe rooms with design occupant capacities of 50 or greater must also provide mechanical ventilation. Where required for hurricane storm shelters and safe rooms with design occupant capacities exceeding 50, the minimum mechanical ventilation rate of outdoor air is 5 cubic feet per minute per occupant (cfm/occupant). For tornado storm shelters that rely on mechanical ventilation, ICC 500 reduces the minimum mechanical ventilation rate of outdoor air to 2.5 cfm/occupant. The reduction was driven by the goal of minimizing openings in the storm shelter envelope (to reduce vulnerability to wind-borne debris) and based on an analysis of estimated carbon dioxide concentrations during a typical 2-hour tornado storm shelter occupation. However, as described in Section B7.2.1, FEMA-funded safe rooms must either provide a minimum rate of 5 cfm/occupant for tornado safe rooms that rely on mechanical ventilation or provide a sealed analysis-based approval from the project's mechanical engineer to justify a rate less than 5 cfm/occupant but equal to or greater than 2.5 cfm/occupant. In the first two editions of ICC 500, the storm shelter's mechanical rate of ventilation was deferred to the normal use capacity of the shelter, but observations indicated that systems were often undersized for tornado storm shelters where occupant densities typically exceed normal use. The minimum 5 cfm/occupant rate adopted in the standard for hurricane storm shelters more closely

aligns with the International Mechanical Code® requirements for the population-based ventilation rate in some occupancies.

If the normal-use occupancy mechanical ventilation requirements of the multi-use safe room are greater than the safe room's mechanical ventilation requirements, then the additional load can be provided by an unprotected supplemental system as long as all penetrations of the safe room envelope are protected in accordance with ICC 500 Section 306.4.3. Any equipment needed to meet the minimum safe room mechanical ventilation requirements (including all required components and standby power sources) must still be protected from the safe room design event (see HVAC information below). Alternatively, designers can ensure tornado safe rooms and small hurricane safe rooms comply by sizing and locating ventilation openings to meet ICC 500 natural ventilation criteria. Even if the mechanical system fails during an event when the space is used as a safe room, openings for the mechanical system may provide passive ventilation depending on the system. However, additional openings may be necessary.

Air Conditioning and Heating

Mechanical systems that provide ventilation are typically part of larger systems that also supply air conditioning and heating. However, though heat may be required to prevent water lines from freezing for some safe rooms, air conditioning and heating system designs are not otherwise part of the criteria for safe rooms; therefore, they are not discussed in this publication (or ICC 500). Although air conditioning and heating may increase occupant comfort, they are not necessary for life-safety protection from wind and wind-borne debris.

If any HVAC component is required to meet ventilation requirements of ICC 500 Chapter 7, then those components, their connections, and required standby power sources would be classified as critical support systems (refer to Chapter B2, "Definitions") and should be protected from safe room design event conditions.

Hurricane Ian MAT Report Recommendation: Cooling System Considerations for Shelters

Recommendation 43a (Bullet 2). FEMA should consider revising safe room guidance and grant requirements to consider longer occupancy duration timeframes. Considerations should include:

Connecting the cooling system to the emergency generator or creating an isolated cooling room through which occupants can circulate. When considering longer occupancy durations, providing functioning cooling systems becomes more important. When considering the time of year and the location where hurricanes make landfall, the risk of heat stroke among shelter occupants is a concern.

Continued Operation of Essential Equipment

When a safe room will be constructed in a building that supports medical or other life-critical operations, the designer should consider appropriate design, maintenance, and operations plans to ensure continuous operation of all critical mechanical and electrical equipment during and after a

tornado or hurricane. Failure of the critical equipment in these buildings can have a severe effect on continuity of operations.

B7.2.7 STANDBY POWER (REFERENCE: ICC 500 SEC 702.9 AND 703.11)

A standby power system is essential for safe rooms during an extreme wind event because the primary power source is often disrupted. In accordance with ICC 500, safe room standby power systems are required to have sufficient capacity to supply systems and circuits needed for standby lighting and mechanical ventilation (where needed to meet ventilation criteria) at the same time continuously for the minimum period of occupancy (i.e., 24 hours for hurricane, 2 hours for tornado). Safe rooms used by specific occupant groups may have user-specific needs for additional standby power that are not addressed in ICC 500. For example, safe rooms in hospitals and other residential care facilities will need additional standby power to maintain operation of essential medical equipment. More common examples would include additional capacity to charge equipment, including occupant's cell phones during a hurricane, or to maintain operations for longer than the minimum expected period of occupancy.

Power and Lighting Terminology

Criteria for “emergency” power and lighting are distinguished from “standby” power and lighting criteria in ICC 500, the IFC, and Chapter 27 of the IBC. In addition to different installation requirements (see IBC Section 2702.1.3), they have fundamentally different functions as provided in IBC Section 2702.1.4, “Load Transfer.” In short, emergency power is required to turn on emergency lighting within 10 seconds of primary power loss to facilitate immediate evacuation. Conversely, standby power enables designated critical support systems to continue to operate after a building has lost power and is required to activate within 60 seconds of primary power loss.

Hurricane Ian MAT Report Recommendations: Standby Power

Recommendation 43a (Bullets 1 and 3). FEMA should consider revising safe room guidance and grant requirements to consider longer occupancy duration timeframes. Considerations should include:

- **Increasing fuel storage capacity and requiring an emergency generator “quick connect”** to enable redundant capability to ensure the safe room can operate for an increased duration as needed.
- **Providing many more electrical receptacles for occupants.** Occupants have a far greater reliance on technology for communication now, than in the past. Furthermore, these shelter receptacles should either be wired in advance, or be able to be connected to emergency generators with the capacity to provide power for a longer shelter occupancy duration than 24 hours.

The standby power system and all associated components essential to operating the system are required to be protected from the safe room design event conditions as described in Section B7.2.1. Associated components may include fuel supply, transfer switch, distribution panel, and cabling between the generator and safe room. Such protection is especially important if the generator is not located adjacent to the safe room and connections will be exposed to hazard conditions between the generator and the safe room. Exposed components are less likely for hurricane safe rooms because their power supply is required to either be accessed by a protected route or located within the safe room occupant support area. Although the requirement for protected accessway between the community hurricane storm shelter and the shelter's required standby power was removed from ICC 500-2023, FEMA maintains the requirement for FEMA-funded community hurricane safe rooms as described in Section B7.2.1.

Where safe room power demand is low, a battery-powered system is recommended as the standby power supply because it can be located, and fully protected, within the safe room with relative ease. For hurricane safe rooms, a more significant standby power supply (i.e., generator) will likely be needed to meet demand.

More Information

Generators usually should not be placed underground because of maintenance access, exhaust, and cooling considerations as well as the potential for flooding.

Extensive flood damage to equipment located in sub-grade portions of buildings was observed by the FEMA MAT after Hurricane Sandy (see Section 4.1.3, "Critical Building Systems," of FEMA P-942, *Mitigation Assessment Team Report: Hurricane Sandy in New Jersey and New York* [2013]).

B7.2.8 STANDBY LIGHTING (REFERENCE: ICC 500 SEC 702.8 AND 703.10)

As described in the "Power and Lighting Terminology" textbox in the previous section, the IBC requires emergency lighting to facilitate evacuation when primary power is disrupted. Chapter 7 of ICC 500 now references the IBC for exit signs and emergency lighting requirements. Standby lighting specifications in ICC 500 align with legacy FEMA guidance and are based on the same minimum level of illumination—1 foot-candle measured at floor level—as IBC requirements for general means of egress lighting in occupied spaces, but for longer durations, and not just along paths of egress. Specifically, standby lighting for community storm shelters and safe rooms is required to provide illumination for the minimum storm-type period of occupancy (i.e., 24 hours for hurricane, 2 hours for tornado) across all areas designated for shelter occupation and support. Flashlights or equivalent lighting devices such as chemical light sticks (where approved) are useful as a secondary lighting provision when stored within the safe room and regularly maintained (see Section A4.4.3); however, except for small community safe rooms (design occupant capacities of less than 50), they cannot be used to satisfy standby lighting requirements.

CODES AND STANDARDS

For applicable code provisions on emergency lighting and exit signs, refer to IBC Chapter 10, “Means of egress,” with special reference to Section 1008, “Means of egress illumination,” and 1013, “Exit signs.”

A reliable lighting system in a community safe room will enable safe room operations and help calm safe room occupants during an extreme wind incident. Failing to provide proper illumination in a safe room may make it difficult for the owners/operators to minimize the agitation and stress of the safe room occupants during the event.

CODES AND STANDARDS

Grounding and bonding of storm shelters and safe rooms is addressed in Sections 702.6 and 703.8 of ICC 500. Exposed metal surfaces within the safe room are required to be electrically bonded and grounded where required by Article 250 of NFPA 70, National Electric Code, or by the authority having jurisdiction.

B7.2.9 FIRST AID KITS (REFERENCE: ICC 500 SEC 702.10 AND 703.12)

All safe rooms should be prepared to treat injured occupants. ICC 500 requires first aid kits in all community tornado and hurricane storm shelters, which is consistent with FEMA guidance. An exception is provided for hurricane storm shelters (and safe rooms) where equivalent supplies are kept within the shelter because some shelters are staffed with healthcare personnel (e.g., emergency medical technicians) who are charged with maintaining dedicated healthcare supplies and bringing them onsite during activation. The exception does not extend to tornado shelters because shorter warning periods may not afford time to gather supplies.

Standardization of first aid kits is addressed by requiring minimum compliance with “Class A” first aid kits as listed in ANSI/ISEA Z308.1, American National Standard, *Minimum Requirements for Workplace First Aid Kits and Supplies*. Many commercially available kits reference the standard. Although the standard does not rate kits according to the number of persons in the workplace (or shelter/safe room), Class A kits are intended to “provide a basic range of products to deal with most common types of injuries encountered in the workplace including major wounds, minor wounds (cuts and abrasions), minor burns and eye injuries” (ANSI/ISEA, 2015).

Individual safe room operators should assess the appropriateness of first aid kit supplies based on their safe room’s design occupant capacity and intended occupants (if known). For example, large safe rooms should consider having more than one Class A first aid kit, or a Class B kit, which is “intended to provide broader range and quantity of supplies to deal with injuries encountered in more populated, complex and/or high-risk workplace environments” (ANSI/ISEA, 2015). All standard-

approved kits are required to be labeled to indicate contents. In addition to providing product verification for the owner/operator, authority having jurisdiction, or FEMA grant personnel, the label inventory list can serve to facilitate maintenance of the contents during regularly scheduled checks as recommended in Section A4.4.3.

FEMA strongly recommends first aid kits for residential safe rooms as well. Guidance on contents for residential safe room first aid kits and other recommended supplies is provided in Section 6.2 of FEMA P-320.

This page left blank intentionally

Chapter B8 Test Methods for Impact and Pressure Testing

This chapter uses Chapter 8 of ICC 500 as the referenced standard and includes FEMA guidance based on many years of field observations and investigations related to safe room performance.

B8.1 Criteria

Impact and pressure testing should be conducted in accordance with the provisions of Chapter 8 in ICC 500. FEMA does not recommend any additional criteria.

B8.2 FEMA Additional Guidance

This chapter provides background on wind-borne debris, its effects on buildings, and the representative test missiles used for tornado and hurricane safe room impact testing. It also provides direction on testing safe room assemblies and components to resist the impact and wind pressures outlined in Section B3.1 using the test procedures specified in ICC 500 Chapter 8.

B8.2.1 WIND-BORNE DEBRIS IN TORNADOES AND HURRICANES

The quantity, size, and force of wind-borne debris generated by tornadoes and hurricanes are unequaled by those generated in other windstorms. Wind-borne debris can breach the building envelope, potentially leading to increased pressures on structural systems; worse yet, it can injure or kill building occupants. In the design of community safe rooms, wind pressures are likely to govern the structural design, including the exterior wall and roof assemblies. Consequently, after the safe room has been designed or tested to withstand wind pressures, the proposed wall and roof assemblies, as well as impact-protective systems, should be evaluated for impact resistance from missiles.

Wind-borne debris can be classified by size. Table B8-1 presents examples of small, medium, and large wind-borne debris and describes typical damage they inflict on buildings not designed as safe rooms. Figure B8-1 and Figure B8-2 show examples of medium debris; Figure B8-3 through Figure B8-7 show examples of large debris.

Table B8-1: Wind-Borne Debris Classifications for Tornadoes and Hurricanes

Debris Size	Typical Debris	Observed Damage
Small (Light Weight)	Roof aggregate, roof shingles, tree limbs, pieces of wood framing members, bricks	Broken glazing and punctured roof coverings

Debris Size	Typical Debris	Observed Damage
Medium (Medium Weight)	Appliances, HVAC units, long wood framing members, wood sheathing, steel decking, pieces of roof coverings, furniture	Breached doors, punctures through wall and roof assemblies
Large (Heavy Weight)	Structural columns, beams, joists, roof trusses, precast concrete panels, large tanks, vehicles, trees	Punctures/crushing of wall and roof assemblies, spalling from the interior side of concrete and CMU walls and concrete roofs

HVAC = heating, ventilation, and air-conditioning
 CMU = concrete masonry units



SOURCE: FEMA P-424

Figure B8-1: Medium debris: Pieces of a built-up roof from Hurricane Katrina (MS, 2005)

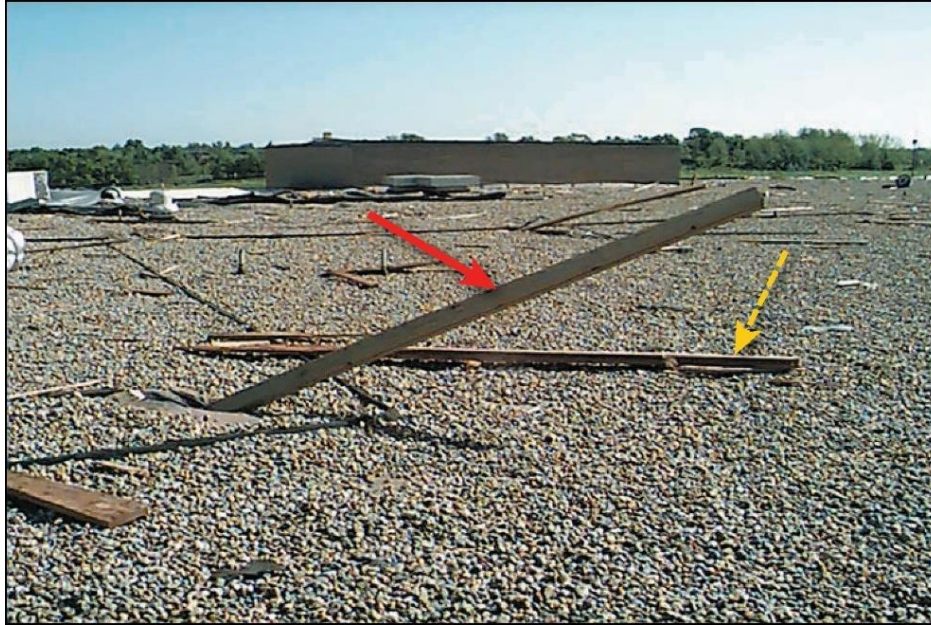

SOURCE: FEMA 342

Figure B8-2: Medium debris: The double 2x6 framing member (red arrow) sticking 13 feet out of the roof penetrated a ballasted ethylene propylene diene monomer (EPDM) roof membrane, 3 inches of polyisocyanurate insulation, and a steel roof deck. The yellow dashed arrow indicates a 16-foot-long 2x10. (Moore, Oklahoma, 1999 tornado)

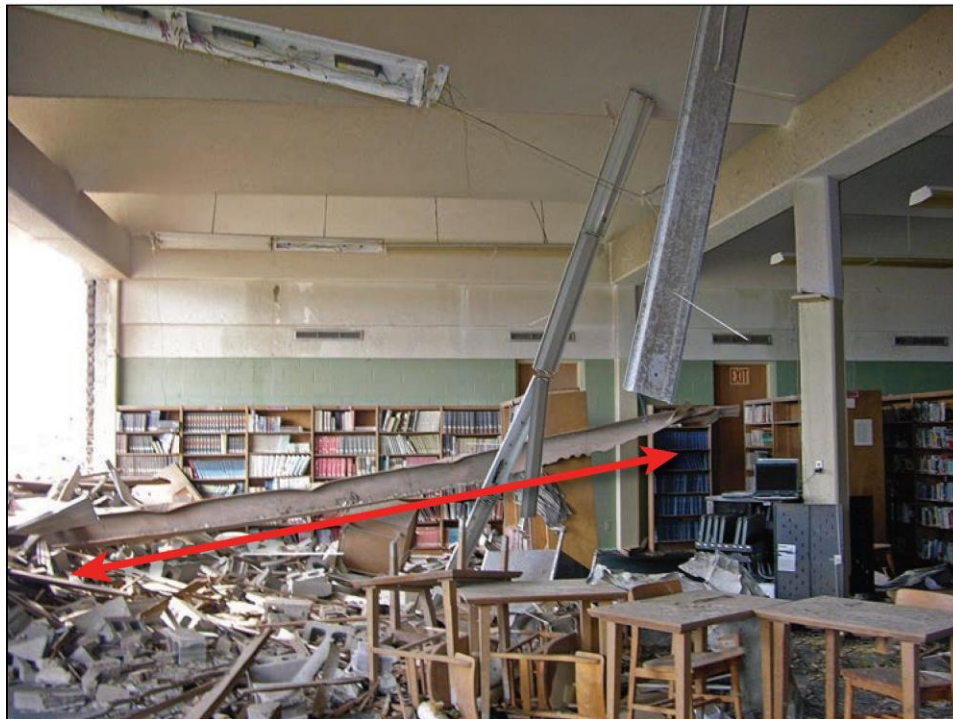

Figure B8-3: Large debris: Steel beam that blew into a school (Greensburg, Kansas, 2007 tornado)



SOURCE: FEMA P-424

Figure B8-4: Large debris: Steel roof trusses that blew off a school (U.S. Virgin Islands, 1995 Hurricane Marilyn)

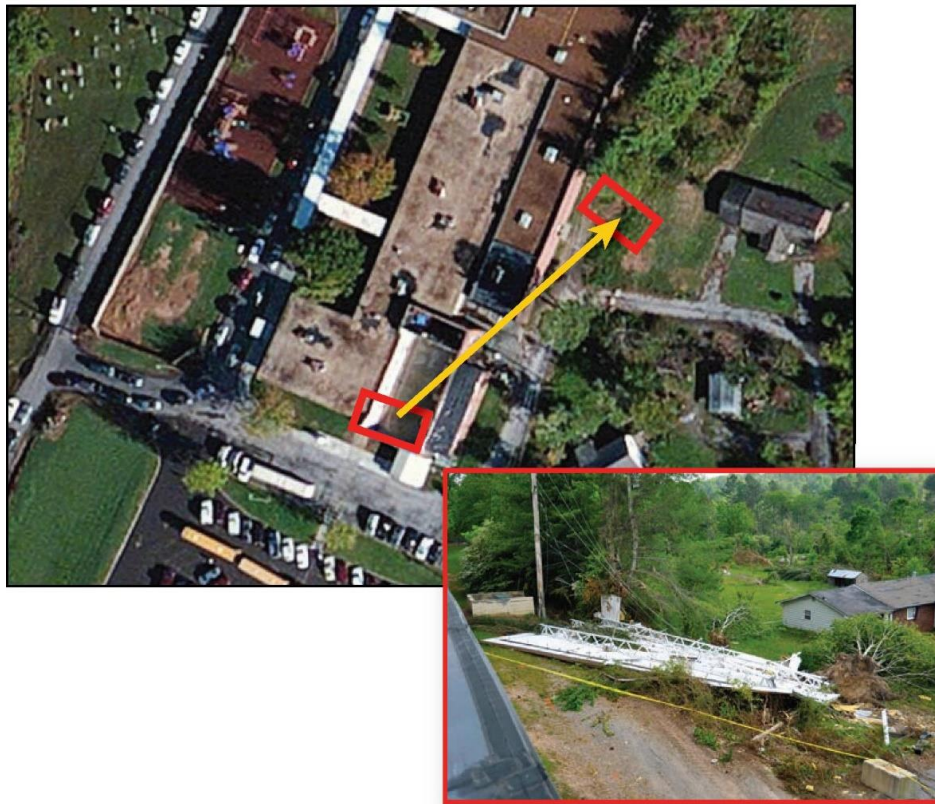

Figure B8-5: Large debris: An EF1 tornado blew a school gymnasium's steel truss and steel deck roof assembly approximately 230 feet (Cleveland, Tennessee, 2011)



Figure B8-6: Large debris: Propane tank that was blown from its original location (Midwest tornadoes, 2007)



Figure B8-7: Large debris: A school bus was lifted atop a school (Caledonia, Mississippi, tornado, 2008)

Debris Potential at Safe Room Sites

Debris impacting buildings during tornadoes and hurricanes can originate from the building itself (Figure B8-1, Figure B8-4, and Figure B8-5). As buildings break apart, roof and wall coverings are typically the first elements to fail. However, failure sometimes initiates when the roof structure is compromised. With loss of the roof structure or roof decking, exterior walls often collapse. During violent tornadoes, failure progresses until many or all of the interior walls also collapse. Debris can also originate from the surrounding area (Figure B8-2, Figure B8-6, and Figure B8-7).

During safe room design development, the RDP should review the site vicinity to assess potential wind-borne debris sources and laydown or falling debris hazards (as discussed in Section B3.2.6.5). In urban, suburban, and forested rural areas, the designer should assume that small and medium wind-borne debris (as classified in Table B8-1) will likely occur in the vicinity of the safe room. Figure B8-8 illustrates the quantity, size, and type of wind-borne debris that is often generated by a strong or violent tornado in urban and suburban areas. If a site-specific analysis identifies the potential for exceptionally large debris, the designer should consider adjusting the location of the proposed safe room or further strengthening the safe room.



SOURCE: FEMA P-577

Figure B8-8: Representative quantity, size, and type of debris that is often generated by a strong or violent tornado. The building damage at this site was indicative of an EF3 tornado. (Greensburg, Kansas, 2007)

B8.2.2 REPRESENTATIVE MISSILES FOR DEBRIS IMPACT TESTING

The trajectories of various wind-borne debris have been the subject of research at numerous universities, including TTU, University of Florida, Louisiana State University, and the University of Western Ontario.¹² As part of this work, debris was categorized by its shape and flight characteristics into “compact,” “rod,” and “plate/sheet” types. Compact objects, usually generalized as cubes or

¹² This research includes James R. McDonald, *Rationale for Wind-Borne Missile Criteria for DOE Facilities*, Institute for Disaster Research, Texas Tech University, September 1999; Bahareh Kordi, Gabriel Traczuk, and Gregory A. Kopp, “Effects of wind direction on the flight trajectories of roof sheathing panels under high winds,” *Wind and Structures*, Vol. 13, No. 2, 2010, pp. 145–167; and Bahareh Kordi and Gregory A. Kopp, “Effects of initial conditions on the flight of wind-borne plate debris,” *Journal of Wind Engineering and Industrial Aerodynamics*, 2011, pp. 601–614.

spheres, are driven by wind drag forces; they have downward-directed trajectories from their initial point of flight and often hit the ground before hitting a downwind building. On the other hand, the rod and plate types are subjected to significant lift forces and can fly up before eventually attaining a downward trajectory under the influence of gravity. Therefore, the rod and plate types have more potential to stay in flight and accelerate to damaging horizontal speeds before impacting a downwind building. These characteristics are consistent with the observed wind-borne debris distances traveled and damage observed after tornadoes and hurricanes.

A nominal 2x4 (a common building material) was chosen as the test missile for much of the early research that modeled wind-borne debris effects on buildings. This test missile was selected based on numerous tornado and hurricane investigations, which found that much of the wind-borne debris consisted of wood framing members that came from buildings that were torn apart by wind-induced pressures and associated forces. The 2x4 was selected as the test missile to represent a variety of damaging plate/sheet and rod type objects that have been commonly observed during tornado and hurricane investigations. These objects include roof tile, roof sheathing and decking, and metal roof panels, as well as wood studs, joists, and rafters. The end-on impact of a 2x4 traveling at high velocity, with its relatively small impact surface, represents one of the most serious threats for penetration of a protective barrier by common building materials. As such, the 2x4 has greater potential to perforate wall and roof assemblies than many other common types of debris. In considering the potential perforation of a safe room's roof and wall assemblies, as well as impact-protective systems, the designer should assume worst-case test conditions (i.e., blunt [square-faced] boards striking perpendicular to the test surface).¹³

Although large pieces of wind-borne debris are often found in the aftermath of tornadoes and hurricanes (Figure B8-9 shows penetration of a refrigerator caused by a 2x6), heavy pieces of debris that become airborne are not likely to be carried at speeds as fast as the test missile. Therefore, if large missiles become airborne, they are less likely than the test missile to perforate a safe room unless sheathing materials that provide additional sail area for wind to propel the object remain attached. However, laydown of very large towers (Figure B3-14) or collapse impact of exceptionally large debris may allow debris to enter the safe room (see Section B3.2.6.5).

¹³ Testing at TTU determined that blunt (square faced) boards are more likely than pointed ones to perforate building assemblies.



SOURCE: FEMA 342

Figure B8-9: Refrigerator pierced by a 2x6. The portion of the 2x6 that is visible was 4 feet 8 inches long. It went several inches into the freezer compartment. (Oklahoma City, Oklahoma, 1999 tornado)

Tornado Test Missile Weight

Following the Oklahoma and Kansas tornado outbreaks of May 3, 1999, both FEMA and TTU investigated the tornado damage and debris fields and concluded that the 15-pound 2x4 test missile was reasonable for tornado safe room design (FEMA 342, *Midwest Tornadoes of May 3, 1999: Observations, Recommendations, and Technical Guidance* [1999]). ICC 500 has further standardized the tornado impact test missile as described in the “Codes and Standards” textbox on the following page. Note that the complex interactions between barrier and missile that occur during high-speed impact require that a number of test missile characteristics be controlled in order to provide reliable repeatable measure of barrier performance.

Hurricane Test Missile

None of the U.S. building codes or ASCE 7 addressed wind-borne debris at the time Hurricane Andrew struck South Florida in 1992. In the aftermath of that event, the 1994 edition of the South Florida Building Code adopted wind-borne debris requirements to protect exterior glazing to minimize building damage from development of high internal pressure. Although the importance of glazing resistance to wind-borne debris had long been known, prior to Hurricane Andrew, building code officials were not receptive to adding glazing protection requirements to the model codes.

The 1995 edition of ASCE 7 incorporated very basic wind-borne debris requirements for portions of hurricane-prone regions. ASTM E1996,¹⁴ first published in 1999, has been referenced in ASCE 7 since the 2002 edition and provides specifications for hurricane test missiles, including a cluster of steel balls (representing small roof aggregate) and 2x4s of various masses and test speeds. The 9-pound 2x4 is the heaviest test missile specified in ASTM E1996. The 2000 edition of the IBC was the first U.S. model building code to adopt wind-borne debris provisions through reference to ASTM E1996.

NOTE

DESIGN TEST MISSILES

The first use of the 9-pound 2x4 as a design (test) missile dates back to 1975 in *Darwin Area Building Manual* (Darwin Reconstruction Commission, 1975). This building code provision was in response to the devastation caused in Australia by Tropical Cyclone Tracy in 1974.

CODES AND STANDARDS

ICC 500 Section 803.4, includes specifications on test missile wood species, grade, and tolerances to limit defects and warping. Additional tolerances apply to weight (+/- 0.25 lbs.) and length (between 10 and 15 feet for tornado missile and 6 and 10 feet for hurricane missile).

The wind-borne debris requirements in ASCE 7 and IBC were developed and promulgated to minimize building damage. Although occupant safety is factored into their reliability analyses, their performance objectives are based on much shorter event recurrence intervals than are applied for storm shelters and safe rooms. Hence, because safe rooms are intended to provide near-absolute protection, the missile impact criteria are much more stringent than the impact criteria for other types of buildings. The hurricane safe room test missile is the same as the large test missile referenced in ASTM E1996 (i.e., 9-pound 2x4); however, the safe room test missile has a much higher impact test speed.¹⁵

Impact Test Missile Speeds

For a 250 mph tornado speed (the highest safe room design wind speed), the horizontal speed of a 15-pound 2x4 test missile is calculated to be 100 mph based on a simulation program developed at TTU. The vertical speed of a falling 2x4 is considered to be two-thirds the horizontal missile speed, or 67 mph when the horizontal speed is 100 mph.

¹⁴ ASTM E1996 is ASTM International's (ASTM's) Standard Specification for Performance of Exterior Windows, Curtain Walls, Doors, and Impact Protective Systems Impacted by Windborne Debris in Hurricanes.

¹⁵ The highest impact velocity for the 9-pound 2x4 missile in ASTM E1996 is approximately 55 mph; for hurricane safe rooms, test missile impact speeds range from 80 mph to 118 mph.

The horizontal speeds of all types of wind-borne debris increase progressively with distance traveled and duration of flight because the horizontal wind forces continue to act in the direction of the wind until the debris speed reaches the wind speed. However, the debris invariably strikes the ground or a building well before this speed is reached. Thus, the horizontal speed at which a given piece of debris strikes a building depends on several factors: the gust wind or tornado speed at the time of release (most debris flight durations are less than 3 seconds), the weight and shape of the debris, the initial angle at release, and the distance it travels before impact.

Chapter B3 provides impact test speeds for tornado and hurricane safe room test missiles. The speeds at which the test missiles are propelled are correlated to the safe room design wind or tornado speed at a given site. For tornadoes, the horizontal test missile speed ranges from 80 to 100 mph. This range equals about 0.4 to 0.6 times the safe room design wind speed. For hurricanes, the horizontal test missile speed ranges from 80 to 118 mph. This range equals 0.5 times the safe room design wind speed.

The paper titled “Trajectories of Wind-Borne Debris in Horizontal Winds and Applications to Impact Testing” (Lin et al., 2007) was considered specifically in determining an appropriate factor to be applied to the hurricane safe room design wind speed to generate the hurricane horizontal test missile speed. The Lin paper demonstrated that a 2x4 test missile will reach 0.4 times the wind speed after approximately 16 feet (5 meters) of horizontal displacement and will reach 0.5 times the wind speed after approximately 33 feet (10 meters) of horizontal displacement. The vertical distance traveled by the debris is irrelevant to this consideration beyond affecting the horizontal displacement (a greater amount of lift for an object typically results in greater horizontal displacement). While the Lin paper finds more research on the mechanics and aerodynamics of wind-borne debris is necessary, it concludes that the speed achieved by wind-borne debris is a function of the horizontal displacement and wind speed.

Based on findings from FEMA MAT reports, hurricanes can easily produce rod-like wind-borne debris that travels beyond 16 feet and, therefore, exceeds 0.4 times the wind speed. Based on numerous recorded observations of horizontal displacement in the range of 16 to 33 feet, the 0.5 factor was selected for use by FEMA and was later adopted by ICC 500. Figure B8-10 shows an example of wind-borne debris determined to have traveled in excess of 30 feet.



SOURCE: FEMA P-488

Figure B8-10: Impact of structural wood members in the gable end from a neighboring house (Pine Island, Florida)

B8.2.3 PERFORMANCE OF WALL AND ROOF ASSEMBLIES DURING TORNADO MISSILE IMPACT TESTS

Wall and roof assemblies must be tested to evaluate impact resistance because there is no adequate method to model the impact-induced complex interactions of wall components. The test assembly must accurately replicate the proposed wall assembly design (including the same type, size, and thickness of materials; same type, size, and spacing of fasteners; and configuration [arrangement] of all components). Figure B8-11 illustrates impact locations required by ICC 500 Section 803 for a roof or wall assembly that has panel joints.

To provide an understanding of what type of assemblies have performed well, this section presents a summary of information on assemblies composed of common materials that have successfully passed the largest and fastest tornado test missile (i.e., the 15-pound 2x4 traveling horizontally at 100 mph) specified in Chapter B3.

Safe room and storm shelter designers rely on test results from previous missile impact tests to specify impact resistant wall and roof assemblies. Currently, the most comprehensive compilation of applicable test reports is included in *A Summary Report on Debris Impact Resistance of Building Assemblies* (TTU, Florida A&M University, Florida State University, and University of Florida, 2006), which is available through the link provided under “Wall Sections that Passed Previous Missile Impact Tests” on the safe room website at <https://www.fema.gov/emergency-managers/risk-management/building-science/safe-rooms/resources>. Unfortunately, the test results included in the report predate the ICC 500, and therefore do not necessarily comply with the testing criteria specified for roof and wall assemblies through ICC 500 Section 306.3. FEMA recognizes the need for

retesting non-proprietary roof and wall assemblies to demonstrate compliance with ICC 500 through cooperation with certified testing laboratories and the industry groups representing the materials described in this section.

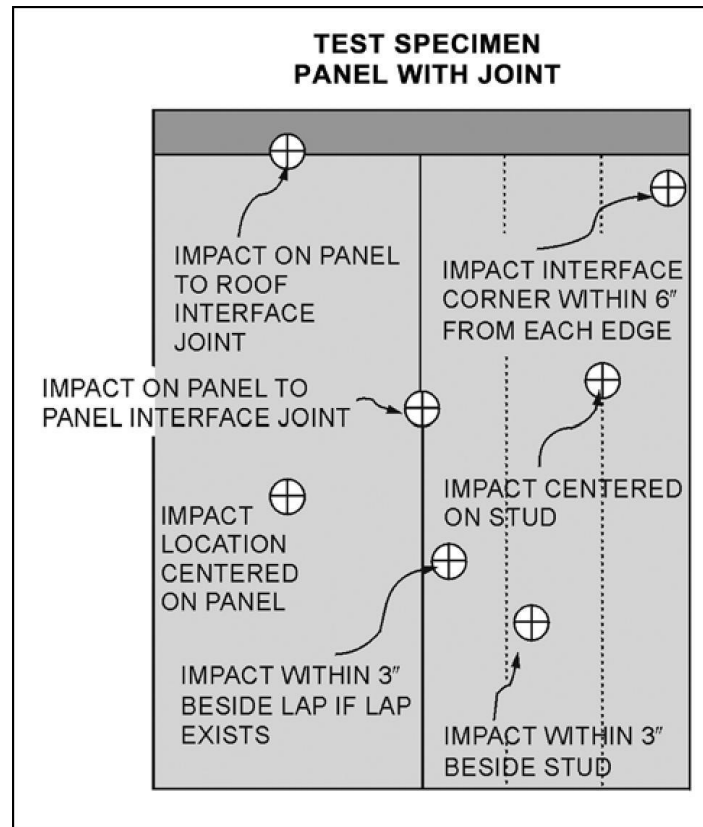

SOURCE: ICC 500 FIGURE 803.9.2(2); USED WITH PERMISSION

Figure B8-11: Impact test locations for a panel or framed roof or wall assembly

See Section B8.2.4 regarding openings in the safe room envelope.

NOTE

Rigorous Testing

Tests have shown that missiles that impact some wall assemblies next to a stud can cause perforation, while impacting midway between studs results in permanent deformations but not perforation. Testing has also shown that joints between wall assembly components are sometimes the weak link in the assembly. To ensure that potential wall assembly vulnerabilities are discovered during impact testing, Section B3.2.6 refers to the impact testing requirements in ICC 500 Section 803. The Section 803 test protocol includes criteria pertaining to the impact test apparatus, calibration, impact procedure, test missile properties and speed, test temperature, impact angle, impact locations, number of impacts, pass/fail criteria, and reporting. Figure B8-11 illustrates impact locations for a roof or wall assembly that has panel joints.

B8.2.3.1 Impact Resistance of Wood Wall Assemblies

TTU conducted extensive testing of wall assemblies that use plywood sheathing. The most effective designs, in terms of limiting the number of layers of plywood necessary, incorporate masonry infill of the wall cavities or integration of 14-gauge steel panels as the final layer in the assembly.

For conventional light-frame construction, the side of the wall where the sheathing or protective material is attached and the method of attachment can affect the performance of the wall in resisting wind-borne debris. The impact of debris on wall components attached to the exterior side of a wall pushes the material against the wall studs. Wall components attached to the inside of the wall (i.e., interior side of the safe room) can be knocked loose from the studs and pushed into the safe room interior if the components are not adequately attached to the studs. Additionally, wall components on the exterior of the wall are susceptible to being pulled off the studs by wind suction pressures if the wall components are not adequately attached to the studs.

Consequently, sheathing materials should be securely attached to the framing members. Tests have shown that sheathing attached using wood adhesive complying with ASTM D3498 and code-approved #8 screws (not drywall screws) penetrating at least 1¹/₂ inches into the framing members and spaced not more than 6 inches on center provides sufficient capacity to withstand the tornado design wind loads if the sheathing is attached to the exterior surface of the wall studs. These criteria are also sufficient to keep the sheathing attached when struck by the tornado test missile when the sheathing is attached to the interior surface of the studs.

B8.2.3.2 Impact Resistance of Wall Assemblies with Steel Sheathing

TTU tested wood-frame wall assemblies that incorporate various gauges of cold-rolled ASTM A569 and A570¹⁶ Grade 33 steel sheets. When properly configured, the steel sheathing stops the test missile by deflecting and spreading the impact load to other wall assembly components. When improperly configured, the wall assembly can be perforated, as illustrated by the following test results:

- When the steel is 14 gauge or lighter and backed by a substrate that prevents deflection of the steel, the test missile perforates the steel.
- When 14-gauge or lighter steel sheets are placed between plywood layers, the test missile perforates the steel because the steel does not have the ability to deflect.

Refer to Figure B8-12 for two examples of wood-frame wall assemblies with steel sheathing that have passed previous safe room missile impact testing. Prescriptive wood-frame solutions for residential safe rooms (including wall assemblies with 14-gauge steel sheathing) are available in FEMA P-320.

¹⁶ ASTM A569 and A570 were withdrawn and replaced by ASTM A1011 in 2000.

TTU found that 12-gauge or heavier steel sheets always pass the tornado missile impact test. Test configurations included 12-gauge steel directly over studs and the steel sheet mounted over plywood. Test samples used the standard stud spacing of 16 inches on center. Wider stud spacing affects the permanent deformation of the steel sheet. Permanent deformation of 3 inches or more into the safe room is deemed unacceptable.

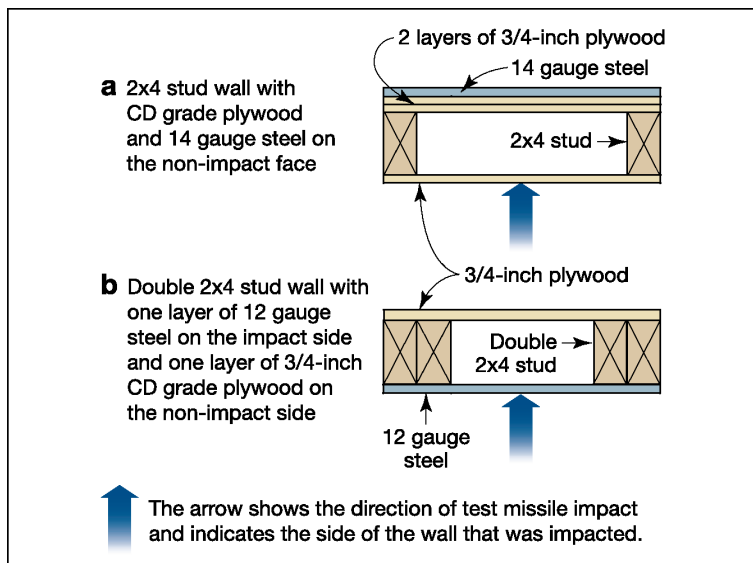

Figure B8-12: Use of steel sheet metal in wall assemblies

B8.2.3.3 Impact Resistance of Concrete Masonry Unit Wall Assemblies

TTU found that 6-inch concrete masonry unit (CMU) walls that are fully grouted with ASTM C476 grout and reinforced with #4 rebar at 36 inches on center, and 8-inch CMU walls that are fully grouted and reinforced with #5 rebar at 48 inches on center, can withstand the tornado test missile (Figure B8-13). However, more reinforcing steel may be required to resist wind loads.

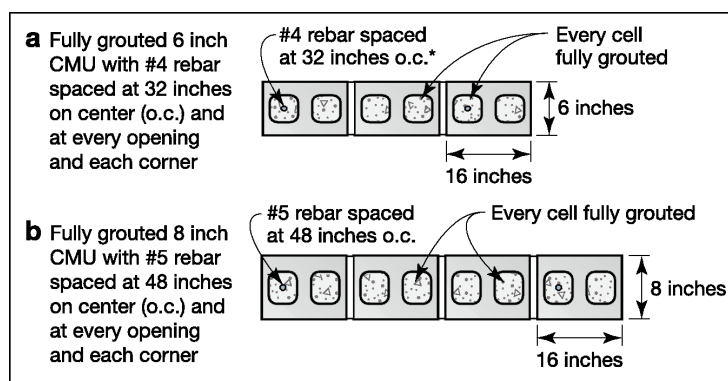

Figure B8-13: CMU wall assemblies

B8.2.3.4 Impact Resistance of Reinforced Concrete Wall and Roof Assemblies

Research related to the design of nuclear power facilities has produced a relatively large body of information and design guides for predicting the response of reinforced concrete walls and roofs to

the impact of wind-borne debris.¹⁷ The failure modes have been identified as penetration, spalling, barrier perforation, and complete debris perforation, as described in the text box.

The design of reinforced concrete walls for wind-borne debris impact protection should focus on establishing the minimum wall thickness to prevent threshold spalling under the design (test) missile impact. Wall designs should be validated by impact testing per ICC 500 Section 803; pass/fail criteria are provided in Section 803.10.

Twisdale and Dunn (1981) have published some of the design equations developed for nuclear power plant safety analysis. Steel pipes and rods were the design (test) missiles used to develop the analytical models for the nuclear industry. The nuclear industry models are expected to generate conservative estimates of performance for softer wind-borne debris, such as a wood structural member, impacting a wall. However, at some sites, wind-borne debris may include steel joists, beams, or pipe columns (Figure B8-14 and Figure B8-15).

TERMINOLOGY

Penetration: When wind-borne debris penetrates into, but not completely through, the wall assembly. This condition is of no consequence unless it creates spalling.

Spalling: When concrete is ejected into the safe room. Spalling occurs when the shock wave produced by the impact creates tensile stresses in the concrete on the interior surface that are large enough to cause a segment of concrete to burst away from the wall. Threshold spalling is when spalling is just being initiated and is usually characterized by small fragments of concrete being ejected. When threshold spalling occurs, a person struck by the spall debris might be injured but is not likely to be killed. However, as the size of the spall increases, so does the velocity with which it is ejected from the wall or roof. A person struck by large spall debris will likely be injured and possibly die, particularly if the spall falls from high up on a wall or the roof. ICC 500 pass/fail criteria for spalling employs a witness screen on the interior side of the storm shelter wall (or roof section) to determine whether or not test missile-induced spalling could potentially endanger occupants.

Barrier perforation: When wind-borne debris creates a hole through the wall (the debris may bounce off the wall or it may become stuck in the hole). A plug of concrete about the diameter of the impacting debris is knocked into the safe room. The plug can cause injury or death.

Complete debris perforation: When the wind-borne debris itself enters the safe room. The debris or dislodged wall fragments can cause injury or death.

Source: Twisdale and Dunn (1981)

¹⁷ For example, James R. McDonald, *Rationale for Wind-Borne Missile Criteria for DOE Facilities*, Institute for Disaster Research, TTU, September 1999.



Figure B8-14: Steel porch column debris from an apartment complex where columns that were 7 feet 9 inches long and 4¼ inches in diameter (see red arrows) had a significant upward trajectory and flew approximately 230 feet (Tuscaloosa, Alabama, 2011 tornado)



Figure B8-15: Steel beam debris (Greensburg, Kansas, 2007 tornado)

Test results from a number of investigations (Twisdale and Dunn, 1981) suggest that 6-inch-thick reinforced concrete walls are needed to stop a 15-pound wood 2x4 test missile impacting at 100 mph without threshold spalling. TTU research indicates that a 6-inch reinforced concrete wall (Figure B8-16, illustrations [a] and [b]) can resist this test missile). Reinforced concrete walls constructed with insulating concrete forms (ICFs) with a uniform concrete section at least 4 inches thick (Figure B8-16, illustration [b]) can also provide sufficient protection.

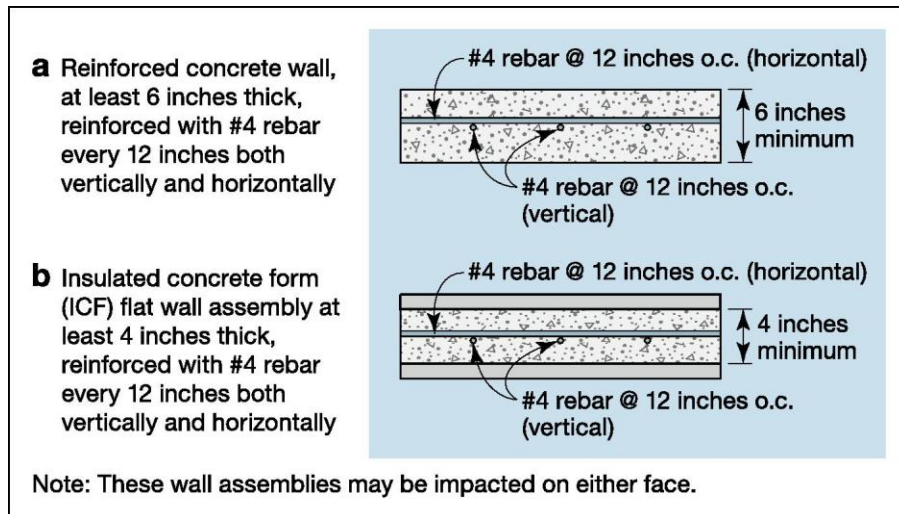

Figure B8-16: Reinforced concrete wall [a] and reinforced concrete “flat” wall constructed with ICFs [b]

When using ICF, the wall design and construction must not have discontinuities that would allow wind-borne debris to enter the safe room. Figure B8-17 shows an ICF waffle grid wall of an occupied “tornado shelter” that was perforated when struck by a tornado. Two pieces of metal tube debris perforated the wall (i.e., the tubes extended into the interior of the room); as visible in the photograph, the wall had numerous air voids that weakened the section’s resistance to wind-borne debris. Based on these observations, the wall assembly did not comply with FEMA P-361 or ICC 500. Extreme care should be taken when vibrating concrete for all reinforced concrete wall types and for mortar used with masonry walls to ensure proper consolidation and elimination of voids.



SOURCE: FEMA P-1020

Figure B8-17: Red arrows show a steel tube that perforated a waffle grid ICF wall. Inset shows the tube in the “as found” condition and main photograph shows the tube after it was partially pulled out of the wall. (Moore, Oklahoma, 2013 tornado)

The TTU research also shows that a 4-inch-thick reinforced concrete roof slab on removable forms or on steel decking is able to resist a 15-pound wood 2x4 test missile impacting at 67 mph (the free-falling missile impact speed given in Table B3-3 through Table B3-5). For more detail on wall and roof assemblies that have passed the tornado missile impact test, see “Wall Sections that Passed Previous Missile Impact Tests” on the safe room website at <https://www.fema.gov/emergency-managers/risk-management/building-science/safe-rooms/resources>.

B8.2.4 DEBRIS IMPACT AND PRESSURE TESTING CRITERIA FOR IMPACT-PROTECTIVE SYSTEMS

This section addresses impact and pressure testing criteria for impact-protective systems, which include any system or device installed to protect openings in the safe room envelope. Debris impact and pressure testing criteria are specified in ICC 500 Sections 803 and 804, respectively; both sections include specific procedures for door and glazed opening (window) assemblies.

NOTE

Design Pressure versus Test Pressure

In accordance with ICC 500 Section 805.2, storm shelter static test pressure for impact-protective systems is required to be 1.2 times greater than the storm shelter design wind pressure or tornado pressure that is listed on the product label and determined in accordance with ICC 500 Section 304. Because FEMA Funding Criteria specify no additional pressure testing criteria for FEMA-funded safe rooms, the standard criteria govern both storm shelters and safe rooms.

CODES AND STANDARDS

Test Lab Accreditation: To help ensure that the impact and pressure testing specified in ICC 500 is properly conducted and reported, the testing should be conducted by testing agencies accredited in accordance with ISO/IEC 17025 to conduct the missile impact and pressure testing required in ICC 500 Chapter 8.

For safe room impact-protective systems to reliably provide life-safety protection during a tornado or hurricane, they must pass testing protocols specified in ICC 500 Chapter 8 and be manufactured consistently. (Installation and maintenance of the listed and labeled products are also vital as described in the textbox in Section B8.2.4.1.) Listing and labeling as described in Section B3.2.7 (see also “Label,” “Labeled,” and “Listed” definitions in Chapter B2) serve to certify compliant testing performance and also to ensure product consistency through audits of the manufacturer. Designers and consumers alike should carefully check impact-protective system labels and request documentation from the supplier and/or installer (as needed) to verify the assembly’s compliance with ICC 500 testing criteria in accordance with designated safe room storm type and wind speed.

Because FEMA does not specify any differences with ICC 500 for test procedures in Chapter 8, the standard criteria govern both storm shelters and safe rooms. In other words, the impact-protective system label need not reference FEMA, provided it lists compliance with the edition of ICC 500 required by FEMA HMA for the safe room project. Certified product directories¹⁸ from four third-party testing agencies are listed below to serve as resources for finding impact-protective systems that comply with ICC 500:

- **UL Online Certification Directory:** <https://iq.ulprospector.com/info/>. After registering for a free account, log into “UL Product iQ” directory and enter “ICC 500” under “Start your search” to find products that have passed testing for the appropriate edition of ICC 500.
- **Intertek Online Certification Directory:** https://bpdirectory.intertek.com/Pages/DLP_Search.aspx. Under “Standard,” select “ICC-500” from the pull-down menu and click on “Search” for a list of products that have passed testing for the appropriate edition of ICC 500.
- **National Accreditation & Management Institute (NAMI) Online Certification Directory:** https://www.namicertification.com/index.php?option=com_namicert&view=structural&Itemid=115. Under “SPECIFICATION,” select the appropriate edition of ICC 500 for compliant products.
- **ICC-Evaluation Service Directory:** <https://icc-es.org/building-products-listing-program/listing-report-directory/>. Select the “Reports Directory” tab and enter “ICC500” under “Standard” for IPS and prefabricated storm shelters.

NOTE

FEMA Approvals

FEMA does not endorse, approve, certify, or recommend any contractors, individuals, firms, or products. Contractors, individuals, or firms shall not claim they or their products are “FEMA approved” or “FEMA certified.”

B8.2.4.1 Door Assemblies

A door assembly includes the door, vision panel (if there is one), hardware (locks and hinges), frame, and attachment devices used to anchor the door frame to the safe room wall. The entire storm shelter door assembly must pass the required testing in the same configuration in which it will be installed in the storm shelter or safe room. Any change to any of these components would necessitate re-evaluation by the certifying agency and retesting in the new configuration pending re-evaluation results. Untested steel doors commonly used in residential and commercial construction

¹⁸ Because not all designers are familiar with online certification directories, the names of four agencies that provide free access directories for listed and labeled safe room products have been included. However, the list of companies is not exhaustive. Additionally, this list is not intended to express a preference for those third-party testing agencies and/or the listed and labeled products by the U.S government, nor is it an endorsement of those third-party testing agencies and/or the listed and labeled products referenced in their directories.

(refer to Figure B8-18) cannot withstand the impact of the wind-borne debris, or test missiles, that a tornado can propel, and their failure has resulted in serious injury and even death during tornadoes.

Safe Room Door Fact Sheet Series

For more information about the selection, installation, and maintenance of safe room door assemblies for community safe rooms, please see the FEMA fact sheet, *Community Tornado Safe Room Doors: Installation and Maintenance* (2021), on the safe room website or at <https://www.fema.gov/emergency-managers/risk-management/building-science/safe-rooms/resources>.

For more information and guidance on finding an adequate door for residential tornado safe rooms, please see FEMA fact sheet, *Residential Tornado Safe Room Doors* (2024d), on the safe room website or at <https://www.fema.gov/emergency-managers/risk-management/safe-rooms/resources>.

The first two editions of ICC 500 provided test procedures applicable to side-swinging doors only. Notably, the subsequent editions have added impact testing criteria for overhead rolling doors and overhead sectional doors (reference Sections 803.9.4.2 and 803.9.4.3, respectively).



Figure B8-18: This metal door was damaged by wind-borne debris generated by a weak tornado. The bottom hinge was damaged, but the single latch was able to resist the modest wind and impact load. The door was on the verge of failing. (St. Louis, Missouri, 2013 tornado)

To evaluate wind pressure resistance, door assemblies are laboratory tested with positive and negative pressures. During testing, the assemblies are configured to apply positive pressure on in-

swinging as well as out-swinging doors, thus simulating positive and negative pressures. For impact resistance testing, the door assembly is struck on the face that is intended to be on the exterior side of the safe room.

NOTE**Safe Room Doors**

Most tornado safe room doors evaluated prior to January 2000 were equipped with latching mechanisms composed of three individually activated deadbolts. Since that time, multiple latching mechanisms activated by a single lever or by a panic bar release mechanism have been tested and shown to resist the tornado wind loads and tornado test missile.

Section B5.2.5 describes further information concerning operating hardware. Door hardware manufacturers offer locks and latches with multiple functions, where the functions should be considered carefully to comply with Section 507.4 of ICC 500.

Pressure testing requirements specified in Section 306.4 of ICC 500 differ by storm type. Hurricane storm shelter impact-protective systems are subject to static and cyclic testing requirements, but tornado storm shelter impact-protective systems must only pass static testing. Consistent with testing criteria in ASTM E1886, the cyclic testing must take place on the same sample that was impact tested, whereas static pressure testing may occur on a separate assembly.

B8.2.4.2 Glazed Opening Assemblies

A glazed opening assembly includes the glazing, glazing frame, and attachment devices used to anchor the glazing frame to the wall. Wind-borne debris-resistant glazing is laminated glass, polycarbonate, or a combination of these materials. The glazing assembly installed in a safe room must use the same type, size, and configuration of materials used for the tested and listed assembly.

ICC 500 Section 803.10 stipulates pass/fail criteria for impact testing. Glazing is permitted to break, provided that (1) the test missile did not perforate the glazing, (2) ejected glass fragments did not perforate the ICC 500-required witness screen (and were, therefore, harmless), and (3) permanent deformation of the interior surface does not exceed 3 inches.

When evaluating listed and labeled glazed opening assemblies, it is important to differentiate between impact testing performed for safe rooms versus testing performed for buildings other than safe rooms located in wind-borne debris regions of hurricane-prone regions. The test missile for a hurricane safe room is the same type and size as used for other buildings in wind-borne debris regions (i.e., a 9-pound 2x4). However, the safe room missile has a much higher test speed, and hence a much higher momentum. Also, although the test missile used for other buildings is often referred to in test reports as a “large missile,” the tornado safe room missile is much larger.

NOTE**Glazing Protected by Shutters**

Hurricane safe room glazed assembly: If the glazed assembly is protected by a shutter, the shutter should be on the exterior side of the assembly to avoid water infiltration into the safe room in the event that the glazing breaks. When the shutter is installed on the exterior side of the safe room window, the glazed assembly is only required to be tested for pressure per ICC 500 Section 306.4.1, Exception 1.

Tornado safe room glazed assembly: If the glazed assembly is protected by a shutter, the shutter should be on the interior side of the assembly so that it can be closed quickly. In this case, the glazing assembly is not required to be tested for pressure or missile impact per ICC 500 Section 306.4.1, Exception 2.

The safe room shutter assembly must be installed in the same configuration—exterior or interior mounted—that passed the required testing procedures.

B8.2.4.3 Other Impact-Protective Systems

Impact-protective systems other than door and window assemblies include shutters, shields, and cowlings. Shields and cowlings are used to protect penetrations in the safe room envelope and openings at louvers, grates, grilles, plumbing vents, roof drains, emergency generator exhaust vents, and masonry control joints or precast panel joints that exceed tolerances in ICC 500 Section 306.4.3. Non-operable, permanently affixed shields and cowling that have been designed to resist design pressures may be excluded from pressure testing.

Chapter B9 References and Resources

REFERENCES

- AAWE (American Association for Wind Engineering). 2004. "Performance of Storm Shelters During Hurricanes Charley and Ivan." In the *Newsletter of the American Association for Wind Engineering*. December 2005.
- ACI (American Concrete Institute). 2019. *Building Code Requirements for Structural Concrete*. ACI 318-19. American Concrete Institute. Farmington Hills, MI.
- ACI. 2020. *Code Requirements for Residential Concrete and Commentary*. ACI-332-20. American Concrete Institute. Farmington Hill, MI.
- American Red Cross. 2002. *Standards for Hurricane Evacuation Shelter Selection*. ARC 4496.
- ANSI (American National Standards Institute) / ISEA (International Safety Equipment Association). 2015. *Minimum Requirements for Workplace First Aid Kits and Supplies*. American National Standard, ANSI/ISEA Z308.1. Arlington, VA.
- ASCE (American Society of Civil Engineers) / SEI (Structural Engineering Institute). 2010. *Minimum Design Loads for Buildings and Other Structures*. ASCE 7-10. Reston, VA.
- ASCE/SEI. 2014. *Flood Resistant Design and Construction*. ASCE 24-14. Reston, VA.
- ASCE/SEI. 2016. *Minimum Design Loads and Associated Criteria for Buildings and Other Structures*. ASCE 7-16. Reston, VA.
- ASCE/SEI. 2022. *Minimum Design Loads and Associated Criteria for Buildings and Other Structures*. ASCE 7-22. Reston, VA.
- Clemson University. 2000. *Enhanced Protection from Severe Wind Storms*. Department of Civil Engineering, Clemson University, Clemson, SC. January.
- Darwin Reconstruction Commission. 1975. *Darwin Area Building Manual*. Canberra, Australia. Available for review at <http://catalogue.nla.gov.au/Record/2764422>.
- FDEM (Florida Division of Emergency Management). 2014. *ARC 4496 – Prescriptive Summary Table*.
- FDEM. 2024. *2024 Statewide Emergency Shelter Plan*. Published biennially. <https://www.floridadisaster.org/dem/response/infrastructure/statewide-emergency-shelter-plan/>.
- FEMA Publications (all available for download from FEMA at <https://www.fema.gov/multimedia-library>). Some documents have multiple editions. The most current edition is listed as the year published and older editions are noted in the reference.

FEMA Numbered Publications:

- FEMA P-55. 2011. *Coastal Construction Manual*. August. Washington, DC.
- FEMA P-320. 2024. *Taking Shelter from the Storm: Building a Safe Room for Your Home*. Washington, DC. Earlier editions were published in 1998, 1999, 2008, 2014, and 2021.
- FEMA 342. 1999. *Midwest Tornadoes of May 3, 1999: Observations, Recommendations, and Technical Guidance*. October. Washington, DC.
- FEMA P-361. 2024. *Safe Rooms for Tornadoes and Hurricanes: Guidance for Community and Residential Safe Rooms*. Washington, DC. Earlier editions were published in 2000, 2008, 2015, and 2021.
- FEMA P-424. 2010. *Design Guide for Improving School Safety in Earthquakes, Floods and High Winds*. December. Washington, DC.
- FEMA P-431. 2009. *Tornado Protection: Selecting Refuge Areas in Buildings*. October. Washington, DC. Earlier edition was published in 2003. Update is in progress.
- FEMA P-543. 2007. *Design Guide for Improving Critical Facility Safety from Flooding and High Winds*. January. Washington, DC.
- FEMA P-577. 2007. *Design Guide for Improving Hospital Safety in Earthquakes, Floods, and High Winds*. Washington, DC.
- FEMA P-646. 2019. *Guidelines for the Design of Structures for Vertical Evacuation from Tsunamis*. August. Washington, DC.
- FEMA P-908. 2012. *Mitigation Assessment Team (MAT) Report Spring 2011 Tornadoes: April 25–28 and May 22*. Washington, DC.
- FEMA P-942. 2013. *Mitigation Assessment Team Report: Hurricane Sandy in New Jersey and New York*. Washington, DC.
- FEMA P-1020. *Formal Observation Report Tornado: Moore, Oklahoma, May 20, 2013 Safe Room Performance, Observations, and Conclusions*. August. Washington, DC.
- FEMA P-2020. 2018. *Mitigation Assessment Team Report: Hurricanes Irma and Maria in Puerto Rico*. October. Washington, DC.
- FEMA P-2021. 2018. *Mitigation Assessment Team Report: Hurricanes Irma and Maria in the U.S. Virgin Islands*. September. Washington, DC.
- FEMA P-2022. *Mitigation Assessment Team Report: Hurricane Harvey in Texas*. February. Washington, DC.
- FEMA P-2077. 2020. *Mitigation Assessment Team Report: Hurricane Michael in Florida*. February. Washington, DC.
- FEMA P-2342. 2023. *Mitigation Assessment Team Report: Hurricane Ian in Florida*. December. Washington, DC.

FEMA Non-numbered Publications:

- FEMA. 1999. *FEMA National Performance Criteria for Tornado Shelters*.
- FEMA. 2010. *Guidance on Planning for Integration of Functional Needs Support Services in General Population Shelters*. November.
- FEMA. 2013. *Alerting the Whole Community: Removing Barriers to Alerting Accessibility*. FEMA Integrated Public Alert and Warning System.

- FEMA. 2019a. *Best Available Refuge Area Assessment Guide for Puerto Rico Hurricane Wind Hazards*. FEMA Job Aid.
- FEMA. 2019b. *Planning Considerations: Evacuation and Shelter-in-Place Guidance for State, Local, Tribal, and Territorial Partners*.
- FEMA. 2020. “Safe Room Funding” (webpage). <https://www.fema.gov/emergency-managers/risk-management/building-science/safe-rooms/funding>.
- FEMA. 2024a. *Community Tornado Safe Room Doors: Installation and Maintenance*. FEMA Fact Sheet. Safe Room Series #2.
- FEMA. 2024b. *Foundation and Anchoring Criteria for Safe Rooms*. FEMA Fact Sheet.
- FEMA. 2024c. *Hazard Mitigation Assistance Program and Policy Guide*. July. Washington, DC.
- FEMA. 2024d. *Residential Tornado Safe Room Doors*. FEMA Fact Sheet. Safe Room Series #2.

FEMA/NIST (National Institute of Standards and Technology). 2023. *Design Guide for New Tornado Load Requirements in ASCE 7-22*. January. Washington, DC.

FEMA and U.S. Fire Administration. Undated. *Emergency Procedures for Employees with Disabilities in Office Occupancies*. FA 154. Washington, DC.

ICC (International Code Council). 2017a. *Accessible and Usable Buildings and Facilities*. International Code Council. ICC A117.1. Country Club Hills, IL.

ICC. 2017b. *Florida Building Code, Sixth Edition*. Country Club Hills, IL.

ICC. 2024a. *International Building Code*. Country Club Hills, IL. Earlier editions published in 2000, 2003, 2006, 2009, 2012, 2015, 2018, and 2021.

ICC. 2024b. *International Existing Building Code*. Country Club Hills, IL. Earlier editions published in 2000, 2003, 2006, 2009, 2012, 2015, 2018, and 2021.

ICC. 2024c. *International Plumbing Code*. Country Club Hills, IL. Earlier editions published in 2006, 2009, 2012, 2015, 2018, and 2021.

ICC. 2024d. *International Residential Code for One- and Two-Family Dwellings*. International Code Council. Country Club Hills, IL. Earlier editions published in 2000, 2003, 2006, 2009, 2012, 2015, 2018, and 2021.

ICC/NSSA (International Code Council / National Storm Shelter Association). 2023. *ICC/NSAA Standard on the Design and Construction of Storm Shelters*. ANSI/ICC 500-2023. Country Club Hills, IL. Earlier editions published in 2008, 2014, and 2020.

Kordi B., G. Traczuk, and G. A. Kopp. 2010. “Effects of wind direction on the flight trajectories of roof sheathing panels under high winds,” in *Wind and Structures*, Vol. 13, No. 2, 2010, pp. 145–167.

Kordi, B. and G. A. Kopp. 2011. "Effects of initial conditions on the flight of windborne plate debris," in *Journal of Wind Engineering and Industrial Aerodynamics*, 2011, pp. 601–614.

Lin, N.; Holmes, J.D.; and Letchford, C.W. 2007. "Trajectories of Wind-Borne Debris in Horizontal Winds and Applications to Impact Testing." *Journal of Structural Engineering*. 133(2).

McDonald, J.R. 1999. *Rationale for Wind-Borne Missile Criteria for DOE Facilities*, Institute for Disaster Research, TTU, September 1999.

"ME's Office Identifies OKC Woman Who Drowned In Storm Shelter," 2015. Oklahoma City, OK. News 9. May 7, 2015.

NFPA (National Fire Protection Association). 2023. National Electrical Code, NFPA 70.

Nielsen, E.R.; Herman, G.R.; Tournay, R.C.; Peters, J.M.; and Schumacher, R.S. 2015. "Double Impact: When Both Tornadoes and Flash Floods Threaten the Same Place at the Same Time." *Weather and Forecasting*. 30(6): 1673–1693.

NIST (National Institute of Standards and Technology). 2021. "Key Federal Law and Policy Documents: NTTAA & OMB A-119." <https://www.nist.gov/standardsgov/what-we-do/federal-policy-standards/key-federal-directives>.

OMB (Office of Management and Budget). 2016. *Federal Participation in the Development and Use of Voluntary Consensus Standards and in Conformity Assessment Activities*. January. Washington, DC.

Samenow, J. 2013. "Deadly El Reno, Okla. Tornado was widest ever measured on Earth, had nearly 300 mph winds." *The Washington Post*. June 4, 2013. Available at <https://www.washingtonpost.com/news/capital-weather-gang/wp/2013/06/04/deadly-el-reno-okla-tornado-was-widest-ever-measured-on-earth-had-nearly-300-mph-winds/>.

TTU (Texas Tech University). 2006. *A Recommendation for an Enhanced Fujita Scale (EF-Scale)*. Texas Tech University Wind Science and Engineering Center. Lubbock, TX.

TTU, Florida A&M University, Florida State University, and University of Florida. 2006. *A Summary Report on Debris Impact Resistance of Building Assemblies Submitted to National Institute Of Science and Technology (N.I.S.T)*. August.

Twisdale, L.A. and W.L. Dunn. 1981. *Tornado Missile Simulation and Design Methodology*. EPRI NP-2005 (Volumes I and II). Technical Report. Electric Power Research Institute, Palo Alto, CA. August.

U.S. Department of Justice. 2007. *ADA Checklist for Emergency Shelters*. Available at <https://www.ada.gov/pcatoolkit/chap7shelterchk.htm>.

- U.S. Department of Justice. 2010. *2010 ADA Standards for Accessible Design*. Available at <https://www.ada.gov/regs2010/2010ADASTandards/2010ADASTandards prt.pdf>.
- Vickery, P.J., P.F. Skerlj, and L.A. Twisdale, Jr. 2000. "Simulation of hurricane risk in the U.S. using an empirical track model," *Journal of Structural Engineering*. ASCE, Vol. 126, No. 10, October 2000.
- Vickery, P.J., J.X. Lin, P.F. Skerlj, and L.A. Twisdale, Jr., and K. Huang. 2006. "HAZUS-MH Hurricane Model Methodology. I: Hurricane Hazard, Terrain and Wind Load Modeling." *Natural Hazards Review*. ASCE, Vol. 7, No. 2, May 2006.
- Vickery, P., D. Wadhera, J. Galsworthy, J. Peterka, P. Irwin, and L. Griffis. 2010. "Ultimate Wind Load Design Gust Wind Speeds in the United States for Use in ASCE-7." *Journal of Structural Engineering*. Volume 136(5), 613–625.
- Youker, Emily. 2014. "Joplin school district readies community safe rooms for storm season." *The Joplin Globe*. April 17, 2014.

RESOURCES

- American Meteorological Society. 2024. *Glossary of Meteorology*. Online version available at <http://glossary.ametsoc.org/wiki/Welcome>.
- Batts, M.E., M.R. Cordes, L.R. Russell, J.R. Shaver, and E. Simiu. 1980. *Hurricane Wind Speeds in the United States*. NBS Building Science Series 124. National Bureau of Standards, Washington, DC. pp. 41.
- Carter, R. R. 1998. *Wind-Generated Missile Impact on Composite Wall Systems*. MS Thesis. Department of Civil Engineering, Texas Tech University, Lubbock, TX. May.
- Coats, D. W. and R.C. Murray. 1985. *Natural Phenomena Hazards Modeling Project: Extreme Wind/Tornado Hazard Models for Department of Energy Sites*. UCRL-53526. Rev. 1. Lawrence Livermore National Laboratory. University of California, Livermore, CA. August.
- Durst, C.S. 1960. "Wind Speeds Over Short Periods of Time." *Meteorology Magazine*, Number 89. pp.181-187. FEMA. 1999b. *National Performance Criteria for Tornado Shelters*. May 28.
- FEMA (Federal Emergency Management Agency). 2005. *Hurricane Charley in Florida*. FEMA P-488. April. Washington, DC.
- FEMA. 2009. *NEHRP Recommended Provisions for Seismic Regulations for New Buildings and Other Structures*. FEMA P-750. Washington, DC.
- Fujita, T.T. 1971. *Proposed Characterization of Tornadoes and Hurricanes by Area and Intensity*. *Satellite and Mesometeorology Research Project*. SMRP No. 91. University of Chicago, Chicago, IL.

- Hollister R-V School District. 2013. *Community Safe Room Operations Plan: Hollister R-V School District Site B – High School and Middle School Community Tornado Safe Room*. Hollister R-V School District, Hollister, MO.
- Holmes, J.D., C.W. Letchford, and N. Lin. 2005. "Investigations of plate-type windborne debris, Parts I and II." *Journal of Wind Engineering and Industrial Aerodynamics*, Volume 94.
- Lindbergh, C., M. R. Harlan, and J. L. Lafrenz. 1996. *Structural Evaluation of Existing Buildings for Seismic and Wind Loads*. Available at <http://cedb.asce.org/cgi/WWWdisplay.cgi?98301>.
- Kelly, D.L., J.T. Schaefer, R.P. McNulty, C.A. Doswell III, and R.F. Abbey, Jr. 1978. "An Augmented Tornado Climatology." *Monthly Weather Review*, Vol. 106, pp. 1172-1183.
- Krayer, W.R. and Marshall, R.D. 1992. *Gust Factors Applied to Hurricane Winds*. *Bulletin of the American Meteorology Society*, Vol. 73, pp. 613-617.
- Mehta, K.C. 1970. "Windspeed Estimates: Engineering Analyses." I. 22-24 June 1970, Lubbock, TX. pp. 89-103.
- Mehta, K.C. and R.R. Carter. 1999. "Assessment of Tornado Wind Speed From Damage to Jefferson County, Alabama." *Wind Engineering into the 21st Century: Proceedings, 10th International Conference on Wind Engineering*, A. Larsen, G.L. Larose, and F.M. Livesey, Eds. Copenhagen, Denmark. June 21-24. pp. 265-271.
- Mehta, K.C., Minor, J.E., and McDonald, J.R. 1976. "Wind Speed Analysis of April 3-4, 1974 Tornadoes." *Journal of the Structural Division*, ASCE, 102(ST9). pp. 1709-1724.
- Minor, J.E., J.R. McDonald, and R. E. Peterson. 1982. "Analysis of Near-Ground Windfields." *Proceedings of the Twelfth Conference on Severe Local Storms*. San Antonio, TX. January 1982. American Meteorological Society. Boston, MA.
- NAHB (National Association of Home Builders). 2002. *Wind-Borne Debris Impact Resistance of Residential Glazing*. Upper Marlboro, MD.
- NCMA (National Concrete Masonry Association). 1972. *Design of Concrete Masonry Warehouse Walls*. TEK 37. Herndon, VA.
- NCMA. 2003. *Investigation of Wind Projectile Resistance of Concrete Masonry Walls and Ceiling Panels with Wide Spaced Reinforcement for Above Ground Shelters*. NCMA Publication MR 21. Texas Tech University Wind Science and Engineering Research Center.
- O'Neil, S. and J.P. Pinelli. 1998. *Recommendations for the Mitigation of Tornado Induced Damages on Masonry Structures*. Report No. 1998-1. Wind & Hurricane Impact Research Laboratory, Florida Institute of Technology. December.

- Phan, L.T., and Simiu, E. 1998. *The Fujita Tornado Intensity Scale: A Critique Based on Observations of the Jarrell Tornado of May 27, 1997*. NIST Technical Note 1426. U.S. Department of Commerce Technology Administration, National Institute of Standards and Technology, Washington, DC. July.
- Pietras, B. K. 1997. "Analysis of Angular Wind Borne Debris Impact Loads." *Senior Independent Study Report*. Department of Civil Engineering, Clemson University, Clemson, SC. May.
- Powell, M.D. 1993. "Wind Measurement and Archival Under the Automated Surface Observing System (ASOS): User Concerns and Opportunity for Improvement." *Bulletin of American Meteorological Society*. Vol. 74, 615-623.
- Powell, M.D., S.H. Houston, and T.A. Reinhold. 1994. "Standardizing Wind Measurements for Documentation of Surface Wind Fields in Hurricane Andrew." *Proceedings of the Symposium: Hurricanes of 1992*. Miami, FL, December 1-3, 1993. ASCE, New York. pp. 52-69.
- Sciaudone, J.C. 1996. *Analysis of Wind Borne Debris Impact Loads*. MS Thesis. Department of Civil Engineering, Clemson University, Clemson, SC, August.
- TTU (Texas Tech University). 1998. *Design of Residential Shelters From Extreme Winds*. Texas Tech University Wind Science and Engineering Center, Lubbock, TX. July.
- Twisdale, L.A. 1985. "Analysis of Random Impact Loading Conditions." *Proceedings of the Second Symposium on the Interaction of Non-Nuclear Munitions with Structures*. Panama City Beach, FL. April 15-18.
- U.S. Department of Energy. 2002. *Natural Phenomena Hazards Design and Evaluation Criteria for Department of Energy Facilities*. DOE-STD-1020-2002. Washington, DC. January.
- Zain, Mohammed, A. Budek, and E. Kiesling. undated. *Size Limits for Above-Ground Safe Rooms*. Texas Tech University. Lubbock, TX.

B9.1 Storm Surge Inundation Data

The SLOSH¹⁹ model is used for hurricane evacuation and emergency management purposes. Details on the model and the NHC Storm Surge Risk Maps (linked below) can be found at <https://www.nhc.noaa.gov/nationalsurge/>.

¹⁹ Users should note that the surge elevations produced by SLOSH are referenced to the mean sea level (MSL) datum, which is a tidal datum that is different than geodetic datums (e.g., NAVD, NGVD) used for building design and construction. If not converted during the Hurricane Evacuation Study, MSL elevations will need to be converted to the geodetic datum referenced by the local building code and flood hazard map.

In order to perform detailed site evaluations, as described in Chapter B4 of this publication, storm surge extent and elevation information will be required. These may be obtained from the following sources.

1. State or local emergency management agencies should be contacted regarding the latest storm surge inundation information. Some states and communities post reports and maps (surge inundation, evacuation zones) online.
2. NOAA has mapped SLOSH storm surge inundation depths above ground for the U.S. Gulf and East Coasts, Hawaii, Southern California, and U.S. territories, including Puerto Rico, U.S. Virgin Islands, Guam, and American Samoa. Storm surge elevations for various hurricane categories can be obtained by using “NHC Storm Surge Risk Maps,” <https://experience.arcgis.com/experience/203f772571cb48b1b8b50fdcc3272e2c/page/Cate-gory-5/>, and can be used for preliminary evaluation of potential safe room sites.
3. The U.S. Army Corps of Engineers (USACE) has performed Comprehensive Coastal Studies for the North Atlantic (NACCS), the South Atlantic including Puerto Rico and the U.S. Virgin Islands (SACS), Louisiana, and Texas. USACE provides data at modeled save points throughout its study areas and reports modeled stillwater elevations and wave heights at each location across a varied number of percent annual chance recurrence intervals. The data are available from the USACE Coastal Hazards System, <https://chs.erdc.dren.mil/>.
4. The National Hurricane Program (USACE/FEMA/NOAA partnership) has produced technical data reports, surge inundation data and evacuation maps as part of many state or regional Hurricane Evacuation Studies (HES). These reports, data and maps are based on SLOSH, but may provide additional information useful in evaluating safe room sites and determining minimum safe room elevations. State/local emergency management agencies should be contacted regarding the latest HES surge inundation and elevation data. For more information, FEMA fact sheet, *Hurricane Evacuation Studies and Hurricane Planning*, can be downloaded at https://www.fema.gov/sites/default/files/documents/fema_nhp_hurricane-evacuation-studies_fact-sheet_022024.pdf.
5. FEMA’s Building Science Helpline can be contacted to assist with determining the storm surge extent and elevation for a site. FEMA’s Building Science Helpline can be reached by emailing FEMA-Buildingsciencehelp@fema.dhs.gov.

Appendices

This page left blank intentionally

APPENDIX A – ACRONYMS

ACI	American Concrete Institute
ADA	Americans with Disabilities Act
AMS	American Meteorological Society
ANSI	American National Standards Institute
APC	atmospheric pressure change
ARC	American Red Cross
ASCE	American Society of Civil Engineers
ASTM	ASTM International
BARA	Best Available Refuge Area
BCA	Benefit-Cost Analysis
BCR	benefit-cost ratio
BFE	base flood elevation
BRIC	Building Resilient Infrastructure and Communities
C&C	components and cladding
CDBG	Community Development Block Grant
CDC	Centers for Disease Control and Prevention
cfm	cubic feet per minute
CFR	Code of Federal Regulations
CMU	concrete masonry unit
CRSI	Concrete Reinforcing Steel Institute
DEM	digital elevation model
DI	Damage Indicator
DoD	Degree of Damage
DOE	(Puerto Rico) Department of Education
DOH	(Puerto Rico) Department of Housing
EF Scale	Enhanced Fujita Scale
EHPA	Enhanced Hurricane Protection Area

EMS	emergency medical services
EO	Executive Order
EOC	emergency operations center
EPDM	ethylene propylene diene monomer
F Scale	Fujita Scale
FAA	Federal Aviation Administration
FBC	Florida Building Code
FDEM	Florida Division of Emergency Management
FEMA	Federal Emergency Management Agency
FFRMS	Federal Flood Risk Management Standard
FIRM	Flood Insurance Rate Map
FIS	Flood Insurance Study
HEC-RAS	Hydrologic Engineering Center's River Analysis System
HES	hurricane evacuation shelter
HMA	Hazard Mitigation Assistance
HMGF	Hazard Mitigation Grant Program
HMO	Hazard Mitigation Officer
HUD	U.S. Department of Housing and Urban Development
HVAC	heating, ventilation, and air-conditioning
IBC	International Building Code
ICC	International Code Council
ICF	insulating concrete form
IEBC	International Existing Building Code
IFC	International Fire Code
IPAWS	Integrated Public Alert Warning System
IPC	International Plumbing Code
IPS	Impact Protection System
IRC	International Residential Code
LRFD	Load and Resistance Factor Design

MAT	Mitigation Assessment Team
m/s	meters per second
m³/s	cubic meters per second
mph	miles per hour
MRI	mean recurrence interval
MSL	mean sea level
MWFRS	main wind force resisting system
NAMI	National Accreditation & Management Institute
NAVD	North American Vertical Datum
NFIP	National Flood Insurance Program
NFPA	National Fire Protection Association
NGVD	National Geodetic Vertical Datum
NIST	National Institute of Standards and Technology
NOAA	National Oceanic and Atmospheric Administration
NSSA	National Storm Shelter Association
NTTAA	National Technology Transfer and Advancement Act
NWS	National Weather Service
O&M	operations and maintenance
o.c.	on center
OMB	Office of Management and Budget
PBD	performance-based design
PREMA	Puerto Rico Emergency Management Agency
psf	pounds per square foot
QAP	Quality Assurance Plan
RAAG	Refuge Area Assessment Guide
RDP	registered design professional
SEI	Structural Engineering Institute
SFHA	Special Flood Hazard Area
SLOSH	(National Hurricane Center's) Sea, Lake and Overland Surges from Hurricanes

SSPEOP	Storm Shelter Preparedness and Emergency Operations Plan
TORFF	tornado and flash flood
TTU	Texas Tech University
USACE	U.S. Army Corps of Engineers
U.S.C.	United States Code
USGS	U.S. Geological Survey

APPENDIX B – ACKNOWLEDGMENTS

Fifth Edition Team Members

The Federal Emergency Management Agency would like to acknowledge the significant contributions made by following individuals in developing the Fifth Edition of this publication.

FEMA

Daniel Bass, RA, CFM, FEMA Headquarters
Abdullah Ibraheem, FEMA Headquarters
Donald L. Leifheit Jr., CFM, FEMA Region 9
Erin Kehoe, FEMA Headquarters
Kirsty Morgan, FEMA Region 7
Juan Nieves, FEMA Headquarters
John “Bud” Plisich, FEMA Region 4
Mollie Rosario, FEMA Region 5
Brian Willsey, FEMA Headquarters
Pataya Scott, PhD, FEMA Headquarters, Project Lead

Project Team and Review Committee

American Society of Civil Engineers
Kayla Cameron, CDM Smith
Young Cho, AECOM
Carol Cook, AECOM
Daniel Dain, AIA, LEED AP BD+C, NSSA AP, Huckabee
Jadon W. Escarment, EIT, AECOM, Publication Manager
Laura Ghorbi, PE, CFM, AECOM
Allen Grammer, PE, Baird, Hampton & Brown
Lael Holton, AICP, PMP, AECOM
International Code Council
Samantha N. Krautwurst, PE, ENV-SP, AECOM
James G. LaDue, National Weather Service
Marc L. Levitan, Ph.D., National Institute of Standards and Technology
Lee-Ann Lyons, AECOM
Michael Nicasio, PDE, UL Solutions

Brian O'Connor, PE, CFM, CDM Smith
Glenn Overcash, PE, AECOM, Project Manager and Technical Lead
Susan Ide Patton, PG, AECOM
Manuel Perotin, PE, CFM, CDM Smith
Ivy Porpotage, AECOM
Adam Reeder, PE, CFM, CDM Smith
Billy Ruppert, AECOM
E. Scott Tezak, PE, BSCP, Atkins
Lucy Trumbull, AECOM
Darieus Zagara II, Creative Engagement Solutions
Morgan Zuniga, AECOM

Fourth Edition Team Members

The Federal Emergency Management Agency would like to acknowledge the significant contributions made by following individuals in developing the Fourth Edition of this publication.

FEMA

Daniel Bass, RA, CFM, FEMA Headquarters
Laurie Bestgen, CFM, FEMA Region VII
Christine Gaynes, FEMA Region V
Jennifer Goldsmith-Grinspoon, FEMA Headquarters
Andrew Herseth, PE, SE, FEMA Headquarters
John Ingargiola, EI, CFM, CBO, FEMA Headquarters
Donald L. Leifheit Jr., CFM, FEMA Region VI
Brian Metzger, FEMA Headquarters
Kirsty Morgan, FEMA Region VII
John "Bud" Plisich, FEMA Region IV
Brian Willsey, FEMA Headquarters
Gregory Wilson, FEMA Headquarters
Pataya Scott, EIT, FEMA Headquarters, Project Lead
Mariam Yousuf, FEMA Region IV

Project Team and Review Committee

Stuart Adams, Stantec Consulting Services Inc.

American Society of Civil Engineers

Maryam Asghari Mooneghi, PE, AECOM

James Bell, Assa Abloy Group

Harold Brooks, NOAA/National Severe Storms Laboratory

Neil Burning, CBO, International Code Council

Young Cho, AECOM

Carol Cook, AECOM, 508-Compliance

Anne Cope, Ph.D., PE, Insurance Institute for Business & Home Safety

Daniel Dain, AIA, LEED AP BD+C, Stantec Architecture Inc.

Jamie Farny, Portland Cement Association

Laura Ghorbi, PE, CFM, AECOM

Betsy Hicks, PE, CFM, AECOM

International Code Council

Christopher P. Jones, PE, Durham, NC

Samantha N. Krautwurst, PE, AECOM, Project Manager and Publication Manager

James G. LaDue, National Weather Service

Marc L. Levitan, Ph.D, National Institute of Standards and Technology

Lee-Ann Lyons, AECOM, Graphic Design Team Lead

Patrick Marsh, National Weather Service

Rachel Minnery, FAIA, American Institute of Architects

Brian O'Connor, PE, CFM, CDM Smith

Glenn Overcash, PE, AECOM, Project Manager and Technical Lead

Kimberly Paarlberg, RA, International Code Council

Susan Ide Patton, PG, AECOM, Tech Edit Team Lead

Manuel Perotin, PE, PMP, CFM, CDM Smith

Ivy Porpotage, AECOM

Adam Reeder, PE, CFM, CDM Smith

Tim Reinhold, PE, Stantec Consulting Services Inc.

Michael Rimoldi, MPA, CBO, CFM, Federal Alliance for Safe Homes, Inc.

Billy Ruppert, AECOM, Graphic Designer
Corey Schultz, AIA, LEED AP BD+C, Schultz² Architects, LLC
Randy Shackelford, PE, Simpson Strong-Tie Company, Inc.
Amy Siegel, AECOM, Technical Editor
David Stammen, PDE, UL LLC
E. Scott Tezak, PE, BSCP, Atkins
Jason Thompson, National Concrete Masonry Association
Michelle Terry, AECOM
Darius ZaGara II, Creative Engagement Solutions

Third Edition Team Members

The Federal Emergency Management Agency would like to acknowledge the significant contributions made by following individuals in developing the Third Edition of this publication.

FEMA

Daniel Bass, RA, CFM – FEMA Headquarters
John Bourdeau, Jr. – FEMA Region VI
Robert Franke – FEMA Region VII
Katy Goolsby-Brown – FEMA Region IV
Andrew Herseth, PE, SE – FEMA Headquarters
John Ingargiola, EI, CFM, CBO – FEMA Headquarters
Edward Laatsch, PE – FEMA Headquarters
Thomas Pickering, PE – FEMA Headquarters
John Plisich – FEMA Region IV
Ronald Wanhanen, PE – FEMA Region VI
Brian Willsey – FEMA Headquarters

Project Team and Review Committee

Dave Bowman, PE – International Code Council
William Coulbourne, PE – URS
Brad Douglas, PE – American Wood Council
Gary Ehrlich, PE – National Association of Home Builders
Yuriy Farber – National Storm Shelter Association
Dennis Graber, PE – National Concrete Masonry Association
Christopher Jones, PE

Omar Kapur, PE – URS
James LaDue – National Weather Service
Marc Levitan, PhD – National Institute of Standards and Technology
Philip Line, PE – American Wood Council
Julie Liptak – Stantec
Lee-Ann Lyons – URS
Brian Orr, PE – Toth & Associates, Inc.
Glenn Overcash, PE – URS
Samantha Passman, EIT – URS
Susan Ide Patton, RG – URS
Adam Reeder, PE – Atkins
Tim Reinhold, PE, PhD – Insurance Institute for Business and Home Safety
Tom Reynolds, PE – URS
Linda Roose – Iowa Homeland Security and Emergency Management
Matthew Schumann – Underwriters Laboratories
Pataya Scott, EIT – URS
Jason Senkbeil, PhD – University of Alabama (Tuscaloosa)
Randy Shackelford, PE – National Storm Shelter Association
Corey Schultz, AIA – Schultz Squared Architects, LLC
Thomas Smith, AIA, RRC, F.SEI – TLSmith Consulting Inc
John Squerciati, PE – Dewberry
T. Eric Stafford, PE – T. Eric Stafford & Associates, LLC
Larry J. Tanner, PE, RA – Texas Tech University
Scott Tezak, PE – TRC Solutions
Donn Thompson, AIA, CGP, LEED AP BD+C – Portland Cement Association
Timothy Smail – Federal Alliance for Safe Homes

Second Edition Team Members

The Federal Emergency Management Agency would like to acknowledge the significant contributions made by following individuals in developing the Second Edition of this publication. (Note: All affiliations and titles were current at the time of publication of the first edition in August 2008.)

FEMA

John Ingargiola – FEMA Headquarters

Jack Anderson – FEMA Headquarters

Marcus Barnes – FEMA Headquarters

Kent Baxter – FEMA Region VI

Daniel Catlett – FEMA Headquarters

Robert Franke – FEMA Region VII

Edward Laatsch – FEMA Headquarters

John Plisich – FEMA Region IV

Shabbar Saiffee – FEMA Headquarters

Jonathan Smith – FEMA Headquarters

Jody Springer – FEMA Headquarters

Keith Turi – FEMA Headquarters

Zachary Usher – FEMA Headquarters

Brian Willsey – FEMA Headquarters

Consultants

Scott Tezak, PE – URS

William Coulbourne, PE – URS

Bill Johnson – URS

Omar Kapur – URS

Shane Parson, PhD – URS

Bogdan Srdanovic – URS

Deb Daly – Greenhorne & O'Mara

Julie Liptak – Greenhorne & O'Mara

Jimmy Yeung, PhD, PE – Greenhorne & O'Mara

John Squerciati, PE – Dewberry

Wanda Rizer – Consultant

Project Team and Review Committee

Robert Boteler – MEMA (Mississippi)

David Bowman – International Code Council

Ronald Cook – University of Florida

Kenneth Ford – National Association of Home Builders

Dennis Graber – National Concrete Masonry Association
Christopher P. Jones, PE – Consultant
Ernst Kiesling, PhD, PE – Texas Tech University
Danny Kilcollins – Florida Division of Emergency Management
Philip Line – American Forestry and Paper Association
Marc Madden – American Red Cross
Joseph J. Messersmith –Portland Cement Association
Tim Reinhold, PhD – Institute for Business and Home Safety
William Rutherford – Clemons-Rutherford
Corey Schultz – PBA Architects, P.A.
Larry Tanner, RA, PE – Wind Science and Engineering Center, Texas Tech University
Cliff Vaughn – FlatSafe Tornado Shelters

First Edition Team Members

FEMA would also like to acknowledge the members of the Project Team for the first edition of this manual. The team comprised engineers from FEMA’s Mitigation Directorate, consulting design engineering firms, and university research institutions. All engineering and testing efforts required to complete this project were performed by the team. (Note: All affiliations and titles were current at the time of publication of the first edition in July 2000.)

FEMA

James L. Witt – Director, FEMA
Clifford Oliver, CEM, CBCP – FEMA Mitigation Directorate
Paul Tertell, PE – FEMA Mitigation Directorate

Consultants

William Coulbourne, PE – Greenhorne & O’Mara
Ernst Kiesling, PhD, PE – Wind Engineering Research Center, Texas Tech University
Daniel Medina, PhD, PE – Dewberry & Davis, LLC
Kishor Mehta, PhD, PE – Wind Engineering Research Center, Texas Tech University
Shane Parson, PhD – Dewberry & Davis, LLC
Robert Pendley – Greenhorne & O’Mara
Scott Schiff, PhD – Clemson University
Scott Tezak, PE – Greenhorne & O’Mara
The American Red Cross, Clemson University, the International Code Council® (ICC®), Texas Tech University, and the U.S. Department of Education assisted FEMA in the preparation of the

first edition of the manual by providing invaluable guidance and participating on the project Review Committee.

The following individuals made significant contributions to the first edition of the manual. (Note: All affiliations and titles were current at the time of publication of the first edition in July 2000.)

- Eugene Brislin, Jr., PE, Structural Engineer
- Wes Britson, PE, Professional Engineering Consultants
- Russell Carter, EIT, Wind Engineering Research Center, Texas Tech University
- Gene Corley, PhD, SE, PE, Construction Technology Laboratories
- David Low, PE, Greenhorne & O'Mara
- Timothy Reinhold, PhD, Clemson University
- Joseph T. Schaefer, PhD, Storm Prediction Center, National Oceanic and Atmospheric Association
- Emil Simiu, PhD, National Institute of Standards and Technology
- Larry Tanner, RA, PE, Wind Engineering Research Center, Texas Tech University

In addition to the individuals listed directly above, the following individuals also served on the Review Committee of the first edition of the manual. The committee was composed of design professionals; representatives of federal, state, and local governments; and members of public and private sector groups that represent the potential owners and operators of community shelters. (Note: All affiliations and titles were current at the time of publication of the first edition in July 2000.)

- Kent Baxter, FEMA Region VI
- Larry K. Blackledge, Blackledge and Associates Architects
- John Cochran, FEMA, United States Fire Administration
- Doug Cole, Manufactured Home Park Owner
- Glenn Fiedelholz, FEMA Preparedness, Training, and Exercise Directorate
- Robert Franke, FEMA Region VII
- John Gambel, FEMA Mitigation Directorate
- Louis Garcia, American Red Cross
- Michael Gaus, University of Buffalo
- Danny Ghorbani, Manufactured Housing Association for Regulatory Reform
- Dirk Haire, Associated General Contractors of America
- Dave Hattis, Building Technology Incorporated
- E. Jackson, Jr., American Institute of Architects

- Aziz Khondker, ESG, Inc.
- Danny Kilcollins, National Emergency Management Association
- Fred Krimgold, Virginia Tech, Northern Virginia Center
- Edward Laatsch, FEMA Mitigation Directorate
- Randolph Langenbach, FEMA Infrastructure Division
- Emmanuel Levy, Manufactured Housing Research Alliance
- John Lyons, U.S. Department of Education, Office of the Director
- Robert McCluer, Building Officials and Code Administrators International
- Rick Mendlen, U.S. Department of Housing and Urban Development, Office of Consumer Affairs
- Charles Moore, Kansas Department on Aging
- Peggy Mott, American Red Cross, Planning and Evaluation Directorate
- Mark Nunn, Manufactured Housing Institute
- Steven Pardue, FEMA Mitigation Directorate
- Jim Rossberg, American Society of Civil Engineers
- Corey Schultz, PBA Architects, P.A.
- Robert Solomon, National Fire Protection Association
- Eric Stafford, Southern Building Code Congress International, Inc.
- Dan Summers, International Association of Emergency Managers
- S. Shyam Sunder, Structures Division, National Institute of Standards and Technology
- Carol W. Thiel, Maryland Emergency Management Agency
- William Wall, International Conference of Building Officials
- Jarrell Williams, Manufactured Home Park Owner
- Soy Williams, International Code Council

The following individuals were corresponding members of the Review Committee of the first edition of the manual. (Note: All affiliations and titles were current at the time of publication of the first edition in July 2000.)

- Deborah Chapman, National Foundation of Manufactured Housing Owners, Inc.
Jim Fearing, Fearing & Hagenauer Architects, Inc.
- Daniel Gallucci, New Necessities, Inc.
- Robert Hull, Olathe School District, Kansas
- Larry Karch, State Farm Insurance Companies, Facilities Management Division

- Mark Levitan, Civil and Environmental Engineering, Louisiana State University
- Jerry McHale, Federation of Manufactured Housing Owners of Florida, Inc.
- Dick Nystrom, State Farm Insurance Companies, Facilities Management Division
- Janet Potter, National Foundation of Manufactured Housing Owners, Inc.
- Audrey Staight, American Association of Retired Persons, Public Policy Institute
- Lynn White, National Child Care Association

APPENDIX C: DESIGNER CHECKLIST

 FEMA		Checklist Safe Rooms for Tornadoes and Hurricanes using FEMA P-361, fifth edition (2024)			
Blue – User Input	Gray – Program generate		Date:		
Project Name:					
Location:					
Designer/Lead Authority		Completed by:	ICC 500 reference	FEMA P-361 reference	
1	General Design and Drawings				
2	Type of community safe room	Tornado/ Hurricane/ Combined			
3	Do the submittal documents include all applicable safe room design information and references on cover sheet?	Yes/No		Section 106.2	Section B1.2.3
4	Do the submittal documents include a statement that the safe room design conforms to the FEMA Funding Criteria in the current edition of FEMA P-361?	Yes/No			Section B1.2.3
5	Has the Quality Assurance Plan – including all inspection and structural observation schedules - been submitted?	Yes/No		Section 107	Section B1.2.4
6	Is peer review required? If yes, has the peer review report been submitted?	Yes/No		Section 108	Section B1.2.5
7	Wind Loading Identify Appropriate Safe Room Hazard Criteria				
8	Tornado Safe Room – Go to Line 15 if this is not a Tornado Safe Room				
9	What is the design tornado speed for the tornado safe room?	mph		Section 304.2 Figure 304.2	Section B3.2.5.1 Figure B3-1
11	Building enclosure classification – how was Atmospheric Pressure Change (APC) considered? A. Designed as a partially enclosed building B. Designed as an enclosed building with APC venting area in accordance with ICC 500	A or B		Sections 304.6 & 304.7	Section B3.2.5.2
12	What ASCE 7 edition and method (ASCE 7 section reference) were used in calculating MWFRS wind pressures?			Chapter 9 of ICC 500-23 requires ASCE 7-22	Section B3.2.5.2
13	What ASCE 7 edition and method (ASCE 7 section reference) were used in calculating C&C wind pressures?			Chapter 9 of ICC 500-23 requires ASCE 7-22	Section B3.2.4.2
14	Go to Line 30 (Wall and Roof Assemblies/Window and Impact Protective Systems*)				
15	Hurricane Safe Room – Go to Line 22 if this is a Tornado/Hurricane (Combined Hazard) Safe Room				
16	What is the design wind speed for the hurricane safe room?	mph		Section 304.3 Figure 304.3(1)	Section B3.2.5.1 Figure B3-2
17	What is the site exposure category?			Section 304.5	Section B3.2.5.2
18	Building enclosure classification? A. Designed as a partially enclosed building B. Designed as an enclosed building	A or B		Section 304.6	Section B3.2.5.2
19	What ASCE 7 edition and method (ASCE 7 section reference) were used in calculating MWFRS wind pressures?			Chapter 9 of ICC 500-23 requires ASCE 7-22	Section B3.2.5.2 for Directional Method
20	What ASCE 7 edition and method (ASCE 7 section reference) were used in calculating C&C wind pressures?			Chapter 9 of ICC 500-23 requires ASCE 7-22	Section B3.2.5.2

21	Go to Line 30 (Wall and Roof Assemblies/Window and Impact Protective Systems*)				
22	Tornado/Hurricane (Combined Hazard) Safe Room				
23	What is the design wind speed for tornado hazard?	mph		Section 304.2 Figure 304.2	Section B3.2.5.1 Figure B3-1
24	What is the design wind speed for hurricane hazard?	mph		Section 304.3 Figure 304.2(1)	Section B3.2.5.1 Figure B3-2
25	Have wind pressures for both hazard types been analyzed to ensure the design is capable of resisting the greatest loads applied by each?	Yes/No		Section 104.3.1	Section B3.2.5.2
26	What is the site exposure category?			Section 304.5	Section B3.2.5.2
27	Building enclosure classification – how was Atmospheric Pressure Change (APC) considered? A. Designed as a partially enclosed building B. Designed as an enclosed building with APC venting area in accordance with ICC 500 Section 304.7	A or B		Sections 304.6 & 304.7	Section B3.2.5.2
28	What ASCE 7 edition and method (ASCE 7 section reference) were used in calculating MWFRS wind pressures?			Chapter 9 of ICC 500-23 requires ASCE 7-23	Section B3.2.5.2 for Directional Method
29	What ASCE 7 edition and method (ASCE 7 section reference) were used in calculating C&C wind pressures?			Chapter 9 of ICC 500-23 requires ASCE 7-22	Section B3.2.5.2
30	Wall and Roof Assemblies/Window and Impact Protective Systems*				
31	Have the safe room wall assemblies been successfully missile impact tested for the applicable storm type? Identify impact test criteria, wall assembly construction type(s), and test report.	Yes/No		Sections 305 and 306.3	Section B3.2.6 Section B8.2.3
32	Have the safe room roof assemblies been successfully missile impact tested for the applicable storm type? Identify impact test criteria, roof assembly construction type(s), and test report.	Yes/No		Sections 305 and 306.3	Section B3.2.6 Section B8.2.3
33	Have all safe room impact protection systems* been successfully missile impact and pressure tested for the applicable storm type? Identify impact and pressure test criteria.	Yes/No		Sections 305 and 306.4	Section B3.2.6 Section B8.2.4
34	Have all safe room impact protection systems* been listed and labeled as compliant with the current edition of ICC 500 for the applicable missile impact and pressure tests?	Yes/No		Section 306.4.1.1	Section B3.2.7 Section B8.2.4
35	Other Hazards				
36	Is the safe room subject to laydown hazard?	Yes/No		Section 305.3	Section B3.2.6.5
37	If yes, has the safe room been designed to resist the minimum laydown hazard impact load?	Yes/No		Section 305.3	Section B3.2.6.5
38	Is the safe room subject to falling debris hazard?	Yes/No		Section 305.3	Section B3.2.6.5
39	If yes, has the safe room been designed to resist the minimum falling debris hazard impact load?	Yes/No		Section 305.3	Section B3.2.6.5
40	Flood Hazards				
41	Does the FIRM for the safe room site include flood elevations?	Yes/No		Section 402.3	Sections B4.2.3.1
42	Is the safe room located on a FIRM in a mapped Zone V, VE zone, or Coastal A Zone?	Yes/No		Section 402.5	Sections B4.1 & B4.2.3.1
43	Is the safe room located in a mapped floodway?	Yes/No		Section 402.3 & 402.5	Sections B4.1, B4.2.3.1 & B4.2.3.2

44	Is the safe room located in an area subject to storm surge inundation? If yes, what is the elevation corresponding with the maximum storm surge inundation associated with the maximum intensity hurricane?	Yes/No		Section 402.6	Sections B4.1, B4.2.3.1 & B4.2.3.2
45	Is the safe room located on a FIRM in a mapped A, B, or shaded X zone?	Yes/No		Section 402.6	Sections B4.1, B4.2.3.1 & B4.2.3.2
46	What is the mapped BFE (100-year flood elevation) at the site, if applicable?				
47	What is the mapped 500-year flood elevation at the site, if applicable?				
48	What is the minimum lowest floor elevation for the safe room?			Section 402.6**	Sections B4.1, B4.2.3.1 & B4.2.3.2
49	What is the (proposed) elevation of the top of the safe room's lowest floor?				
50	If the surrounding area is flooded, is access to the safe room possible?	Yes/No			Sections B4.2.2.3
51	Square Footage/Occupancy Criteria				
52	Design occupant capacity			Section 502.2	Section B5.2.1.1
53	Expected number of standing or seated occupants			Section 502.3	Section B5.2.1.1
54	Expected number of wheelchair-user occupants			Section 502.3	Section B5.2.1.1
55	Expected number of bedridden occupants			Section 502.3	Section B5.2.1.1
56	Minimum usable floor area required for design occupant capacity	sf		Section 502.4	Section B5.2.1.1
57	Total usable floor area provided	sf			
58	Method used to determine usable floor area			Section 502.4	Section B5.2.1.1
59	ADA Requirements				
60	Is the safe room accessible to individuals with access and functional needs?	Yes/No		Section 504.2	Section B5.2.2.1
61	Ventilation				
62	Is safe room ventilation provided by passive (P) or mechanical (M) methods or both (B)?	P, M, or B		Section 702.5 & 703.7	Section B7.2.6
63	Are ventilation openings protected?	Yes/No		Section 702.5.4 & 703.7.4	Section B7.2.6
64	If mechanical ventilation is relied upon for the safe room, is the ventilation rate of outdoor air at least 5 cubic feet per minute per occupant?***	Yes/No		Section 702.5.2 & 703.7.2	Section B7.2.6
65	If mechanical ventilation is relied upon for the safe room, is the mechanical equipment protected from design wind loads, debris impacts and flooding?	Yes/No		Section 702.2 & 703.2	Section B7.2.2 & B7.2.6
66	Water Closets and Lavatories				
67	Number of water closets required			Section 702.4 & 703.4	Section B7.2.3
68	Number of water closets provided				
69	Number of lavatories required			Section 702.4 & 703.4	Section B7.2.3
70	Number of lavatories provided				
71	Standby lighting and power				
72	Is standby lighting provided?	Yes/No		Section 702.8 & 703.10	Section B7.2.8
73	Is standby power required?	Yes/No		Section 702.9 & 703.11	Section B7.2.7

74	Is standby power provided?	Yes/No			
75	If standby power is needed for the safe room, is the standby power source and any associated essential components protected from design wind loads, debris impacts and flooding?	Yes/No		Section 702.2, 702.9.3, 703.2 & 703.11.4	Section B7.2.2 & B7.2.7

* IMPACT-PROTECTIVE SYSTEM. An assembly or device, subject to static or cyclic pressure and impact testing as detailed in ICC 500, installed to protect an opening in a roof, wall or floor of the storm shelter envelope.

** For community safe rooms, FEMA Funding Criteria are more conservative than ICC 500 and govern the minimum lowest floor elevation.

*** For community tornado safe rooms, FEMA Funding Criteria are more conservative than ICC 500 and govern the minimum rate of mechanical ventilation.

APPENDIX D: COMPARISON MATRIX OF DIFFERENCES BETWEEN ICC 500 REQUIREMENTS AND FEMA FUNDING CRITERIA

ICC 500 Reference	ICC 500 Requirements ^(a)	FEMA Funding Criteria ^(b)
Section 106.2 Design Information	<p>For the areas of a building designed for occupancy as a storm shelter, the following information shall be provided within the construction documents:</p> <p>A statement that the design conforms to the provisions of the ICC 500 <i>Standard for the Design and Construction of Storm Shelters</i>, with the edition year specified.</p>	<p>A statement that the design conforms to the provisions of the ICC 500 <i>Standard for the Design and Construction of Storm Shelters</i>, with the edition year specified and to the FEMA Funding Criteria of FEMA P-361, with the edition year specified.^(c)</p>
Section 302.1 Load Combinations, General	<p>The storm shelter shall be designed to resist the load combinations specified in Section 302.2 or 302.3. <i>Storm shelters</i> that are designed as combination tornado and <i>hurricane shelters</i> shall comply with requirements for both sets of load combinations using either Section 302.2 or 302.3.</p>	<p>For all residential safe rooms, only the tornado shelter load combinations specified in Section 302.2 or 302.3 are required to be applied, regardless of safe room type, tornado, hurricane, or combination.</p>
Section 304.1 Wind Loads, General	<p>Tornado loads, W_T, wind loads for hurricanes, W_H, and wind loads for storms in Alaska, W_H, shall be determined in accordance with ASCE 7, Chapters 26 through 32, except as modified by this section. For tornado loads, the procedures from ASCE 7 Section 32.1.2 shall be applicable.</p>	<p>For all residential safe rooms, only tornado loads, W_T, are required to be applied, regardless of safe room type, tornado, hurricane, or combination.</p>
Section 304.2 Design tornado speed	<p>For tornado shelters, the storm shelter design tornado speed, V_T, shall be in accordance with Figure 304.2(1).</p>	<p>For all residential safe rooms, the design tornado speed, V_T, is required to be 250 mph, regardless of geographic location and type of safe room, tornado, hurricane, or combination.</p>
Section 304.3 Design wind speed	<p>For <i>hurricane shelters</i>, the <i>storm shelter</i> design wind speed, V_H, shall be in accordance with Figure 304.3(1) through 304.3(3). For <i>storm shelters</i> in Alaska</p>	<p>For all residential safe rooms, the design tornado speed, V_T, is required to be 250 mph, regardless of geographic location and type of safe room,</p>

ICC 500 Reference	ICC 500 Requirements ^(a)	FEMA Funding Criteria ^(b)
	the <i>design wind speed</i> , V_H , shall be in accordance with Figure 304.3(4). ^(d)	tornado, hurricane, or combination.
Section 304.9, Storm shelters connected to host buildings	Where a structural element of the <i>host building</i> is connected to a storm shelter, the storm shelter shall be designed to resist the maximum force that could be transmitted to the <i>storm shelter</i> equal to the ultimate failure strength of the connection or element being connected, whichever is lower, concurrent with the other wind loads on the <i>storm shelter</i> required by Chapter 3.	Where an element or component of the <i>host building</i> is connected to a safe room, the safe room shall be designed to resist the maximum force that could be transmitted to the <i>safe room</i> equal to the ultimate failure strength of the connection or element being connected, whichever is lower, concurrent with the other wind loads on the <i>safe room</i> required by Chapter 3. ^(e)
Section 305.1 Wind-borne debris	All <i>storm shelters</i> shall be designed for the impact loads of wind-borne debris in accordance with Section 305.1.1 through 305.2.2.	For all residential safe rooms, only the tornado shelter missile criteria for a design tornado speed of 250 mph are required to be applied, regardless of safe room type, tornado, hurricane, or combination.
Section 306.4.1 Impact-protective systems	<i>Impact-protective systems</i> for use in the <i>storm shelter envelope</i> shall be tested, listed, and labeled for impact in accordance with Section 803 and static and cyclic pressure in accordance with Sections 804 and 805. Any changes to listed <i>impact-protective systems</i> , such as a change of glazing, shall require evaluation by the listing agency or retesting of the entire assembly.	For all residential safe rooms, only the tornado shelter impact test criteria of Section 803 and only the tornado shelter static pressure test criteria of Sections 804 and 805 are required to be applied, regardless of safe room type, tornado, hurricane, or combination.
Table 402.1 Storm Shelters Required to Comply with Section 402	Location of Storm Shelter: 500-year flood hazard area Type of Shelter: Community tornado shelter ICC 500: Risk Category IV facilities or serving Risk Category IV facilities	Location of Safe Room: 500-year flood hazard area Type of Safe Room: Community tornado safe room FEMA: All
Section 402.5 Storm Shelter Siting	Storm shelters shall be located outside of the following high-risk areas: 1. Coastal high-hazard areas and coastal A zones.	Safe rooms shall be located outside of the following high-risk flood hazard areas:

ICC 500 Reference	ICC 500 Requirements ^(a)	FEMA Funding Criteria ^(b)
	<p>2. Floodways</p> <p>Exception: Storm shelters shall be permitted in coastal high-hazard areas and coastal A zones where permitted by the Board of Appeals in accordance with the provisions of the International Building Code or the International Residential Code.</p>	<ol style="list-style-type: none"> 1. Coastal high-hazard areas and coastal A zones. 2. Floodways 3. For residential safe rooms, any areas subject to storm surge inundation, including coastal wave effects, associated with the maximum intensity hurricane modeled using the National Hurricane Center’s Sea, Lake and Overland Surges from Hurricanes (SLOSH) for the location where the residential hurricane safe room is to be sited. <p>Exception: Safe rooms may be permitted in <i>coastal high-hazard areas</i> and <i>coastal A zones</i> where permitted by the Board of Appeals in accordance with the provisions of the <i>International Building Code</i> or the <i>International Residential Code</i> and approved by FEMA. Community safe rooms proposed to be sited in SFHAs or the 500-year flood hazard area require successful completion of the 8-step Decision Process for Executive Order (EO) 11988, as amended, and as Provided by Title 44 of the Code of Federal Regulations Part 9.6, Decision Making Process.^(f)</p>
<p>Section 402.6.1 Minimum floor elevation of community tornado shelters</p>	<p>The lowest floor used for the <i>occupied storm shelter areas</i> and <i>occupant support areas</i> of a <i>community tornado shelter</i> shall be elevated to or above the highest of the elevations determined by all of the following:</p> <ol style="list-style-type: none"> 1. The minimum elevation of the lowest floor required by the <i>authority having jurisdiction</i>. 	<p>The lowest floor used for the <i>occupied safe room areas</i> and <i>occupant support areas</i> of a <i>community tornado safe room</i> shall be elevated to or above the highest of the elevations determined by all of the following:</p> <ol style="list-style-type: none"> 1. The minimum elevation of the lowest floor required by

ICC 500 Reference	ICC 500 Requirements ^(a)	FEMA Funding Criteria ^(b)
	<p>2. One foot (305 mm) above the <i>base flood elevation</i>.</p> <p>3. For <i>storm shelters</i> that are Risk Category IV facilities or serving Risk Category IV facilities:</p> <p>3.1. The 500-year flood elevation.</p> <p>3.2. Two feet (610 mm) above the <i>base flood elevation</i>.</p> <p>Exceptions:</p> <p>1. A <i>community tornado shelter</i> is not required to be elevated to the level required by Items 1 through 3 where all of the following are met:</p> <p>1.1. The <i>storm shelter</i> is completely within a host building that is dry floodproofed in accordance ASCE 24 to the elevation prescribed in Items 1 through 3; or the <i>storm shelter</i> is dry floodproofed in accordance with ASCE 24 to the elevation prescribed in Items 1 through 3.</p> <p>1.2. The <i>storm shelter</i> has at least one door, emergency escape opening or hatch complying with Chapter 5 that has the bottom of the opening located above the dry floodproofing elevation.</p> <p>1.3. The elevation of the floor of the <i>storm shelter</i> is not more than 36 inches below the elevation required by Items 1 through 3.</p> <p>2. Where a <i>community tornado shelter</i> is constructed within an existing host building, only item 1 shall apply.</p>	<p>the <i>authority having jurisdiction</i>.</p> <p>2. Deleted</p> <p>3. The 500-year flood elevation.</p> <p>4. Three feet (915 mm) above the <i>base flood elevation</i>.</p> <p>No Exceptions apply</p>
<p>Section 402.6.3 Minimum floor elevation of residential tornado shelters</p>	<p>The lowest floor of a <i>residential tornado shelter</i> shall be elevated to or above the highest of the elevations determined by all of the following:</p> <p>1. The minimum elevation of the lowest floor required by the <i>authority having jurisdiction</i>.</p> <p>2. One foot (305 mm) above the <i>base flood elevation</i>.</p>	<p>The lowest floor of a <i>residential tornado safe room</i> shall be elevated to or above the highest of the elevations determined by all of the following:</p> <p>1. The minimum elevation of the lowest floor required by the <i>authority having jurisdiction</i>.</p>

ICC 500 Reference	ICC 500 Requirements ^(a)	FEMA Funding Criteria ^(b)
	<p>Exception: Where a <i>residential tornado shelter</i> is constructed within an existing <i>host building</i>, only Item 1 shall apply.</p>	<p>2. Two feet (610 mm) above the base flood elevation.</p> <p>No Exceptions apply.</p>
<p>Section 402.6.2 Minimum floor elevation of community hurricane shelters</p>	<p>The lowest floor used for the occupied storm shelter areas and occupant support areas of a community tornado shelter shall be elevated to or above the highest of the elevations determined by all of the following:</p> <ol style="list-style-type: none"> 1. The minimum elevation of the lowest floor required by the <i>authority having jurisdiction</i>. 2. Two feet (610 mm) above the <i>base flood elevation</i>. 3. The 500-year flood elevation. 4. The storm surge elevation 	<p>The lowest floor used for the occupied safe room areas and occupant support areas of a community tornado safe room shall be elevated to or above the highest of the elevations determined by all of the following:</p> <ol style="list-style-type: none"> 1. The minimum elevation of the lowest floor required by the authority having jurisdiction. 2. Three feet (915 mm) above the base flood elevation. 3. The 500-year flood elevation. 4. The storm surge elevation
<p>Section 402.6.4 Minimum floor elevation of residential hurricane shelters</p>	<p>The lowest floor of a residential hurricane shelter shall be elevated to the highest of the elevations determined by all of the following:</p> <ol style="list-style-type: none"> 1. The minimum elevation of the lowest floor required by the <i>authority having jurisdiction</i>. 2. The 500-year flood elevation. 3. The <i>storm surge elevation</i>, including coastal wave effects. 	<p>The lowest floor of a residential hurricane safe room shall be elevated to the higher of the elevations determined by all of the following:</p> <ol style="list-style-type: none"> 1. The minimum elevation of the lowest floor required by the <i>authority having jurisdiction</i>. 2. The 500-year flood elevation. 3. Not applicable.^(g) 4. Two feet (610 mm) above the base flood elevation.
<p>Section 603.1 Fire-Resistant Rated Construction</p>	<p>Walls and horizontal assemblies between <i>community storm shelters</i> and <i>host building</i> areas shall be fire barriers or horizontal assemblies with a minimum fire-resistance rating of 2 hours constructed in accordance with the <i>applicable code</i>.</p> <p>Exceptions: Walls and horizontal assemblies are not required to be fire-</p>	<p>Walls and horizontal assemblies between <i>community safe rooms</i> and <i>host building</i> areas shall be fire barriers or horizontal assemblies with a minimum fire-resistance rating of 2 hours constructed in accordance with the <i>applicable code</i>.</p>

ICC 500 Reference	ICC 500 Requirements ^(a)	FEMA Funding Criteria ^(b)
	<p>resistance rated with any of the following configurations:</p> <ol style="list-style-type: none"> 1. Design occupant capacity of 16 or fewer. 2. Storm shelter is located in the basement or underground, the design occupant capacity is less than 50, at least two egress doors are provided and the egress doors are separated by a minimum horizontal distance equal to $\frac{1}{3}$ of the overall diagonal dimension of the storm shelter. 3. Design occupant capacity is less than 50 and an egress door, overhead hatch or emergency escape opening opens directly to the exterior of the building. 4. Means of egress is designed in accordance with the applicable code for the design occupant capacity, the storm shelter has at least two egress doors and at least at 50% of the total required capacity for the means of egress from the storm shelter is directly to the exterior of the building. 	<p>No exceptions apply.^(h)</p>
<p>Section 702.5.2. Mechanical ventilation.</p>	<p>Mechanical ventilation. <i>Tornado shelters</i> that rely on mechanical ventilation shall be provided with the minimum mechanical ventilation rate of required outdoor air at a minimum rate of 2.5 cubic feet per minute (0.00118 m³/s) per occupant for the <i>design occupant capacity</i>. The mechanical ventilation system shall be connected to a standby power system.</p>	<p>Mechanical ventilation. <i>Tornado safe rooms</i> that rely on mechanical ventilation shall be provided with the minimum mechanical ventilation rate of required outdoor air at a minimum rate of 5 cubic feet per minute (0.00236 m³/s) per occupant for the <i>design occupant capacity</i>. The mechanical ventilation system shall be connected to a standby power system.⁽ⁱ⁾</p> <p>Exception: The minimum mechanical rate of ventilation for tornado safe rooms shall be permitted to be decreased to less than 5 cubic feet per minute per occupant but not less than 2.5 cubic feet per minute per occupant provided the safe room project's</p>

ICC 500 Reference	ICC 500 Requirements ^(a)	FEMA Funding Criteria ^(b)
		mechanical engineer submits a sealed letter with the submittal documents stating the specified minimum mechanical ventilation rate has been analyzed and deemed sufficient to support healthy respiration for the intended population at the design occupant capacity for a minimum of 2 hours.
<p>Section 703.11.5, Location</p> <p>Strike through text begins.</p>	<p>Location. Standby power supply shall be accessible by a protected access route. The access route shall be located within the hurricane shelter or shall meet the provisions for exterior wall and roof impact protective systems in accordance with this standard.</p> <p>Strike through text ends.</p>	<p>Location. Standby power supply shall be accessible by a protected access route. The access route shall be located within the community hurricane safe room or shall meet the provisions for exterior wall and roof impact-protective systems in accordance with this standard.⁽ⁱ⁾</p>

Bolded text denotes differences between the ICC 500 Requirement and the FEMA Funding Criteria. Strikethrough text shows requirements from ICC 500-2020 that was removed in ICC 500-2023.

Notes:

- (a) ICC 500 language reprinted here with permission from the International Code Council.
- (b) Table only lists requirements where there are differences between FEMA Funding Criteria and ICC 500 Chapters 1, 3, 4, 6, and 7. All ICC 500 Chapter 1, 3, 4, 6, and 7 requirements not listed in the table should also be met in their entirety. Safe room types (e.g., community, residential, tornado, hurricane) outside the scope of any given FEMA Funding Criterion need only meet the corresponding ICC 500 criteria (where applicable).
- (c) Noted FEMA Funding Criteria apply to all safe rooms except residential prefabricated safe rooms listed and labeled to comply with ICC 500-2023 for the design tornado speed of 250 mph in accordance with ICC 500 Figure 304.2.
- (d) ICC 500 tornado storm shelter design wind speeds range from 130 mph to 250 mph; the range for hurricane storm shelters is 160 mph to 235 mph; the range for storm shelters in Alaska is 130 mph to 185 mph.
- (e) The noted FEMA Funding Criteria apply to all safe rooms.
- (f) The FEMA Funding Criteria for the ICC 500 flood siting exception apply to all FEMA-funded safe rooms seeking a flood siting exception to ICC 500 Section 402.5.
- (g) Corresponding ICC 500 requirement is not applicable because residential safe rooms should not be located in areas subject to storm surge inundation associated with the maximum intensity hurricane.
- (h) The noted FEMA Funding Criteria apply to community safe rooms only. Neither residential storm shelters nor residential safe rooms are required to comply with ICC 500 Section 603.1.
- (i) The noted FEMA Funding Criteria apply to community and residential tornado safe rooms only. FEMA-funded community and residential hurricane safe rooms must comply with ICC 500 Section 703.7 for ventilation (no FEMA Funding Criteria apply).
- (j) The noted FEMA Funding Criteria apply to FEMA-funded hurricane community safe rooms only. There are no ICC 500 requirements for standby power for residential storm shelters or safe rooms and no ICC 500 requirements for the location of standby power for community tornado storm shelters or safe rooms.



FEMA